

1.2A, Step-Down Converter with 1.4Mhz Switching Frequency

Description

The AP5100WG-EVM is an evaluation board for the current mode step-down converter with a built-in power MOSFET.

The AP5100 enables a constant output current of up to 1.2A over a wide input supply range from 4.75V to 24V. It provides excellent line

regulation, load regulation and transient response over the operating input voltage and temperature range.

The AP5100 is self-protected, through a cycle-by-cycle current limiting algorithm and an on-chip thermal protection. The AP5100 is available in SOT26 package.

Applications

- Distributed Power Systems
- Battery Charger
- Pre-Regulator for Linear Regulators
- WLED Drivers

Performance Spec of AP5100WG-EVM

Parameter	Conditions	Performance Value
Input voltage		12V
Output Current		1.2A
Output Voltage		3.3V
Output Voltage Ripple		30mVp-p
Transient Response	Peak Deviation Load step 0.2 to 0.8 v/us	50mV
Switching Frequency		1.4Mhz
Efficiency		88%

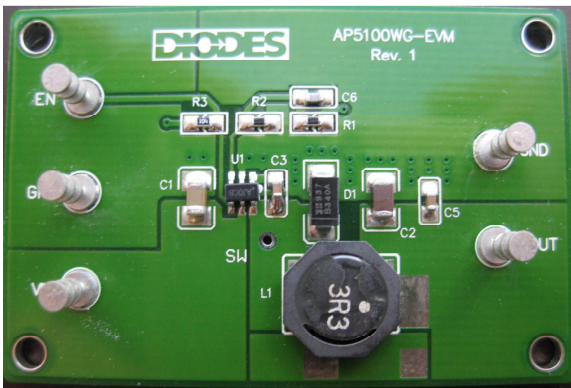

Figure 1. Evaluation Board

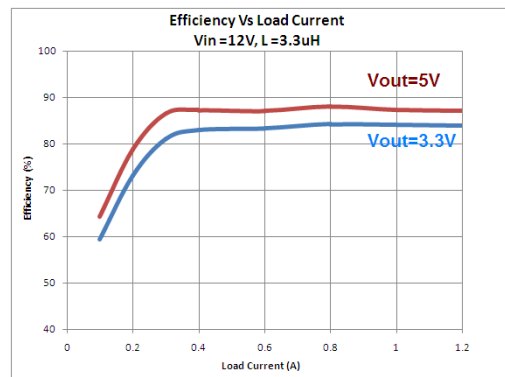

Figure 2. Efficiency vs Load Current

Quick Start Guide

The EV-AP5100 has a simple layout and allows access to the appropriate signals through test points. To evaluate the performance of the AP5100, follow the procedure below:

1. Connect a power supply to the input terminals Vin and GND. Set Vin to 12V.

Note : Vin ranges from 4.75V to 24V.

2. Connect the positive terminal of the electronic load to Vout and negative terminal to GND.
3. EN has a positive voltage through a 100K pull-up to Vin. No supply input is required for EN.

Note: To use the EN function drive EN above 1.3V to start the converter and below 0.4V to stop the converter.

4. The evaluation board should now power up with a 3.3V output voltage.
5. Check for the proper output voltage of 3.3V (+/-1%) at the output terminals Vout and GND. Measurement can also be done with a multimeter with the positive and negative leads between Vout and GND.
6. Set the load to 1.2A through the electronic load. Check for the stable operation of the SW signal on the oscilloscope. Measure the switching frequency. A test point is conveniently located at the head of the inductor.

Note: A 300mA load current is required to run the converter in continuous mode. Use an electronic load to supply the load current.

Measurement/Performance Guidelines:

- 1) The evaluation board has the inductor pad spaced for easy access to the inductor current. As shown in the picture, a current probe can be connected to the wire loop to measure the inductor current.

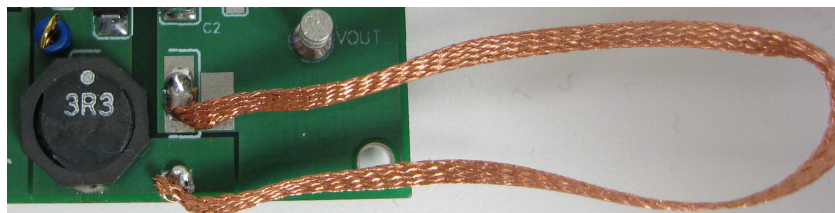

- 2) When measuring the output voltage ripple, avoid long ground leads on the oscilloscope probe.
- 3) For efficiency measurements, connect an ammeter in series with the input supply to measure the input current. Connect an electronic load to the output for output current.
- 4) A 100pF capacitor is used in parallel with the feedback resistor divider network. This component ensures best performance at low temperatures.

EVALUATION BOARD SCHEMATIC

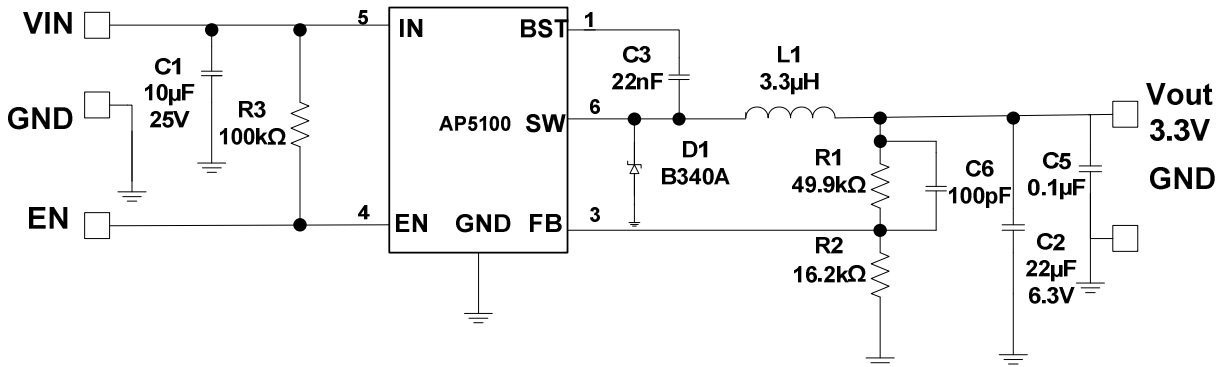

BILL OF MATERIALS

QTY	REF	VALUE	DESCRIPTION	PACKAGE	MANUFACTURER	MANUFACTURER P/N
1	C5	0.1uF	Ceramic Capacitor, 50V, X7R	0603	TDK	C1608X7R1H104K
1	C1	10uF	Ceramic Capacitor, 25V, X5R	1206	Murata	GRM31CR61E106KA12L
1	C3	22nF	Ceramic Capacitor, 50V, X7R	0603	TDK	c1608X7R1H223K
1	C2	22uF	Ceramic Capacitor, 6.3V, X5R	1206	TDK	C3216X5R0J226M
1	C6	100pF	Ceramic Capacitor, 50V, X7R	0603	TDK	C1608COG1H101J B
1	D1	B340A	Diode Schottky, 40V, 3A	SOD-123	Diodes Inc	1N5819HW-7
1	L1	3.3uH	Inductor, 5.6A	SMD	Würth	7440650033
1	R1	49.9k	Resistor, 1%	0603	Panasonic	ERJ-3EKF4992V
1	R2	16.2k	Resistor, 1%	0603	Panasonic	ERJ-3EKF1622V
1	R3	100k	Resistor, 1%	0603	Panasonic	ERJ-3EKF1003V
1	U1		DC/DC Converter	TSOT-26	Diodes Inc	AP5100

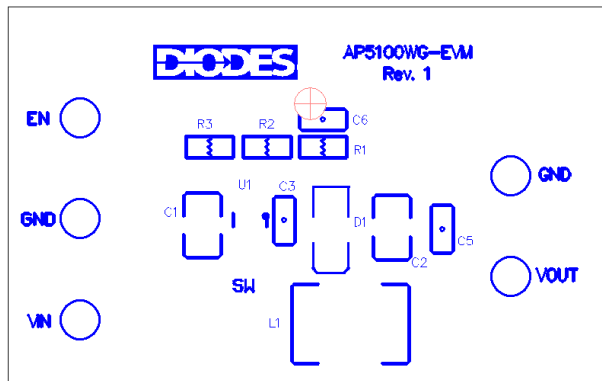

TOP SILK LAYER

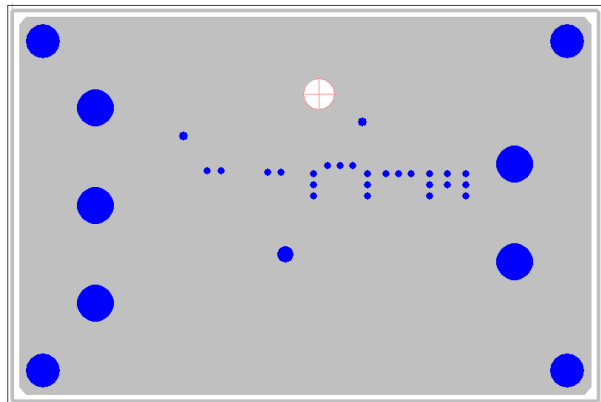

BOTTOM LAYER

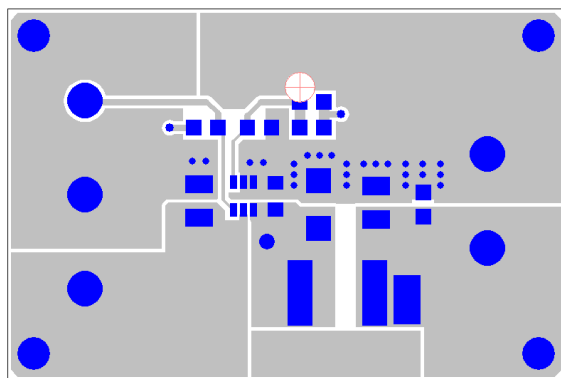

TOP LAYER