

PI2EQX58xx

Going the Distance with PCIe Gen2.0 using the PI2EQX58xx ReDriver Family

By Joseph Spisak

Introduction

The PI2EQX58xx family, consisting of the PI2EQX5804 and PI2EQX5864, was developed using Pericom's cutting-edge ReDriver™ technology to boost the high-speed differential signals traveling through traces or cables in high-performance systems. These devices were designed specifically for PCI Express 1.0 and 2.0 up to 5.0Gbps. Pericom also designs specific devices to improve signal integrity for protocols such as DisplayPort, HDMI, XAUI, SATA, SAS, USB3.0, etc..

The PI2EQX58xx family has flexible and programmable settings for its equalization, de-emphasis, and transmitter level to fit various lengths of trace and cable. It has programmable equalization from 0db, 1.2db, 1.5db, 2.6db, 4.4db, 5.8db, 7.1db, 9.0db, to 12.3db; programmable signal-swing from 0.5V, 0.7V, 0.9V to 1.0V and programmable de-emphasis at 0db, -2.5db, -3.5db, -4.5db, -5.5db, -6.5db, -7.5db, to -8.5db.

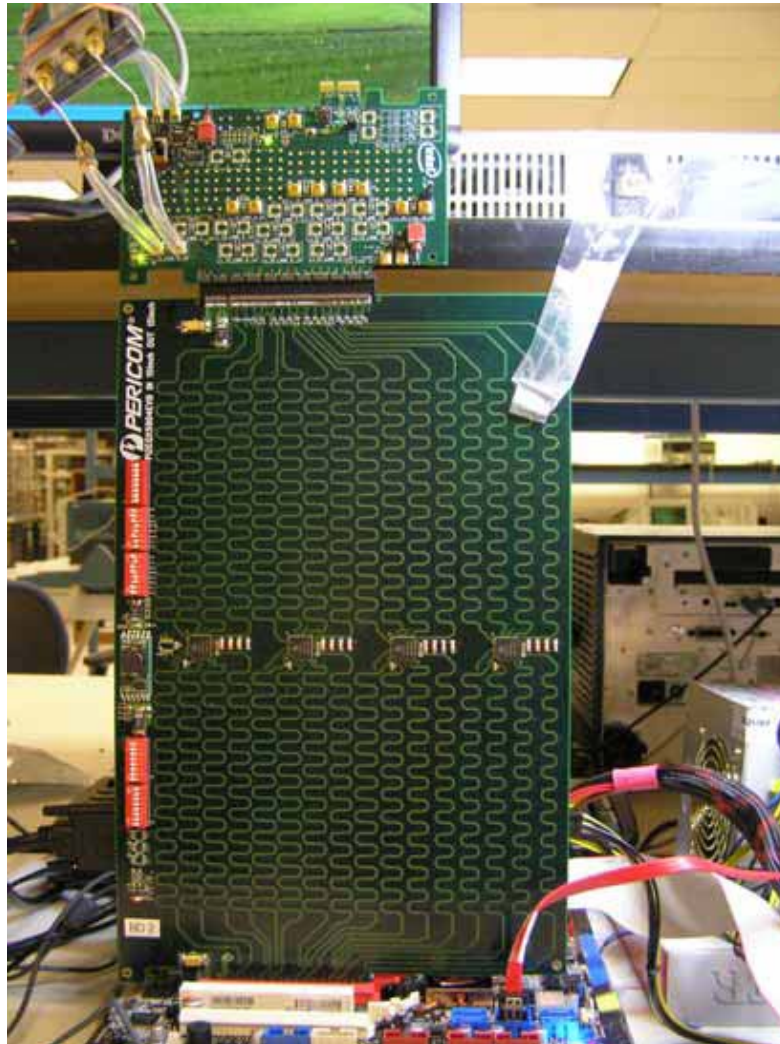

Figure 1: PI2EQX5804C system evaluation board for PCI Express x16 application supporting 30" trace length

Beating the Distance Challenge

High-speed differential signal interfaces dominate today's high-performance system architectures because of their ultra-high data rate throughput, low power consumption, facilitation of PCB layout, and PCB cost reduction. The challenge is that at the bandwidth of 5.0Gbps and beyond, the differential signals are tremendously attenuated and distorted when traveling through a long trace or cable. Pericom Semiconductor has developed a ReDriver™ device with programmable de-emphasis and equalization that will boost the signal over long distances, and will recover the distorted signal received from a long trace or cable. The example in Figure 1 uses 4 pieces of Pericom PI2EQX5804 ReDriver chips for the PCI Express x16 graphic system supporting at least 30 inches of trace length.

Figure 2 is the compliance test results using the SigTest 2.0 software and the CLB (Compliance-test Load Board) test fixture from PCI-SIG, which is developed by Intel. The Rx eyes measured at the upper graphic card connector shown on page 1 in Figure 1 are wide open with fairly low jitter after 30" trace and still meets the PCI Express compliance test specification.

Different approaches to extend a trace or cable include using a PCI Express Bridge or a Packet Switch, or by using the PI2EQX58xx Re-Driver family. PI2EQX58xx is an optimized cost-to-function solution for trace and cable extension applications.

A PCI Express Bridge or a PCI Express Packet Switch will cost much more than using the PI2EQX family, and the extended functions in the PCI Express Bridge or Packet Switch may not be fully used if the application is only for trace and cable extension.

The design cycle and design effort of using a PCI Express Bridge or a PCI Express Packet switch is also a great deal longer than using a PI2EQX58xx ReDriver, if the application is only for trace and cable extension.

Most PCI Express Bridge and Packet Switches have fixed de-emphasis at 3.5db with no equalization, while the PI2EQX58xx ReDriver family has flexible programmable signal swing, de-emphasis, and equalization to fit any lengths of trace or cable within the spec and guaranteed passing of the PCI Express compliance test.

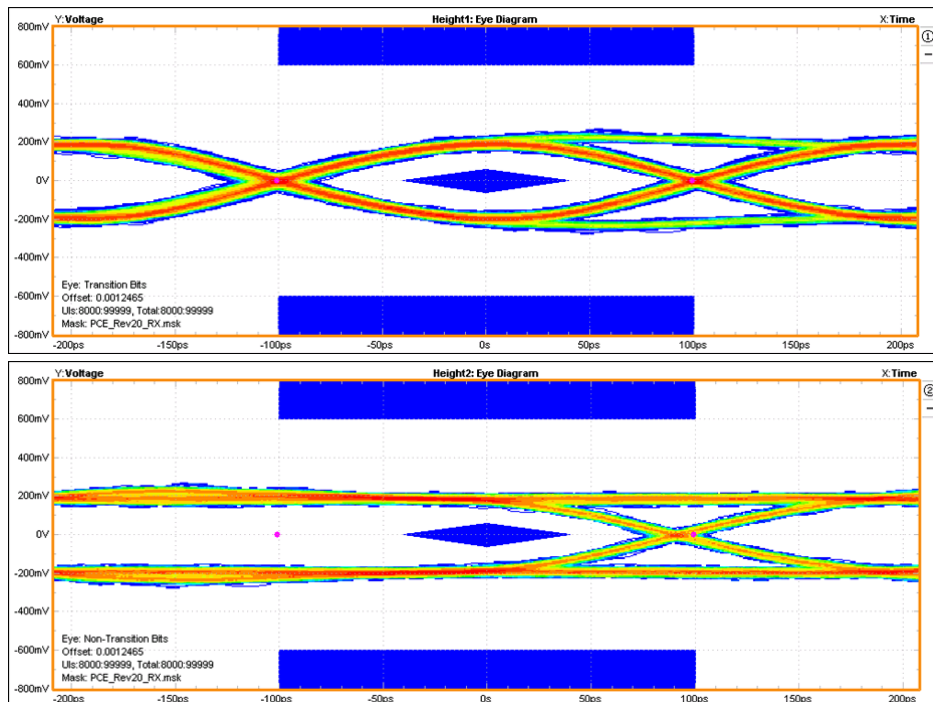

Figure 2: The transition (top) and non-transition (bottom) eyes measured at the end of the 30" trace in the system test setup shown in Figure 1

Applications using PI2EQX58xx Family

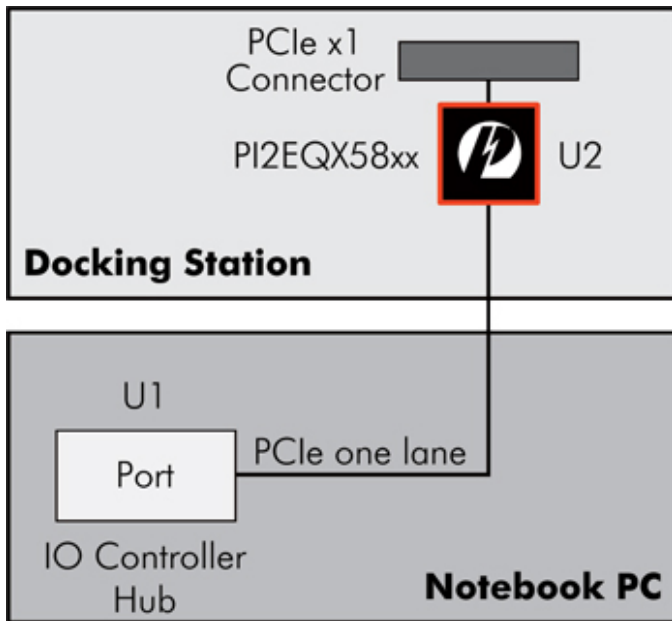

Figure 3: Using PI2EQX58xx for signal re-conditioning in the notebook and docking station

Before using the PI2EQX58xx U2 as in Figure 6, the PCI Express signal at the PCI Express x1 connector in the docking station will become weak and fail the compliance test after the signal traveling the long trace between U1 and the PCI Express x1 connector. The PI2EQX58xx in the docking station re-conditions the signal from U1 to meet the PCI Express compliance test on the PCI Express x1 connector.

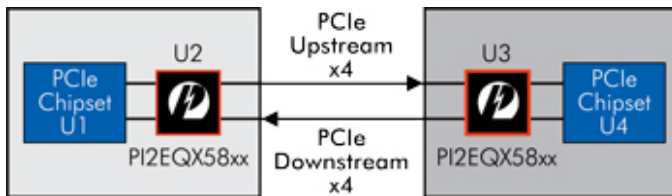

Figure 4: Using the PI2EQX58xx for the SAN (Storage Area Network) redundancy application

In Figure 4, the two SAN redundancy cards with 4 lanes PCI Express interface are 35" away from each other and the two PI2EQX58xx chips U2 and U3 are deployed at the input of PCI Express chipsets U1 and U4. Thus, the equalization in the input of the PI2EQX58xx will

recondition the messy deterministic jitter at the input of the PI2EQX58xx and the output of the PI2EQX58xx will become clear and pass the PCI Express compliance test.

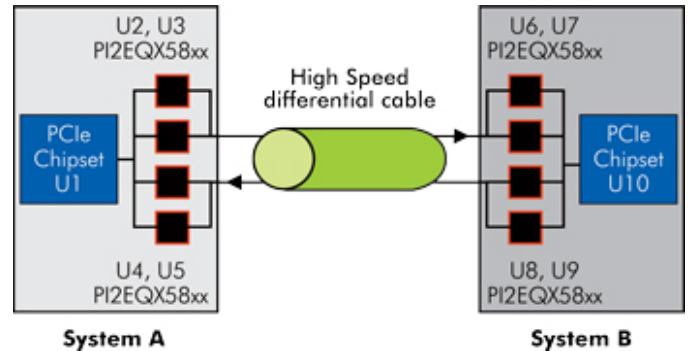

Figure 5: Using PI2EQX58xx for high-speed differential cable between two systems A and B

In Figure 5, the systems A and B are using a high-speed x16 differential cable, 3 meter to 7 meter, for PCI Express interface. The PI2EQX58xx chips U2, U3, U4, U5, U6, U7, U8, and U9 will guarantee that the signals at the input of the U1 and U10 will pass the PCI Express compliance test.

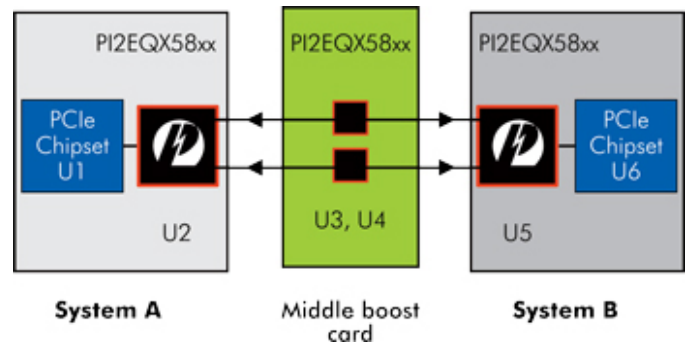

Figure 6: A middle card with PI2EQX58xx for the cable extension

If further trace and cable extension is needed, a middle card with PI2EQX58xx can be used as in Figure 6 to further extend the cable length.

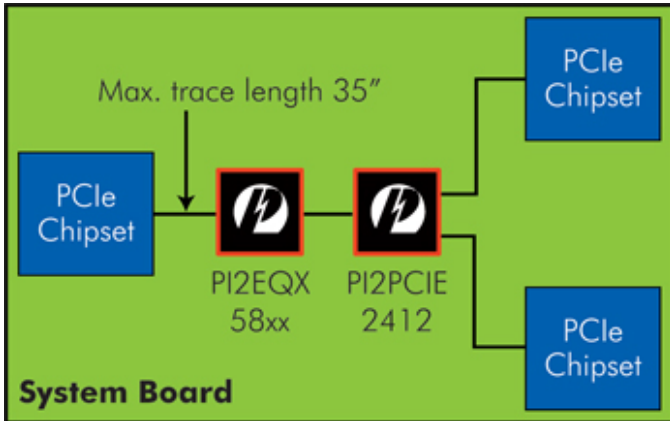

Figure 8: Using PI2PCIE2412 with PI2EQX58xx for Mux applications

Figure 8 shows the application using PI2EQX58xx combined with Pericom 2:1 Mux PCI Express switch PI2PCIE2412. The PI2PCIE2412 switch can pass the Rx PCI Express compliance test with total 8" trace as specified in the PCI Express specification. But for applications with trace longer than 8", a PI2EQX58xx can be used as in Figure 8 to guarantee that the Rx eyes at the inputs of the PCI Express chipsets will pass the PCI Express compliance test.

The recommended Settings of the PI2EQX58xx ReDriver Family

1. The Equalization settings of PI2EQX58xx for various input trace lengths:

SEL2	SEL1	SEL0	EQ at 2.5GHz (dB)	Input PCB trace Length (inch)
0	0	0	1.2	0~1
0	0	1	1.5	0~2
0	1	0	2.6	2~4
0	1	1	4.3	3~6
1	0	0	5.8	6~12
1	0	1	7.1	12~24
1	1	0	9.0	18~32
1	1	1	12.3	24~36

Input Equalization Setting using PCIe compliance test pattern:

SELx =000 (1.2dB)

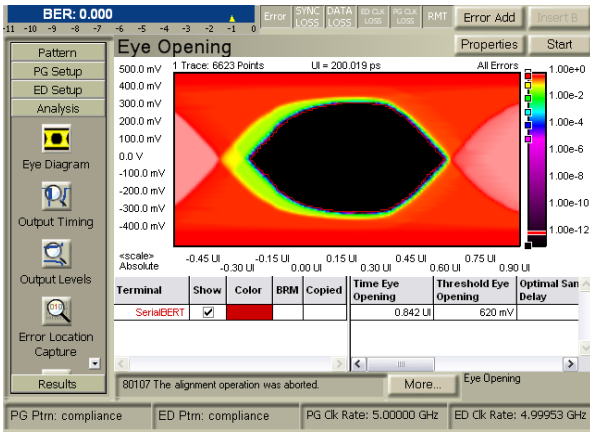

SELx =001 (1.5dB)

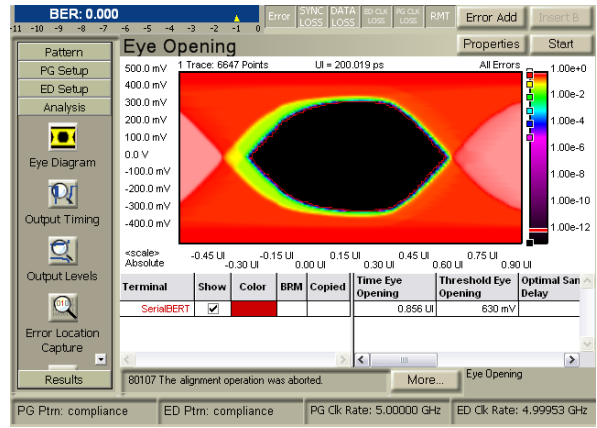

SELx =010 (2.6dB)

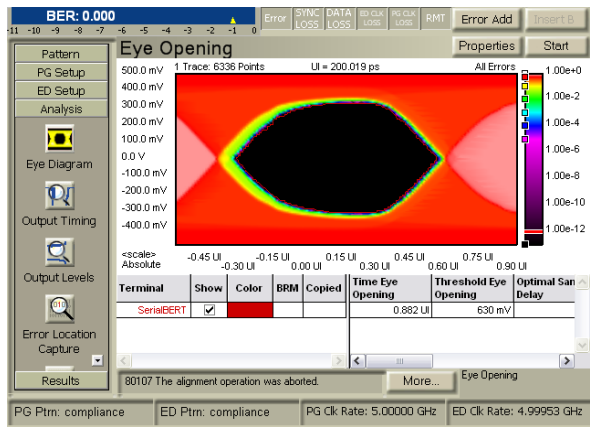

SELx =011 (4.3dB)

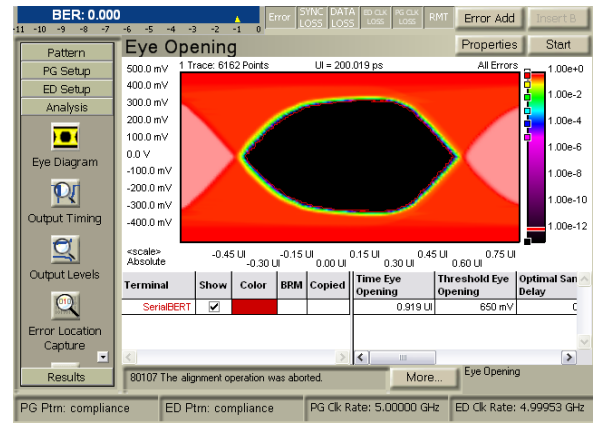

SELx =100 (5.8dB)

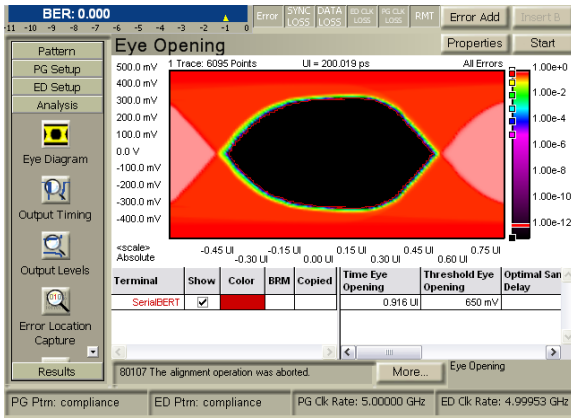

SELx =101 (7.1dB)

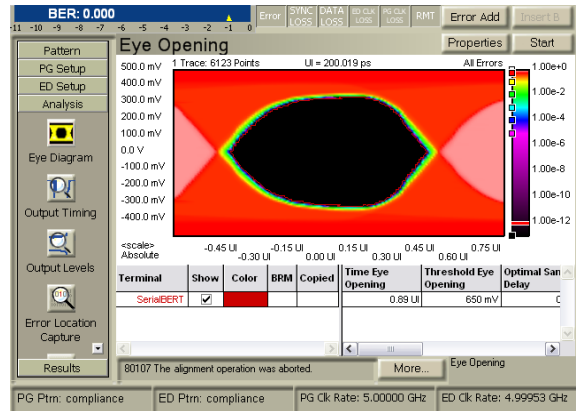

SELx =110 (9.0dB)

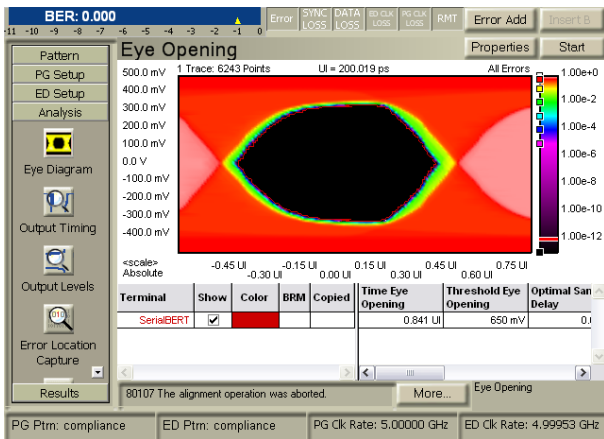

SELx =111 (12.3dB)

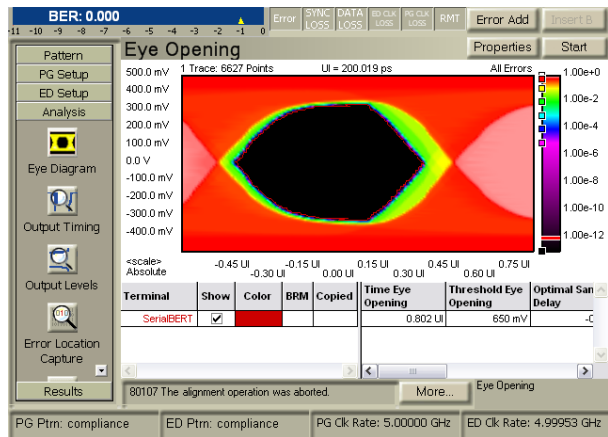

2. The Voltage Swing settings of PI2EQX58xx for various output trace lengths:

S1	S0	Swing (Vpp)	Output PCB trace Length (inch)
0	0	1.0	0~15
0	1	0.5	Low EMI use
1	0	0.7	Low EMI use
1	1	0.9	0~15

Swing Control Setting using clock pattern:

Sx=00 (1V)

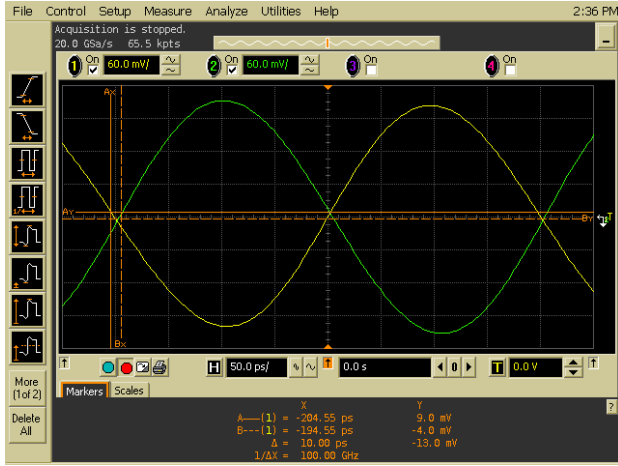

Sx=01 (0.5V)

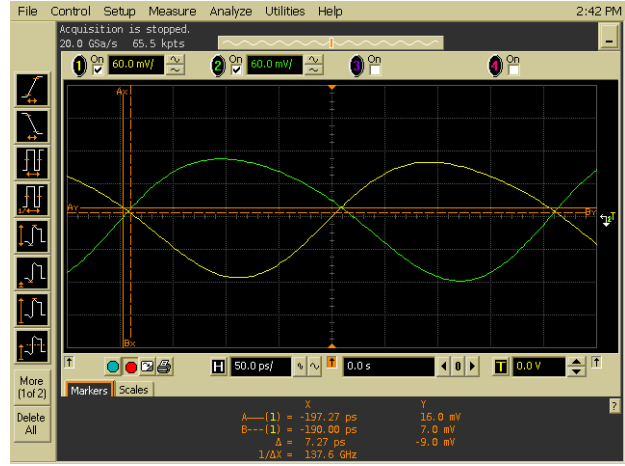

Sx=10 (0.7V)

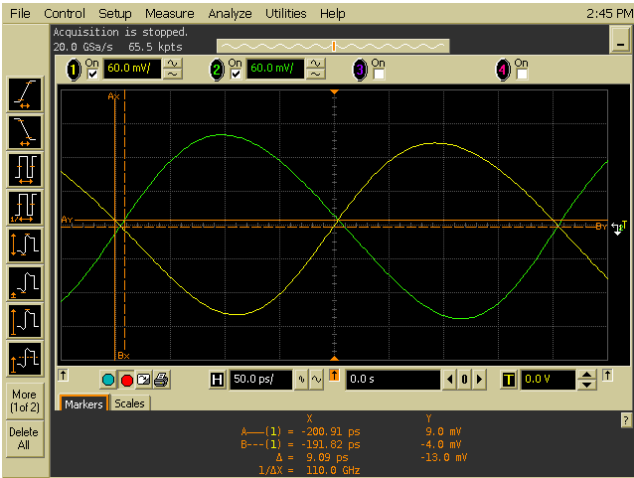

Sx=11 (0.9V)

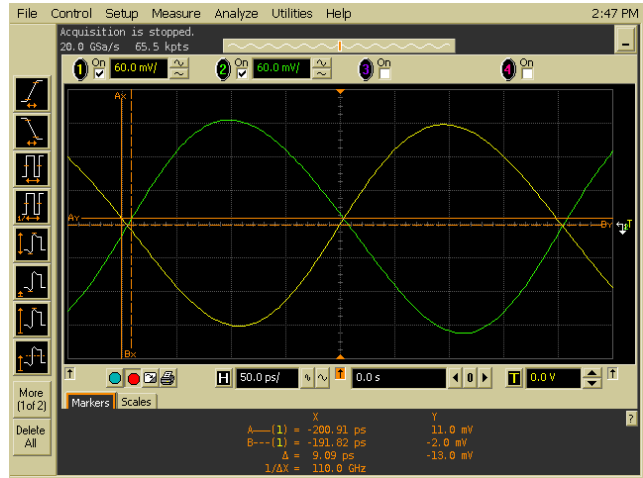

3. The De-Emphasis settings of PI2EQX58xx for various output trace lengths:

D2	D1	D0	De-Emphasis (dB)	Output PCB trace Length (inch)
0	0	0	0	0~4
0	0	1	2.5	0~4
0	1	0	3.5	4~8
0	1	1	4.5	8~15
1	0	0	5.5	N/A
1	0	1	6.5	N/A
1	1	0	7.5	N/A
1	1	1	8.5	N/A

Output De-emphasis using PCIE compliance test pattern:

Dx=000 (0dB)

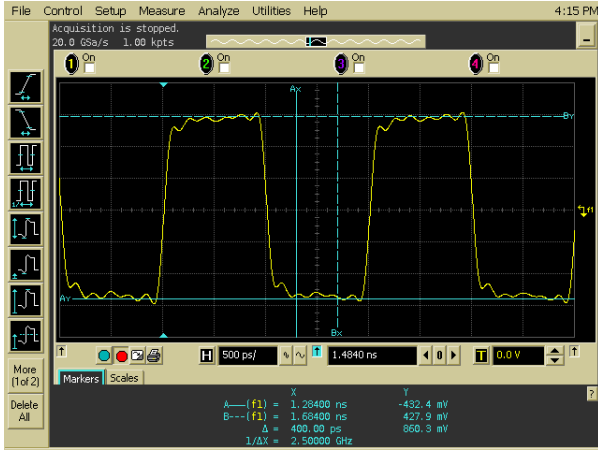

Dx=001 (-2.5dB)

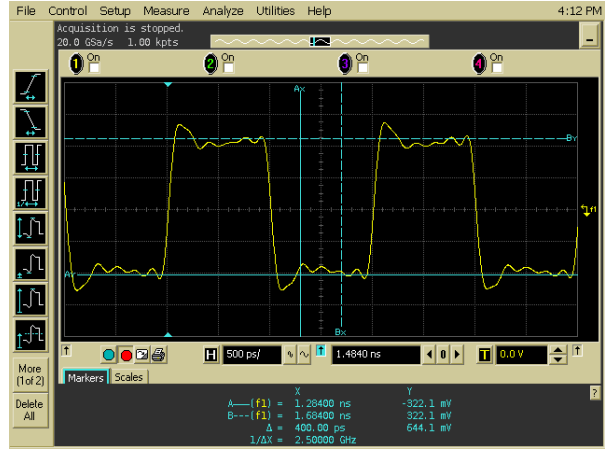

Dx=010 (-3.5dB)

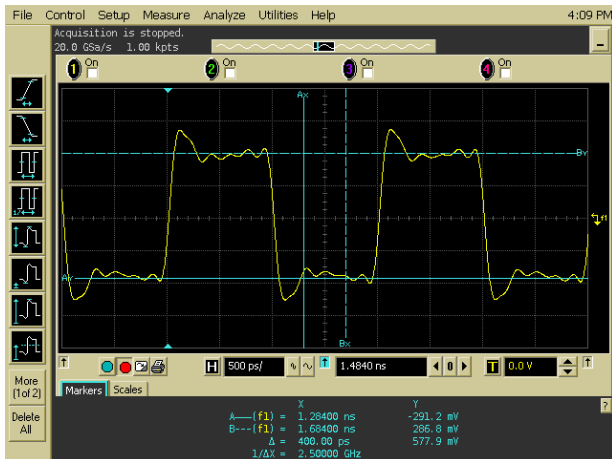

Dx=011 (-4.5dB)

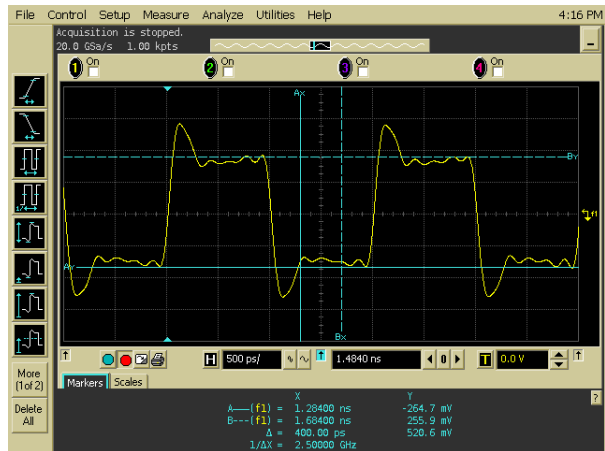

Dx=100 (-5.5dB)

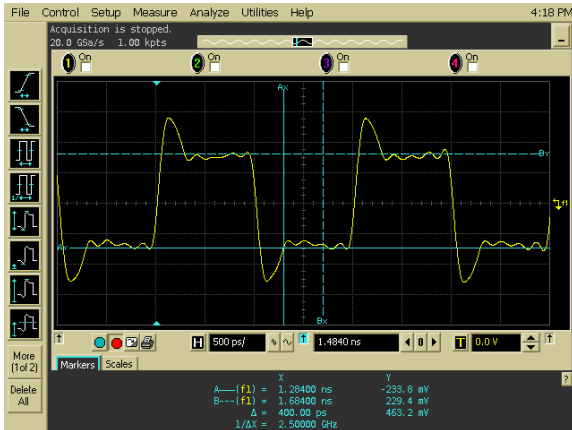

Dx=101 (-6.5dB)

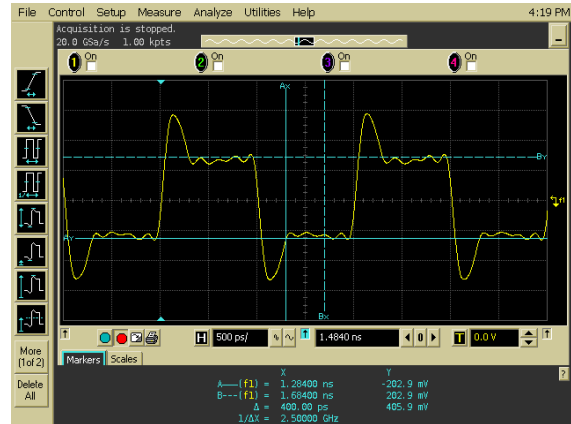

Dx=110 (-7.5dB)

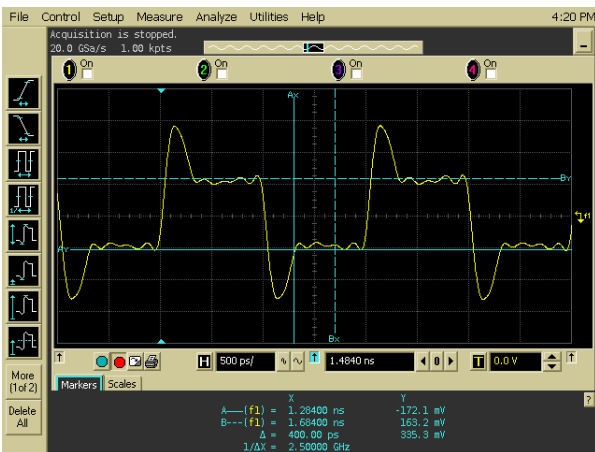

Dx=111 (-8.5dB)

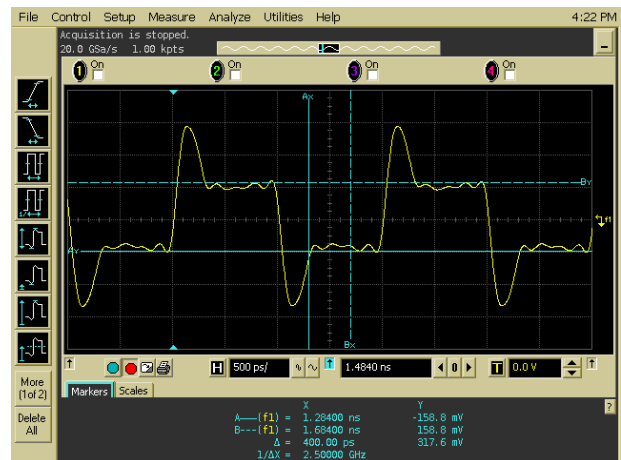

Note For cable applications, use the same settings in the above tables and multiply the trace length by 2.5 to 5, depending on the cable type.**

Conclusion

Pericom has a complete solution for the PCI Express application, including the PI2EQX44xx and PI2EQX58xx Re-Driver families, the PI2PCIE PCI Express Signal Switch family and other PCI Express products that are industry proven and shipping in volume applications. Pericom is recognized in the industry as a technology leader in high-speed differential switching and signal conditioning. Pericom is the first to develop the PCI Express 2.0 PI2EQX58xx ReDriver family with such a rich feature set and unparalleled flexibility. For a private

demo or to speak in more detail regarding these or any other Pericom products, please contact your local sales representative.