

PRODUCT CARTON SPECIFICATION

Outer/Inner Cartons, Designs & Camera Ready Art

OUTER CARTON SPECIFICATIONS

OUTER CARTON							
PRODUCT DESCRIPTION	HEIGHT (H)		WIDTH (W)		LENGTH (L)		CARTON TYPE
	inches	Mm	inches	mm	inches	mm	
5KP, 5KW, 5W, DO-15, DO-41, DO-201, DO-201AD, R6, T1 (Tape and Reel form)	13.38	340	13.38	340	13.38	340	A
D2PAK	14.25	360	13.75	350	13.75	350	A
DF-M	12.50	315	13.00	330	19.75	500	B
DF-S	11.25	285	14.5	368	14.5	368	A
DO-15, DO-41, A-405 (Bulk form)	9.88	250	8.25	210	17.75	450	B
DO-201 / DO-201AD / R6 (Bulk form)	11.00	280	13.00	330	13.50	342	A
GBJ, GBU	11.02	280	8.27	210	20.08	510	B
HD	11.25	286	14.5	368	14.5	368	A
KBPC, GBPC, MP, MB	8.25	210	11.38	290	13.00	330	A
KBJ	9.63	245	9.06	230	22.44	570	B
KBP	11.25	285	10.38	265	22.44	570	B
PBL, RS4	12.08	315	11.38	290	13.00	330	A
PBP	11.75	300	13.00	330	13.00	330	A
PBPC-3/6A	11.75	300	13.00	330	13.00	330	A
PBPC-8/10A	12.25	310	8.25	210	17.75	450	B
PBU, RS6	6.5	178	13.5	343	13.5	343	A
TO-3P, TO247	10.50	265	9.00	230	22.63	575	B
WOG	11.38	290	13.12	333	14.25	363	A

1. All cartons must meet Rule 41 of the Uniform Freight Classification.
2. All cartons must not exceed 35 lbs. on weight.
3. All carton printing must be from supplied camera ready art (refer to figures 1-4 of this specification).
4. Printed carton color must be Black.
5. Dimension tolerance is $\pm 0.20"$ or $\pm 5.0\text{mm}$.
6. General carton design types A and B must be followed. Due to varying carton shapes, it may be necessary to scale or reposition design elements to match general format.
7. Carton samples or layout must be submitted to Quality Assurance prior to first article shipment.
8. Product Packaging will periodically be inspected for compliance to this specification.

INNER CARTON SPECIFICATIONS

INNER CARTON							
PRODUCT DESCRIPTION	HEIGHT (H)		WIDTH (W)		LENGTH (L)		MAXIMUM QUANTITY
	inches	mm	inches	mm	inches	mm	
D2PAK	1.50	38	13.50	343	13.38	340	800
DF-M / DF-S (Tube)	6.00	152	6.50	165	19.50	495	5,000
DF-S (Tape)	1.13	29	13.25	337	13.25	337	1,500
DO-15, DO-41, A-405 (Bulk form)	0.90	23	3.38	86	7.88	200	1,000
DO-201AD, R6 (Bulk form)	1.50	38	3.00	76	12.00	305	500
DO-35	3.75	95	14.88	378	14.50	368	10,000
GBJ, GBU	4.92	125	7.28	185	19.09	485	600
HD	1.63	41	13.50	343	13.38	340	6,000
KBJ	5.00	127	8.25	210	22.00	559	1,000
KBP	5.50	140	9.50	241	22.00	559	3,500
MELF	1.50	38	13.25	337	13.25	337	10,000
MiniDIP	1.50	38	13.25	337	13.25	337	6,000
MiniMELF	3.00	76	7.25	184	7.25	184	12,500
SMA	1.63	41	13.50	343	13.38	340	10,000
SMB	1.63	41	13.50	343	13.38	340	6,000
SMC	2.13	54	13.50	343	13.38	340	6,000
TO-3P	5.00	127	8.00	203	21.50	546	5,000
WOG	3.25	83	6.88	175	10.00	254	1,000

1. All cartons must meet Rule 41 of the Uniform Freight Classification.
2. Dimension tolerance is $\pm 0.20\text{in.}$ or $\pm 5.0\text{mm}$.
3. Product Packaging will periodically be inspected for compliance to this specification.

OUTER CARTON – TYPE A

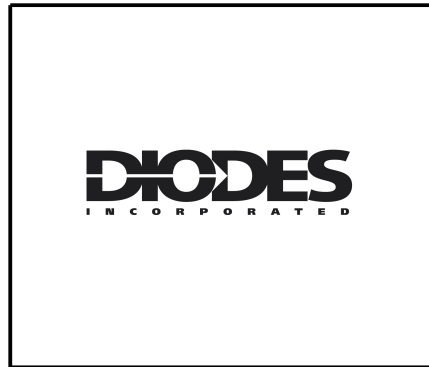

Side

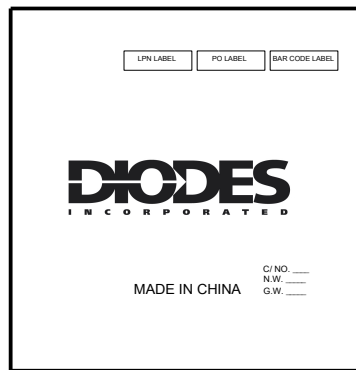

Front

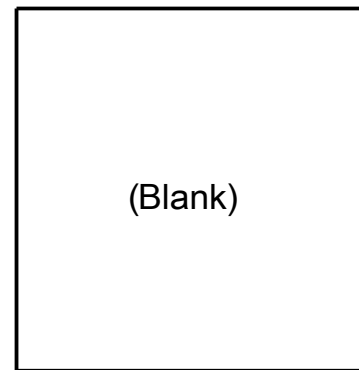

(Blank)

Back

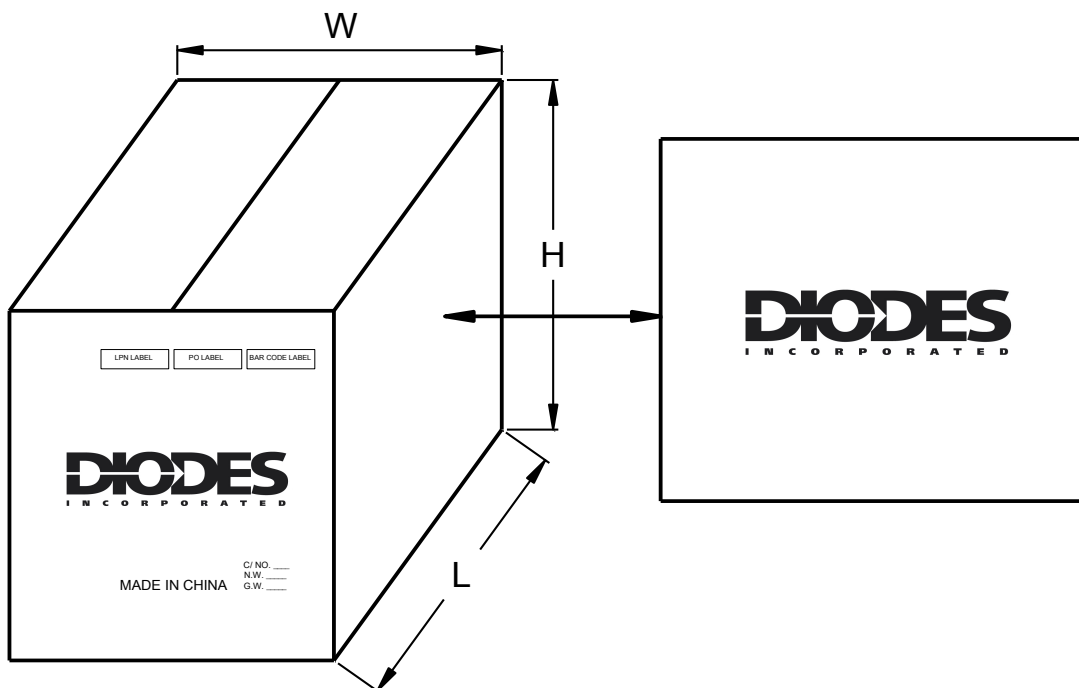

OUTER CARTON – TYPE B

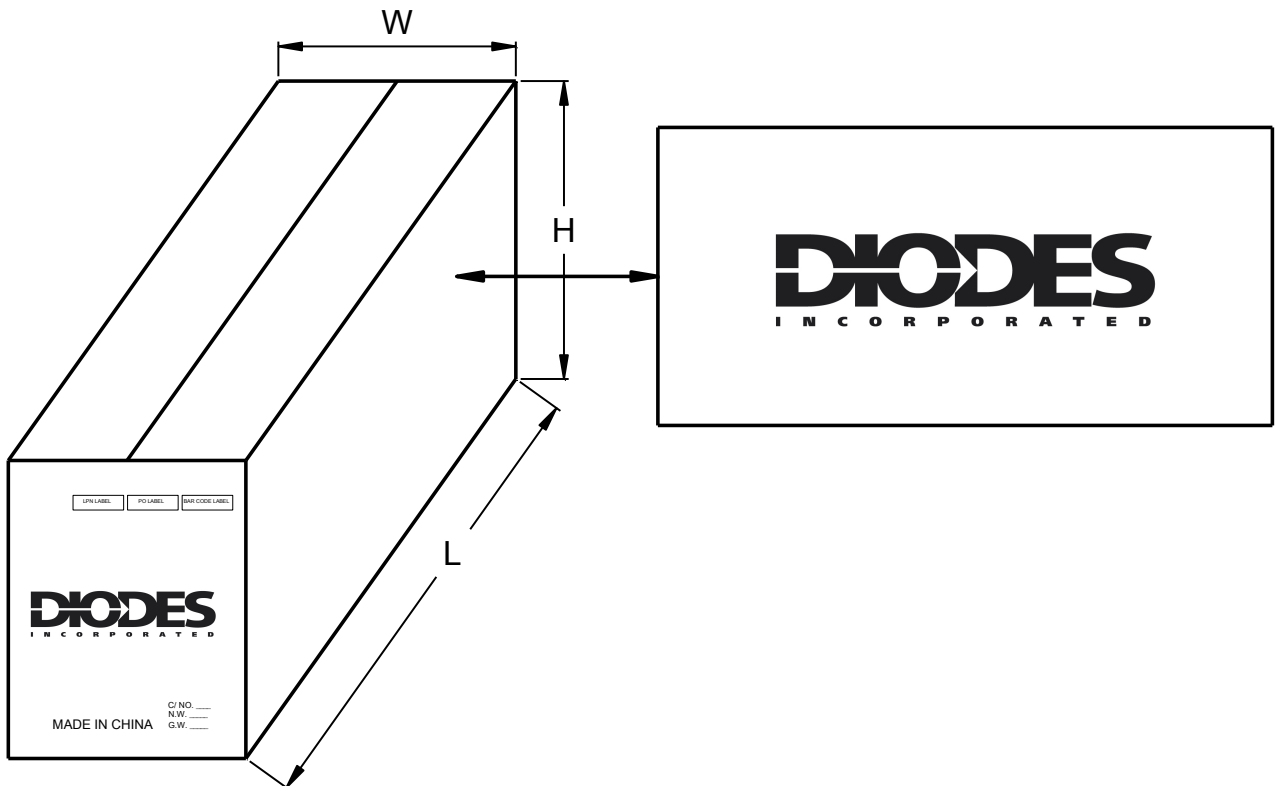
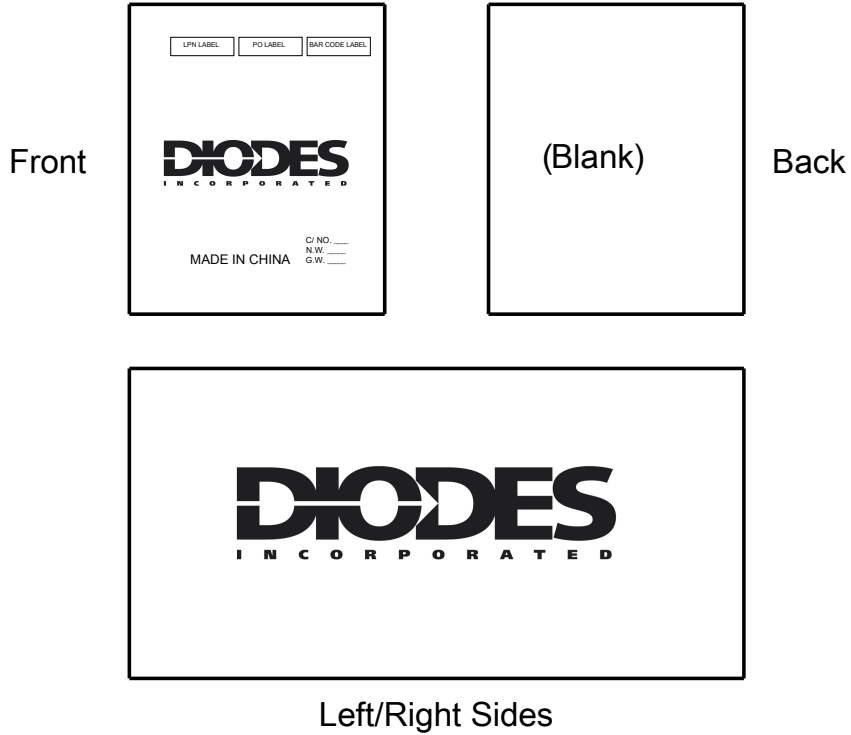

(Discrete Products)
SQUARE FRONT – Fig. 1

LPN LABEL

PO LABEL

BAR CODE LABEL

DIODES
I N C O R P O R A T E D

MADE IN CHINA

C/ NO. ____

N.W. ____

G.W. ____

(Discrete Products)
SQUARE SIDE – Fig. 2



(Discrete Products)
RECTANGLE (FRONT SIDE) – Fig. 3

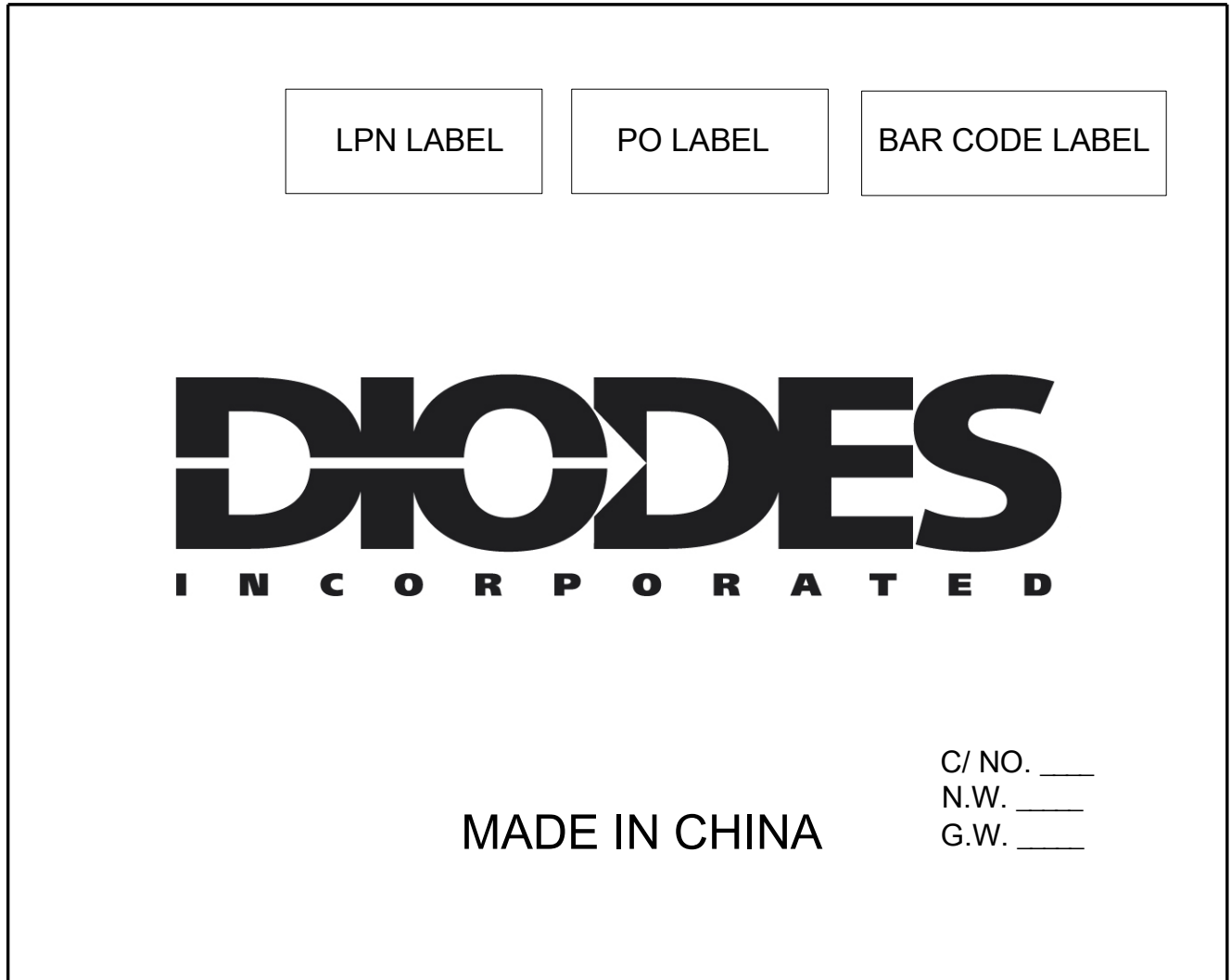

(Discrete Products)
RECTANGLE (LONG SIDE) – Fig. 4



(Discrete Products)
OUTER CARTON SPECIFICATIONS

PRODUCT PACKAGING	HEIGHT (H)		WIDTH (W)		LENGTH (L)		CARTON TYPE
	Inches	mm	inches	mm	inches	mm	
7" Tape	9.37	238	16.9	430	17.00	432	Fig. 5
13" Tape	12.12	308	13.11	333	13.22	336	Fig. 6
13" Tape (TC option)	14.88	378	13.94	354	17.32	440	A
POWERDI [®] 5SP	13.94	354	14.88	378	17.32	440	A
Tube	8.62	219	7.56	192	22.64	575	B

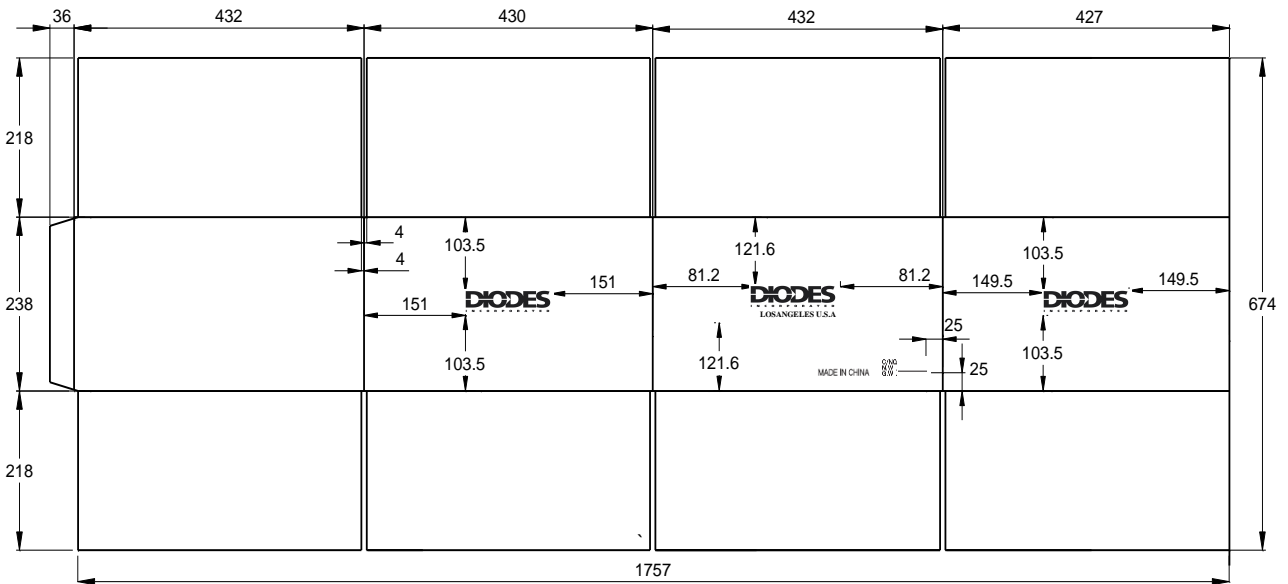

Fig. 5

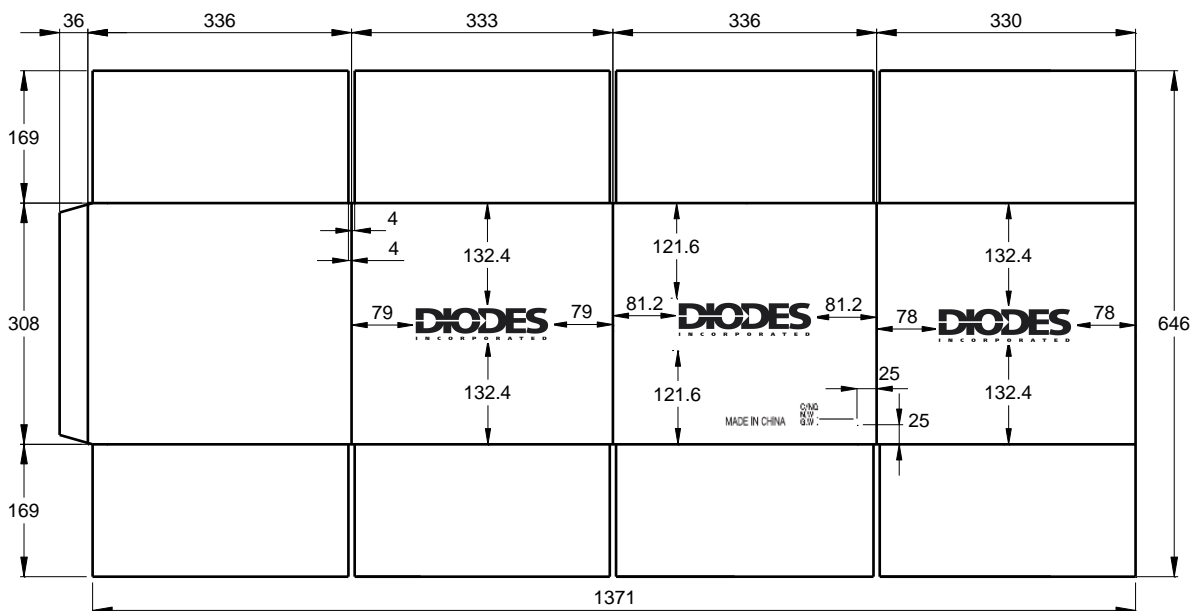

Fig. 6

(Discrete Products)
INNER CARTON SPECIFICATIONS

PRODUCT PACKAGE (7" Tape)		INNER CARTON						QTY	CARTON TYPE	
		HEIGHT (H)		WIDTH (W)		LENGTH (L)				
		inches	mm	inches	mm	inches	mm			
DFN Series (3K/reel)		8.11	206	7.87	200	8.00	203	45000	Fig. 7	
DFN Series (10K/reel)								150000		
POWERDI®123 / POWERDI®323								45000		
POWERDI®3333								24000		
SC59								45000		
SOD123/323/523								45000		
SOD323F								45000		
SOT23/323/353/363/523/666								45000		
SOT25/26/SC-74R								45000		
SOT553/563								45000		
SOT953/963								150000		
DFN Series		Note 1	0.59	15	7.28	185	7.28	185	3000	Fig. 8
SOD323 / 523										
SOT23F										
SOT23/ 323/ 25/ 26										
MSOP-8		Note 1	0.79	20	7.28	185	7.28	185	1000	
SM-8									500	
SO-8									1000	
SOT223										
SOT89										

Note: 1. Applies to TA or TD taping suffix.

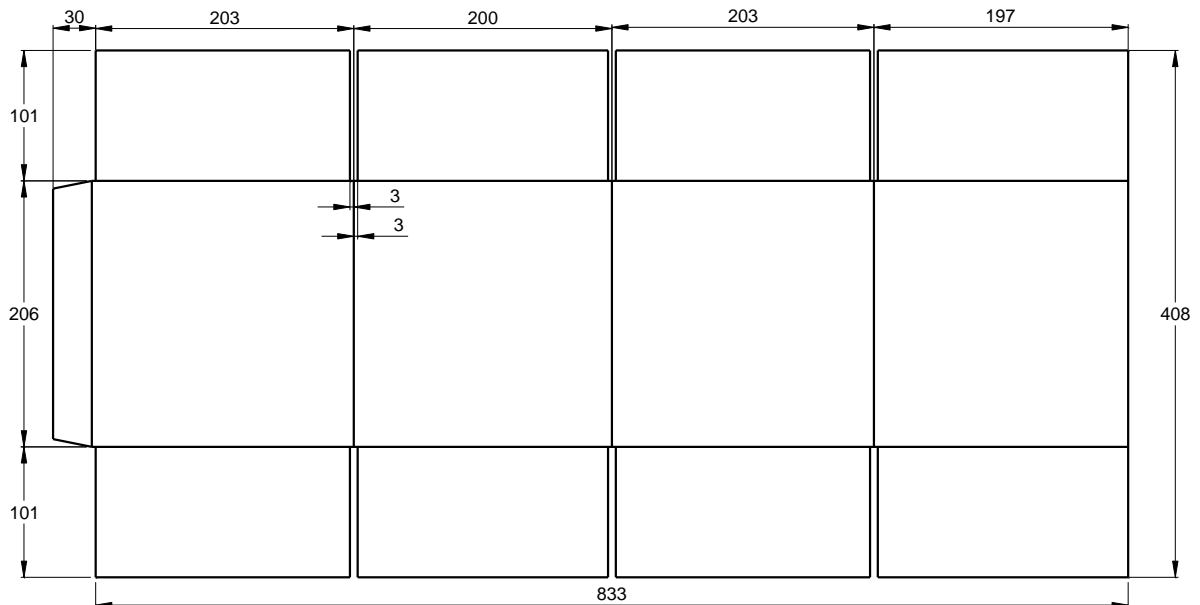

Fig. 7

(Discrete Products)
INNER CARTON SPECIFICATIONS

PRODUCT PACKAGE (13" Tape)	INNER CARTON						QTY	CARTON TYPE
	HEIGHT (H)		WIDTH (W)		LENGTH (L)			
	inches	mm	inches	mm	inches	mm		
DFN Series	0.79	20	13.58	345	13.58	345	10000	Fig. 8
MSOP-8 / SO-8 / PowerDI5060							2500	
SOD323 / 523							10000	
SOT23/ 23F/ 323/ 26							10000	
SOT223							4000	
SOT89	4000							
POWERDI [®] 5SP	1.97	50	13.35	339	13.90	353	3500	
TO252	1.18	30	13.58	345	13.58	345	2500	

Note 2. Discrete packages in 13" reel other than those mentioned above are boxed directly to the specified outer carton.

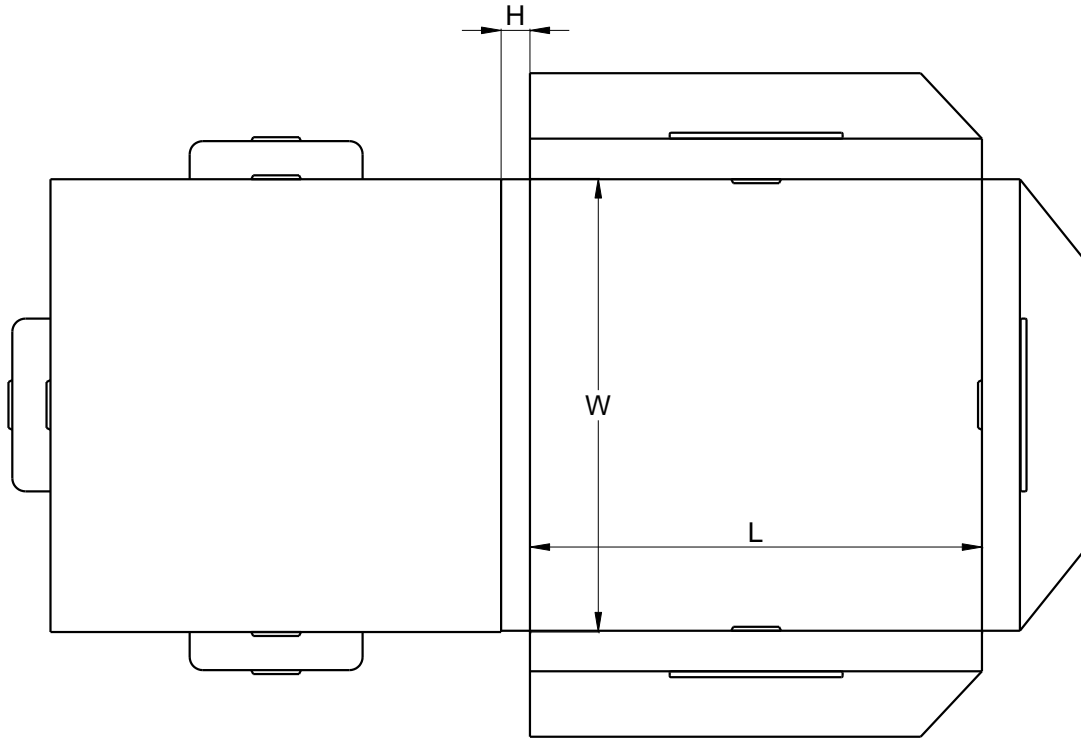

Fig. 8

PRODUCT PACKAGE (Tube)	INNER CARTON						QTY	CARTON TYPE
	HEIGHT (H)		WIDTH (W)		LENGTH (L)			
	inches	mm	inches	mm	inches	mm		
TO263 TO220, ITO220, TO262	3.74	95	6.77	172	21.85	555	2000	-

PRODUCT PACKAGE (Ammo Packing)	Note 3	INNER CARTON						QTY	CARTON TYPE
		HEIGHT (H)		WIDTH (W)		LENGTH (L)			
		inches	mm	inches	mm	inches	mm		
TO92	Note 3	1.69	43	6.38	162	13.11	333	2000	-

Note: 3. Discrete packages with STZ taping suffix. Refer to datasheet for details.

**(Analog IC Products)
OUTER CARTON SPECIFICATIONS**

PRODUCT PACKAGING	OUTER CARTON						CARTON TYPE	
	HEIGHT (H)		WIDTH (W)		LENGTH (L)			
	Inches	mm	inches	mm	inches	mm		
Tube, Tray, Bag, PVC Box	8.58	218	15.55	395	25.08	637	Fig 9	
Tube (DIP 14L)	6.50	165	15.20	386	22.63	575	B	
7" & 13" Tape, Ammo Box	15.34	390	13.97	358	17.32	446	Fig.10	
7" & 13" Tape, Pizza Box/Inner Box	Note 4	15.34	390	13.97	358	17.32	446	Fig. 10

Note: 4. Applies to small scale shipment (i.e. Max 4 pizza boxes or 6 inner boxes).

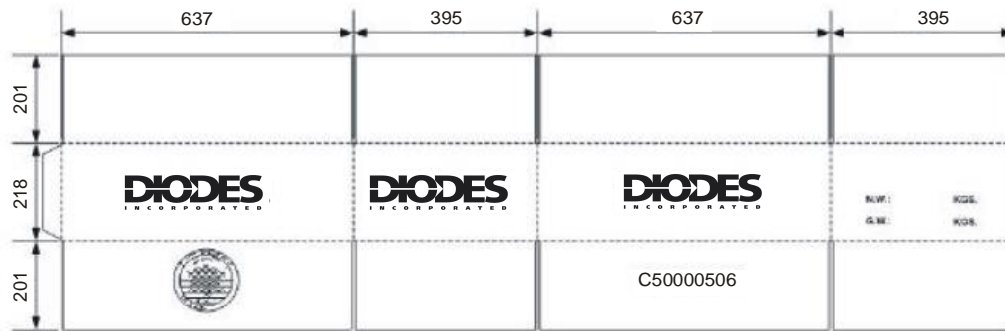

Fig. 9

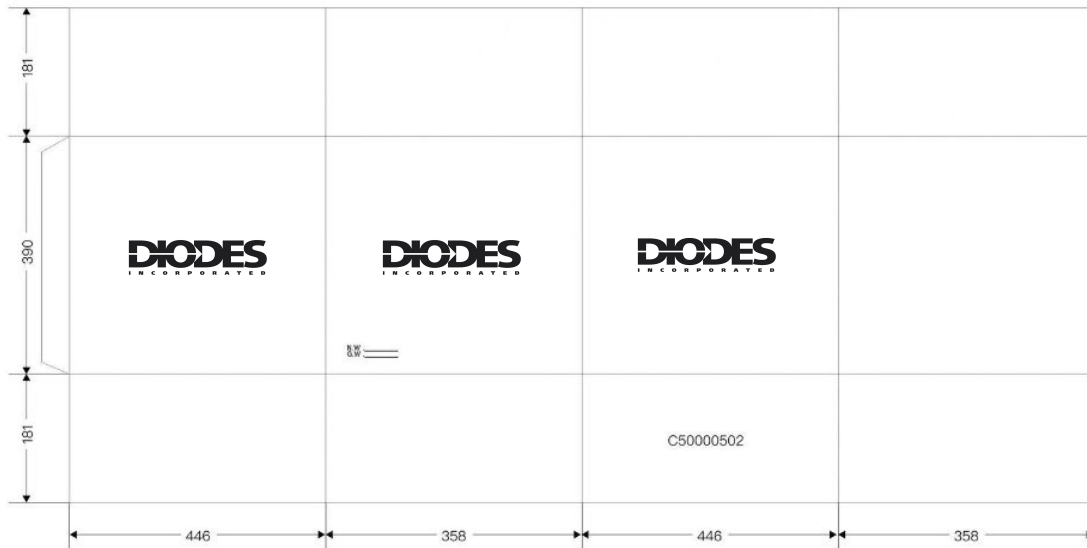

Fig. 10

(Analog IC Products)
INNER CARTON SPECIFICATIONS

PRODUCT PACKAGE (13" Tape)	INNER CARTON						Qty	Carton Type
	HEIGHT (H)		WIDTH (W)		LENGTH (L)			
	inches	mm	inches	mm	inches	mm		
MSOP SOT223 SOT89	1.97	50	13.35	339	13.90	353	2500	Fig. 11
PLCC(20-Lead)	1.97	50	13.35	339	13.90	353	1,000	Fig. 11
PLCC(28-Lead)	6.00	152	6.50	165	19.50	495	750	
PLCC(44-Lead)	1.13	29	13.25	337	13.25	337	500	
TO263	1.97	50	13.35	339	13.90	353	800	Fig. 11
TSSOP(8,16-Lead)	0.90	23	3.38	86	7.88	200	2,500	
SOP (300mil)	1.50	3	3.00	76	12.00	305	1,000	
TSSOP (20,24,28-Lead)	1.50	38	13.50	343	13.38	340	2,000	
POWERDI [®] 5	7.36	187	8.00	203	20.00	508	5,000	

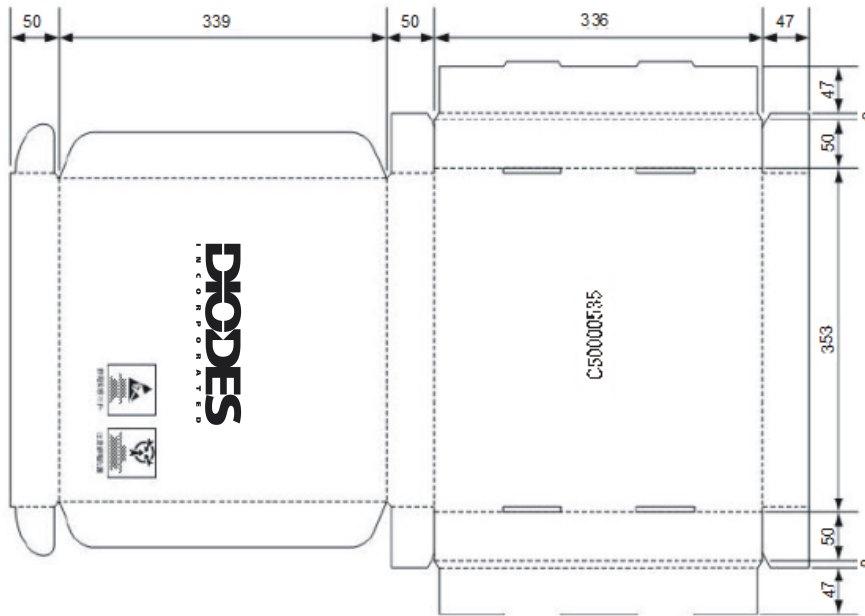

Fig. 11

(Analog IC Products)
INNER CARTON SPECIFICATIONS

PRODUCT PACKAGE (Ammo Box)	HEIGHT (H)		WIDTH (W)		LENGTH (L)		Qty (Fig. 12)
	inches	mm	inches	mm	inches	mm	
SIP	1.57	40	7.68	195	12.99	330	4,000
TO-92							2,000

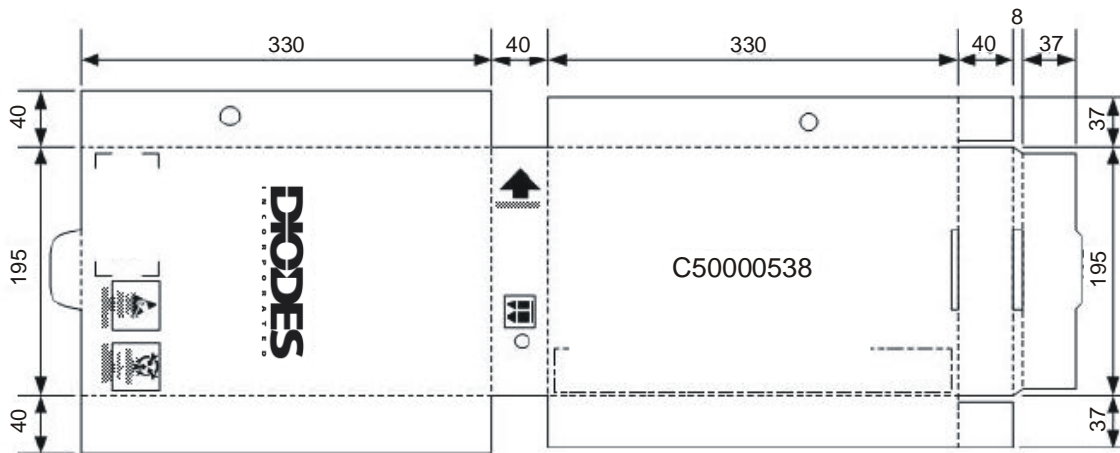

Fig. 12

(Analog IC Products)
INNER CARTON SPECIFICATIONS

PRODUCT PACKAGE (Tube)	HEIGHT (H)		WIDTH (W)		LENGTH (L)		Qty (Fig. 13)
	inches	mm	inches	mm	inches	mm	
DIP(300mil)(8-Lead)	3.82	97	7.36	187	24.61	625	5040
DIP(300mil)(14-Lead) Note 6	2.76	70	5.31	135	21.81	554	1000
DIP(300mil)(16-Lead)							2520
DIP(300mil)(20-Lead)							1260
DIP(300mil)(24-Lead)							1050
DIP(300mil)(28-Lead)							980
DIP(600mil)(40-Lead)							360
PLCC(20-Lead)							4800
PLCC(28-Lead)							3800
PLCC(44-Lead)							2080
SIP(Dry Pack),TO-92							20000
SIP(PVC Box)							25000
SOP(150mil)(5,7,8-Lead)							44000
SOP(150mil)(14-Lead)							24640
SOP(150mil)(16-Lead)	3.82	97	7.36	187	24.61	625	22000
SOP(300mil)(20-Lead)							5550
SOP(300mil)(24-Lead)							4650
SOP(300mil)(28-Lead)							3900
SOT-223							22500
TO220,TO263							2000
TO220R(5-Lead)							1000
TO252							9600
TSSOP(8-Lead)							67200
TSSOP(16-Lead)							40320
TSSOP(20-Lead)							30000
TSSOP(24-Lead)							24800
TSSOP(28-Lead)							20800

Note : 6. See Fig 15 for carton type.

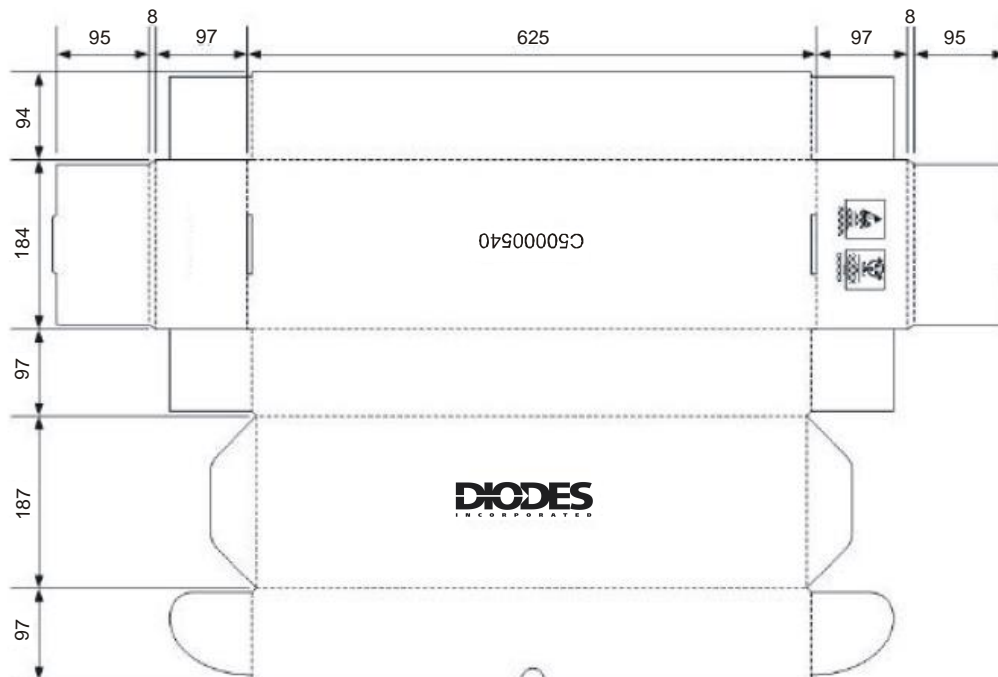

Fig. 13



Fig. 14

(Analog IC Products)
INNER CARTON SPECIFICATIONS

PRODUCT PACKAGE (Tray)	HEIGHT (H)		WIDTH (W)		LENGTH (L)		Qty (Fig. 15)
	inches	mm	inches	mm	inches	mm	
LQFP, TQFP	3.54	90	5.91	150	14.17	360	1,600
QFP(44-Lead)							960
QFP(52-Lead)							840

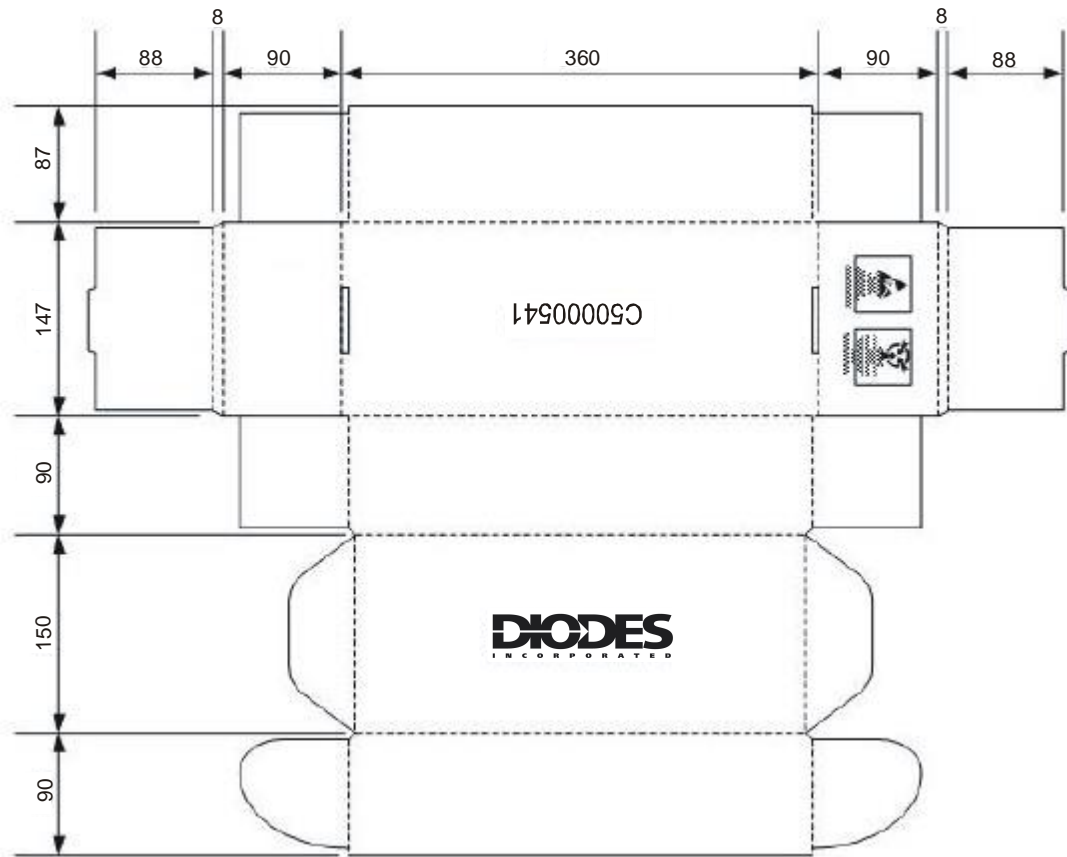

Fig. 15

(Analog IC Products)
INNER CARTON SPECIFICATIONS

PRODUCT PACKAGE (7" Tape)	HEIGHT (H)	WIDTH (W)	LENGTH (L)	Qty (Fig. 16)
	mm	mm	mm	
SOT23,SOT25, SC59 SOT323, SOT353	112	179	181	15,000
DFN/QFN Series (Note 7)				15,000
QFN4040				6,000

Note: 7. Applicable unless otherwise specified in the table.

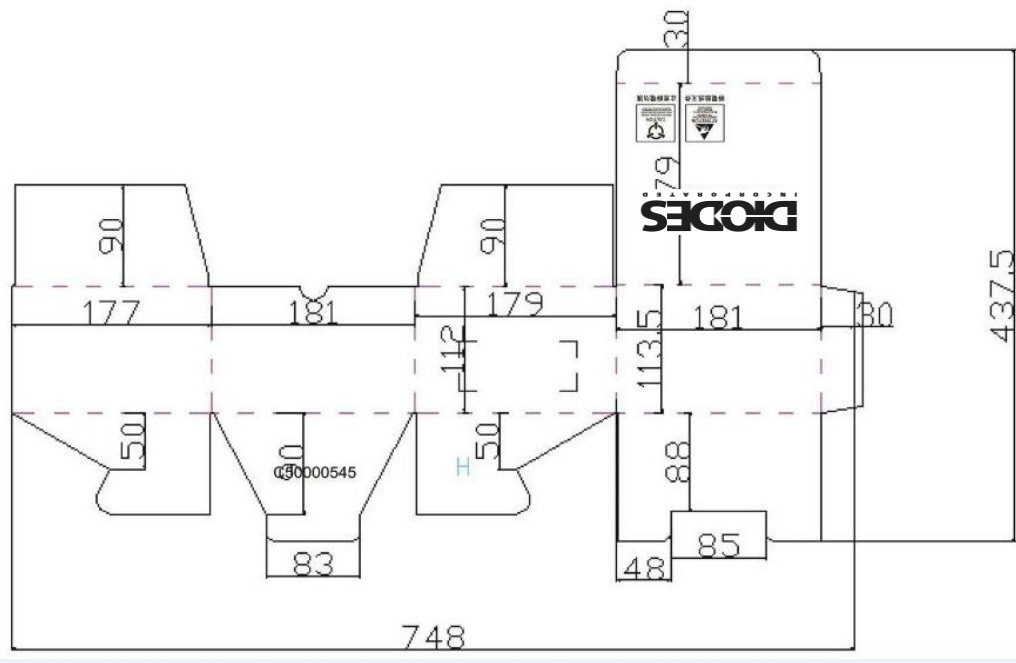

Fig. 16