

Description

Advanced process capability has been used to maximise the performance of this 60V, NPN transistor. The W-DFN2020-3/SWP (Type A) package offers lower profile and the derating up to +175°C allows higher dissipation for applications where power density is of utmost importance.

Features

- $BV_{CEO} > 60V$
- $I_C = 4A$ Continuous Collector Current
- Low Saturation Voltage (100mV Max @1A)
- $R_{SAT} = 60m\Omega$ for a Low Equivalent On-Resistance
- h_{FE} Specified up to 6A for High Current Gain Hold Up
- Tighter Gain Specification
- Low Profile 0.62mm High Package for Thin Applications
- Sidewall Tin Plating for Wettable Flanks in AOI
- $R_{\theta JA}$ Efficient, 60% Lower than SOT23
- 4mm² Footprint, 50% Smaller Than SOT23
- Rated +175°C – Ideal for High Temperature Environment
- **Totally Lead-Free & Fully RoHS Compliant (Notes 1 & 2)**
- **Halogen and Antimony Free. "Green" Device (Note 3)**
- **The DXTN10060DFJBWQ is suitable for automotive applications requiring specific change control and is AEC-Q101 qualified, is PPAP capable, and is manufactured in IATF16949:2016 certified facilities.**

Mechanical Data

- Case: W-DFN2020-3
- Nominal Package Height: 0.6mm
- Case Material: Molded Plastic. "Green" Molding Compound. UL Flammability Rating 94V-0
- Moisture Sensitivity: Level 1 per J-STD-020
- Terminals: Finish - Matte Tin, Solderable per MIL-STD-202, Method 208 ③
- Weight: 0.01 grams (Approximate)

Applications

- Automotive Systems
 - MOSFET Gate Driving
 - DC-DC Converters
 - Motor Control
 - Power Switches

W-DFN2020-3/SWP (Type A)

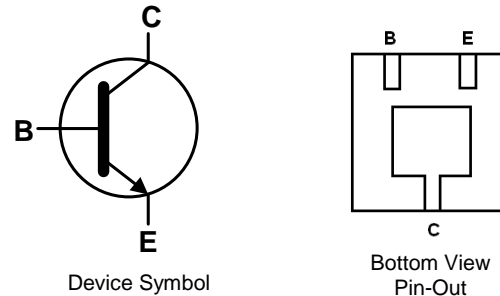
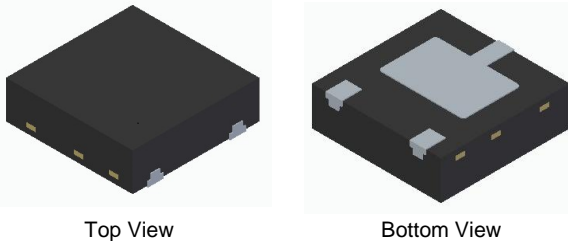

Ordering Information (Note 4)

Part Number	Compliance	Marking	Reel Size (inches)	Tape Width (mm)	Quantity Per Reel
DXTN10060DFJBWQ-7	Automotive	2L7	7	8	3,000

- Notes:
1. No purposely added lead. Fully EU Directive 2002/95/EC (RoHS), 2011/65/EU (RoHS 2) & 2015/863/EU (RoHS 3) compliant.
 2. See <https://www.diodes.com/quality/lead-free/> for more information about Diodes Incorporated's definitions of Halogen- and Antimony-free, "Green" and Lead-free.
 3. Halogen- and Antimony-free "Green" products are defined as those which contain <900ppm bromine, <900ppm chlorine (<1500ppm total Br + Cl) and <1000ppm antimony compounds.
 4. For packaging details, go to our website at <https://www.diodes.com/design/support/packaging/diodes-packaging/>.

Marking Information

W-DFN2020-3/SWP (Type A)

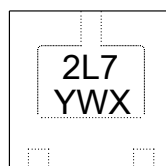

- 2L7 = Product Type Marking Code
- Y = Year: 0~9
- W = Week: A~Z: 1~26 Week; a~z: 27~52 Week; z Represents 52 and 53 Week
- X = A~Z: Internal Code

Absolute Maximum Ratings (@T_A = +25°C, unless otherwise specified.)

Characteristic	Symbol	Value	Unit	
Collector-Base Voltage	V _{CBO}	100	V	
Collector-Emitter Voltage	V _{CEO}	60		
Emitter-Base Voltage	V _{EBO}	8		
Peak Pulse Current	I _{CM}	6	A	
Continuous Collector Current	I _C	(Note 5)		4
		(Note 6)		4.3
Base Current	I _B	1		

Thermal Characteristics (@T_A = +25°C, unless otherwise specified.)

Characteristic	Symbol	Value	Unit
Power Dissipation	P _D	(Note 5)	1.8
			12
Linear Derating Factor		(Note 6)	2.94
			19.6
Thermal Resistance, Junction to Ambient	R _{θJA}	(Note 5)	83
		(Note 6)	51
Thermal Resistance, Junction to Lead	R _{θJL}	16.8	°C/W
Operating and Storage Temperature Range	T _J , T _{STG}	-55 to +175	°C

ESD Ratings (Note 8)

Characteristic	Symbol	Value	Unit	JEDEC Class
Electrostatic Discharge - Human Body Model	ESD HBM	4,000	V	3A
Electrostatic Discharge - Machine Model	ESD MM	400	V	C

- Notes:
5. For a device mounted with the exposed collector pad on 31mm x 31mm (10cm²) 1oz copper that is on a single sided 1.6mm FR-4 PCB; device is measured under still air conditions whilst operating in a steady-state. The entire exposed collector pad is attached to the heatsink.
 6. Same as Note 5, except the device is measured at t ≤ 5 sec.
 7. Thermal resistance from junction to solder-point (on the exposed collector pad).
 8. Refer to JEDEC specification JESD22-A114 and JESD22-A115.

Thermal Characteristics and Derating Information

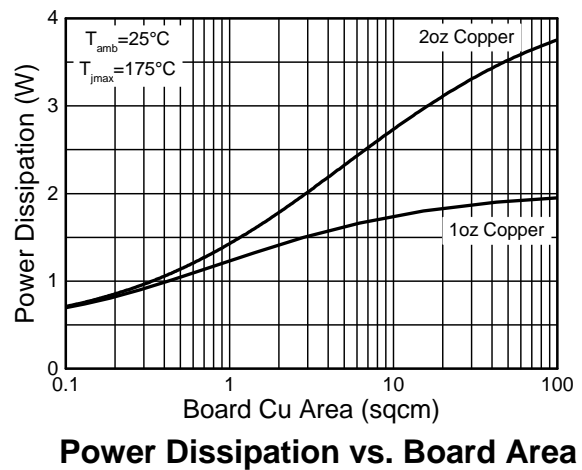
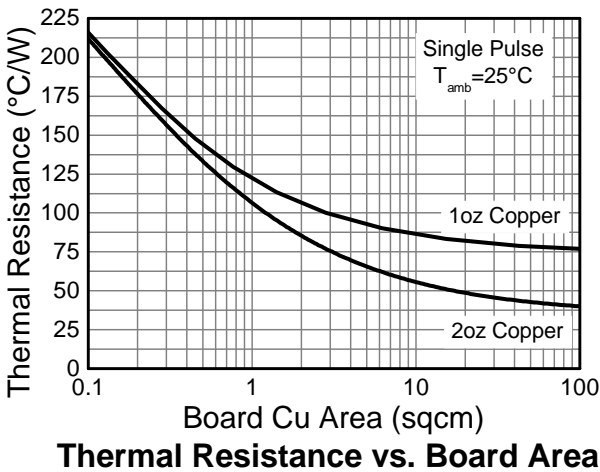
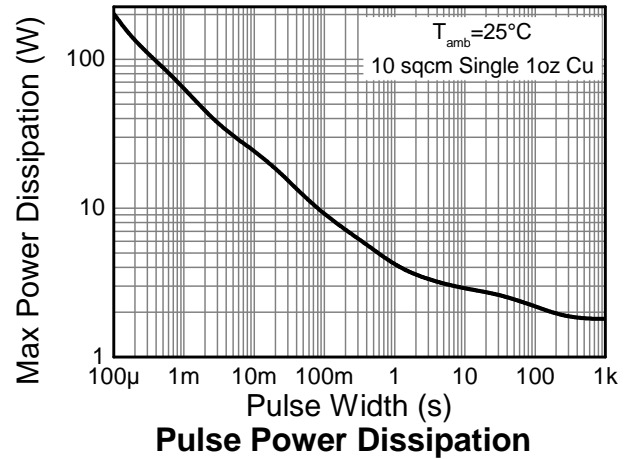
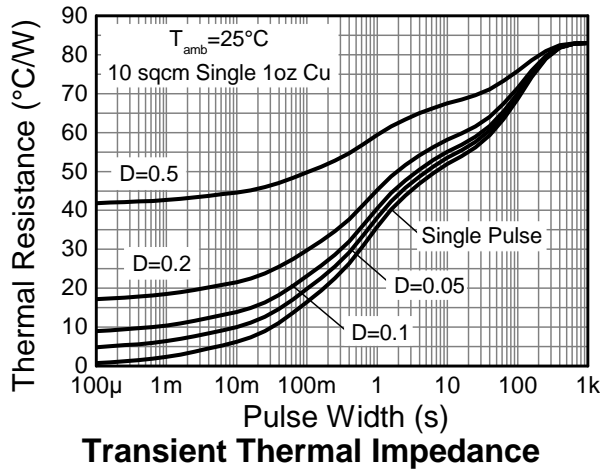
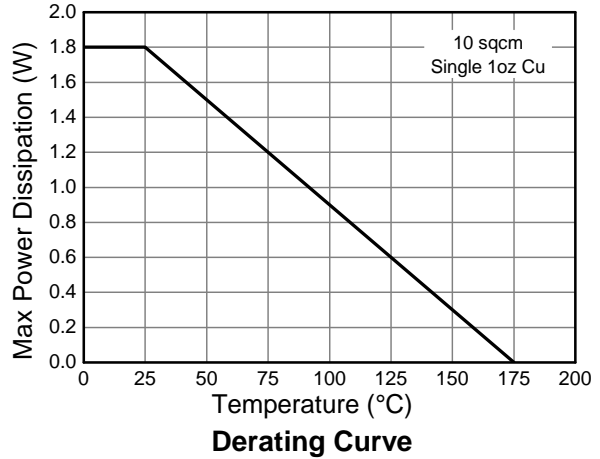
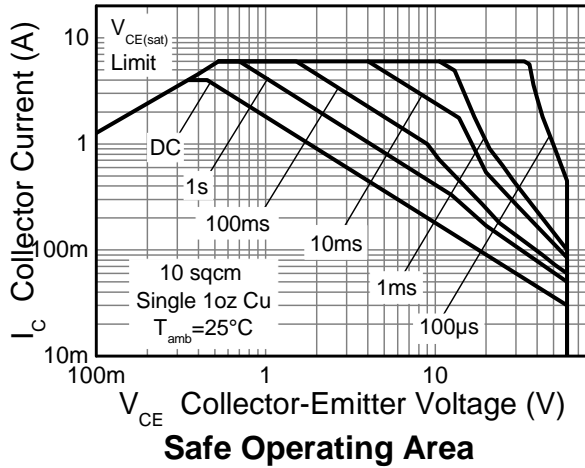

Electrical Characteristics (@T_A = +25°C, unless otherwise specified.)

Characteristic	Symbol	Min	Typ	Max	Unit	Test Condition
Collector-Base Breakdown Voltage	BV _{CBO}	150	187	-	V	I _C = 100μA
Collector-Emitter Breakdown Voltage (Note 9)	BV _{CEO}	60	66	-	V	I _C = 10mA
Emitter-Base Breakdown Voltage	BV _{EBO}	8	9	-	V	I _E = 100μA
Collector Cutoff Current	I _{CBO}	-	2	100	nA	V _{CB} = 120V
Emitter Cutoff Current	I _{EBO}	-	2	100	nA	V _{EB} = 7V
Collector Emitter Cutoff Current	I _{CES}	-	2	100	nA	V _{CES} = 48V
Static Forward Current Transfer Ratio (Note 9)	h _{FE}	250	444	550	-	I _C = 10mA, V _{CE} = 2V
		340	425	500		I _C = 200mA, V _{CE} = 2V
		250	363	--		I _C = 1A, V _{CE} = 2V
		140	205	--		I _C = 2A, V _{CE} = 2V
		20	40	--		I _C = 6A, V _{CE} = 2V
Collector-Emitter Saturation Voltage (Note 9)	V _{CE(SAT)}	--	12	20	mV	I _C = 0.1A, I _B = 10mA
		--	70	100		I _C = 1A, I _B = 50mA
		--	125	160		I _C = 1A, I _B = 10mA
		--	150	200		I _C = 2A, I _B = 50mA
		--	200	300		I _C = 3A, I _B = 100mA
		--	240	320		I _C = 4A, I _B = 200mA
Base-Emitter Turn-On Voltage (Note 9)	V _{BE(ON)}	--	0.94	1.00	V	I _C = 4A, V _{CE} = 2V
Base-Emitter Saturation Voltage (Note 9)	V _{BE(SAT)}	--	1.00	1.07	V	I _C = 4A, I _B = 200mA
Output Capacitance	C _{obo}	--	14	--	pF	V _{CB} = 10V, f = 1MHz
Transition Frequency	f _T	125	--	--	MHz	V _{CE} = 10V, I _C = 50mA, f = 100MHz
Turn-On Time	t _{ON}	--	200	--	ns	V _{CC} = 10V, I _C = 1A
Turn-Off Time	t _{OFF}	--	700	--	ns	I _{B1} = -I _{B2} = 10mA

Note: 9. Measured under pulsed conditions. Pulse width ≤ 300μs. Duty cycle ≤ 2%.

Typical Electrical Characteristics (@T_A = +25°C, unless otherwise specified.)

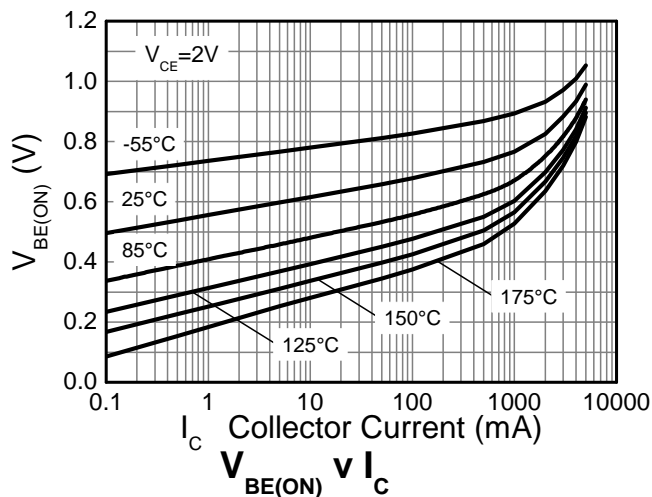
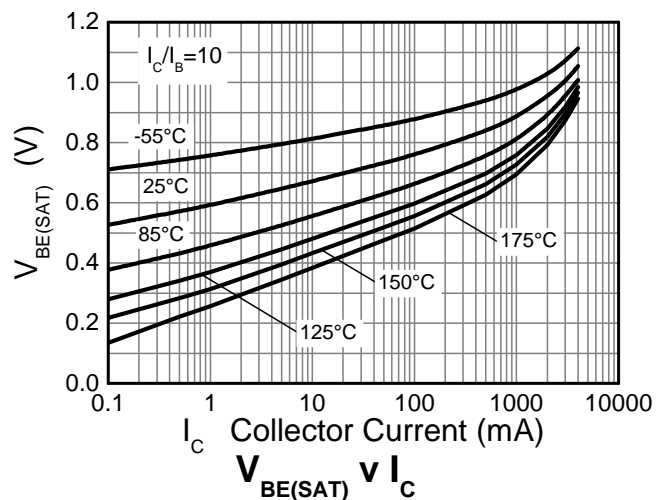
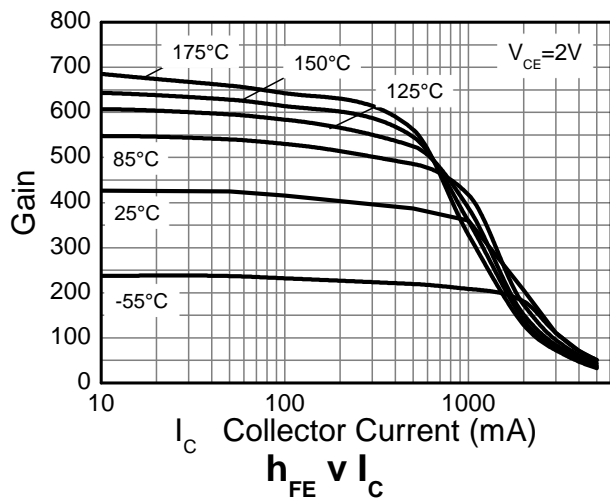
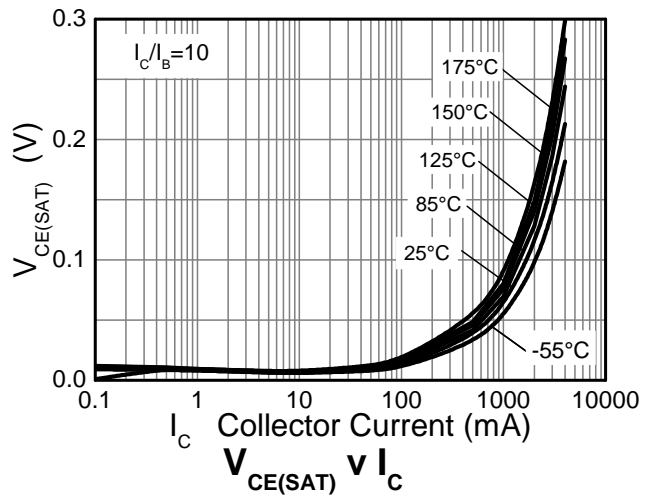
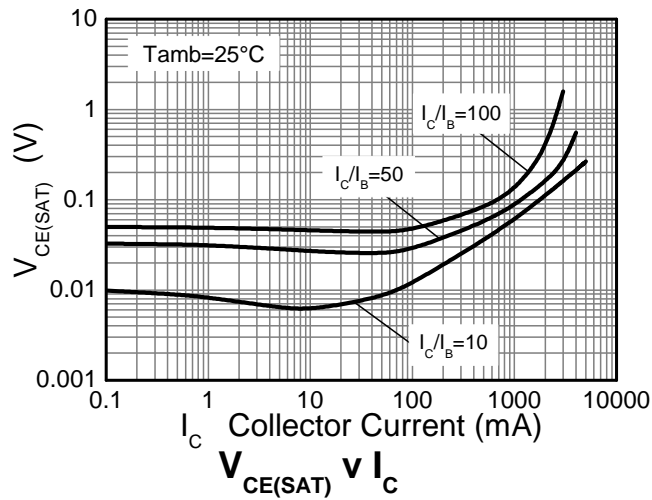

Package Outline Dimensions

Please see <http://www.diodes.com/package-outlines.html> for the latest version.

W-DFN2020-3/SWP (Type A)

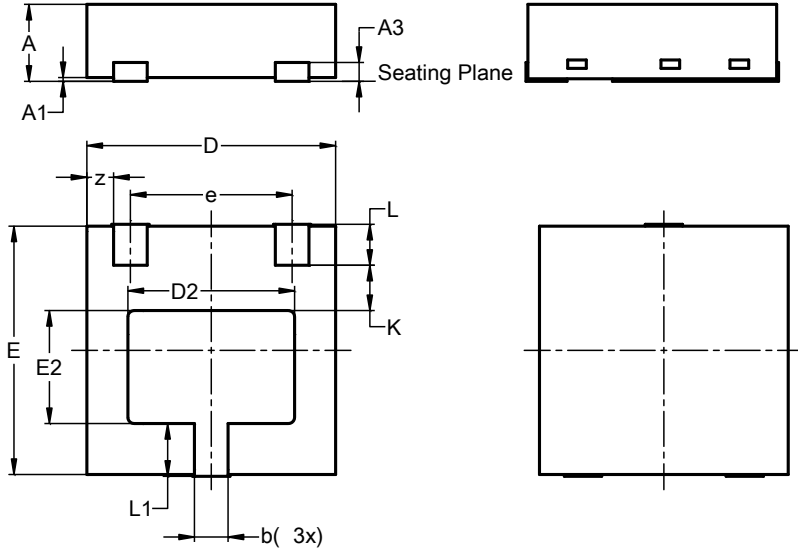

W-DFN2020-3 /SWP (Type A)			
Dim	Min	Max	Typ
A	0.57	0.67	0.62
A1	0.00	0.05	0.03
A3	—	—	0.152
b	0.22	0.32	0.27
D	1.95	2.05	2.00
D2	1.24	1.44	1.34
D4	0.56	0.76	0.66
E	1.95	2.05	2.00
E2	0.81	1.01	0.91
e	—	—	1.30
k	—	—	0.365
L	0.28	0.38	0.33
L1	0.375	0.475	0.425
z	—	—	0.215
All Dimensions in mm			

Suggested Pad Layout

Please see <http://www.diodes.com/package-outlines.html> for the latest version.

W-DFN2020-3/SWP (Type A)

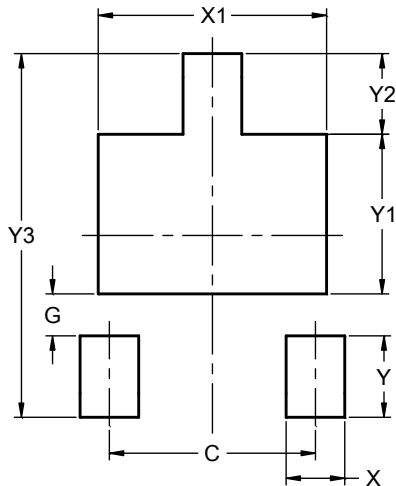

Dimensions	Value (in mm)
C	1.300
G	0.265
X	0.370
X1	1.440
Y	0.515
Y1	1.010
Y2	0.510
Y3	2.300

IMPORTANT NOTICE

DIODES INCORPORATED MAKES NO WARRANTY OF ANY KIND, EXPRESS OR IMPLIED, WITH REGARDS TO THIS DOCUMENT, INCLUDING, BUT NOT LIMITED TO, THE IMPLIED WARRANTIES OF MERCHANTABILITY AND FITNESS FOR A PARTICULAR PURPOSE (AND THEIR EQUIVALENTS UNDER THE LAWS OF ANY JURISDICTION).

Diodes Incorporated and its subsidiaries reserve the right to make modifications, enhancements, improvements, corrections or other changes without further notice to this document and any product described herein. Diodes Incorporated does not assume any liability arising out of the application or use of this document or any product described herein; neither does Diodes Incorporated convey any license under its patent or trademark rights, nor the rights of others. Any Customer or user of this document or products described herein in such applications shall assume all risks of such use and will agree to hold Diodes Incorporated and all the companies whose products are represented on Diodes Incorporated website, harmless against all damages.

Diodes Incorporated does not warrant or accept any liability whatsoever in respect of any products purchased through unauthorized sales channel. Should Customers purchase or use Diodes Incorporated products for any unintended or unauthorized application, Customers shall indemnify and hold Diodes Incorporated and its representatives harmless against all claims, damages, expenses, and attorney fees arising out of, directly or indirectly, any claim of personal injury or death associated with such unintended or unauthorized application.

Products described herein may be covered by one or more United States, international or foreign patents pending. Product names and markings noted herein may also be covered by one or more United States, international or foreign trademarks.

This document is written in English but may be translated into multiple languages for reference. Only the English version of this document is the final and determinative format released by Diodes Incorporated.

LIFE SUPPORT

Diodes Incorporated products are specifically not authorized for use as critical components in life support devices or systems without the express written approval of the Chief Executive Officer of Diodes Incorporated. As used herein:

A. Life support devices or systems are devices or systems which:

1. are intended to implant into the body, or
2. support or sustain life and whose failure to perform when properly used in accordance with instructions for use provided in the labeling can be reasonably expected to result in significant injury to the user.

B. A critical component is any component in a life support device or system whose failure to perform can be reasonably expected to cause the failure of the life support device or to affect its safety or effectiveness.

Customers represent that they have all necessary expertise in the safety and regulatory ramifications of their life support devices or systems, and acknowledge and agree that they are solely responsible for all legal, regulatory and safety-related requirements concerning their products and any use of Diodes Incorporated products in such safety-critical, life support devices or systems, notwithstanding any devices- or systems-related information or support that may be provided by Diodes Incorporated. Further, Customers must fully indemnify Diodes Incorporated and its representatives against any damages arising out of the use of Diodes Incorporated products in such safety-critical, life support devices or systems.

Copyright © 2019, Diodes Incorporated

www.diodes.com