

General Description

This development kit features a universal control board and an AL58263 or AL58263Q driver board, both powered via USB Type-C.

The universal board is equipped with an automotive grade 32-bit Arm M0 core MCU and integrates LIN, CAN, and UART communication interfaces to provide display data to the AL58263/Q driver board. The AL58263/Q board includes 16 RGB LEDs, controlled by three integrated AL58263/Q ICs, enabling precise control of lighting effects.

This kit supports daisy chaining of up to two driver boards, making it ideal for automotive applications such as instrument clusters, lighting, and other LED-based displays in both automotive and commercial environments.

Features

- AEC-Q100 Grade1 Qualified
- Input Voltage VDD: 3V to 5.5V
- Output Current Range
 - 2~55mA/5V, 2~35mA/3.3V
 - $\pm 0.1\%$ output current regulation capability
 - 6-bit global current control: from 12.5% to 200%
- 16 Constant-Current Sink Output Channel
 - 16-bit grayscale resolution with Adaptive Pulse
 - Density Modulation (APDM) control
 - 15V-rated output channels for long LED strings
 - Fast Transient Response—supports external grayscale clocks with double edge up to 16MHz
 - $\pm 1.5\%$ (typical) LED current accuracy between channels
 - $\pm 3\%$ (typical) LED current accuracy between chips
 - Non-scramble waveform for high-power LED applications
 - Grayscale counter reset selection
 - Grayscale data synchronization selection
- Diagnostics and Protections
 - Error detection includes LED open, LED short, output port leakage, output short-to-GND, output short-to-power, and REXT short-to-GND
 - Error detection LEDs at 0.1mA to avoid flickering
 - Short detection threshold voltage selection (2/3/4/4.5V)
 - Sleep and 0-data mode to lower down the supply current
 - Pre-ovtemperature warning
- 4-Wire Serial Interface (LAT, DI, DO, DCK)
 - 25MHz clock frequency for data transfer
 - EMI reduction grayscale clock
 - Cascaded capability (max 1,440 devices)
 - External GCK watchdog
 - Stagger outputs delay for EMI reduction
- **Totally Lead-Free & Fully RoHS Compliant (Notes 1 & 2)**
- **Halogen and Antimony Free. “Green” Device (Note 3)**
- **The AL58263Q is suitable for automotive applications requiring specific change control; this part is AEC-Q100 qualified, PPAP capable, and manufactured in IATF16949 certified facilities.**

<https://www.diodes.com/quality/product-definitions/>

- Notes: 1. No purposely added lead. Fully EU Directive 2002/95/EC (RoHS), 2011/65/EU (RoHS 2) & 2015/863/EU (RoHS 3) compliant.
 2. See <https://www.diodes.com/quality/lead-free/> for more information about Diodes Incorporated’s definitions of Halogen- and Antimony-free, “Green” and Lead-free.
 3. Halogen- and Antimony-free “Green” products are defined as those which contain <900ppm bromine, <900ppm chlorine (<1500ppm total Br + Cl) and <1000ppm antimony compounds.

Applications

AL58263:

- Indoor and outdoor LED video displays
- Variable message signs (VMS)
- Traffic signs
- Outdoor billboard signage
- LCD display backlighting

AL58263Q:

- Automotive clusters
- Automotive local dimming displays
- Automotive front and back faceplates
- Automotive center stack displays
- Automotive interior and RGB lighting
- Automotive HVAC control panels
- Automotive gear shifter indicators
- Automotive exterior lightings

Specifications

Parameter	Value
Input Voltage	USB-C
Output Current	6.725mA
Output Voltage	5V
Dimension	95mm*14mm*13mm
RoHS Compliance	Yes

Evaluation Board

Figure 1: AL58263EV2 Top View

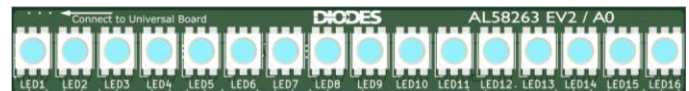

Figure 2: AL58263EV2 Bottom View

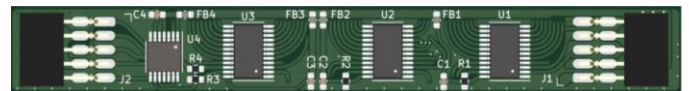

Figure 3: AL58263QEV2 Top View

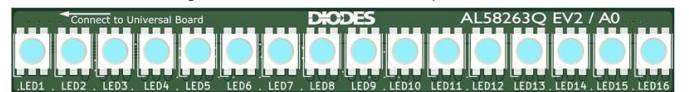
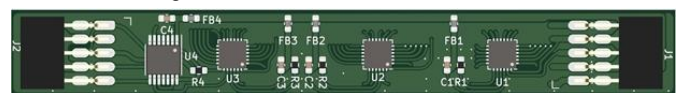

Figure 4: AL58263QEV2 Bottom View



Connection Instructions

- DC Input: USB-C

General Description

This development kit offers a comprehensive solution for RGB lighting control, and features a universal control board and an AL58263 or AL58263Q driver board, both powered via USB-C. The universal board uses an automotive-grade 32-bit Arm M0 core, designed for reliable performance in automotive environments. It integrates LIN, CAN, and UART communication interfaces to enable seamless interaction with external systems and deliver precise control data to the AL58263/Q driver board.

The AL58263 and AL58263Q driver boards are equipped with 16 integrated RGB LEDs on the front, controlled by three AL58263/Q ICs on the back. These ICs are optimized for driving high-brightness RGB LEDs with fine control over color mixing, brightness, and efficiency. They allow smooth color transitions and dimming, making them ideal for applications that demand dynamic and accurate lighting control. The kit supports daisy chaining of up to two AL58263/Q driver boards, enabling greater scalability in lighting setups.

The kit is particularly suited for a range of automotive applications such as:

- Automotive Clusters: Bright, colorful displays for dashboards.
- Automotive Local Dimming Displays: Adaptive lighting for different environments.
- Automotive Front and Back Faceplates: Customizable interior and exterior lighting.
- Automotive Center Stack Displays: Interactive display panels within vehicles.
- Automotive RGB Lighting: Atmospheric RGB lighting for interiors.
- Automotive HVAC Control Panels: Visual feedback for HVAC systems.
- Automotive Gear Shifter Indicators: Clear, dynamic lighting for gear selection.
- Automotive Exterior Lighting: RGB-controlled headlights, taillights, and signals.

Beyond automotive uses, the development kit is ideal for commercial LED displays such as:

- Indoor and Outdoor LED Video Displays: High-brightness, rich color displays.
- Variable Message Signs (VMS): Dynamic public messaging systems.
- Traffic Signs: High visibility displays for road safety.
- Outdoor Billboard Signage: Vibrant, reliable outdoor advertisements.
- LCD Display Backlighting: Enhanced brightness and color for large screens.

The inclusion of USB Type-C power simplifies the development process, ensuring a modern and reliable power interface. This kit provides developers with the tools needed to build high-performance RGB lighting systems for both automotive and commercial applications, offering flexibility, scalability, and precision. With durable automotive-grade components, the kit ensures reliability across a wide range of use cases, making it ideal for projects requiring dynamic and accurate RGB lighting control.

Hardware Description

The evaluation kit, as shown in Figure 5 and Table 1, includes a universal board and an AL58263Q evaluation board. The universal board is a control board equipped with an MCU and two DIP switches. Users can connect to the Nuvoton programmer via section 6 in Figure 5 for firmware updates, and the DIP switches can be used for functional testing. The AL58263 and AL58263Q evaluation boards connect to the universal board through section 11 for demonstration purposes, with a default configuration supporting up to two daisy-chained connections.

Figure 5. Evaluation Kit Top View

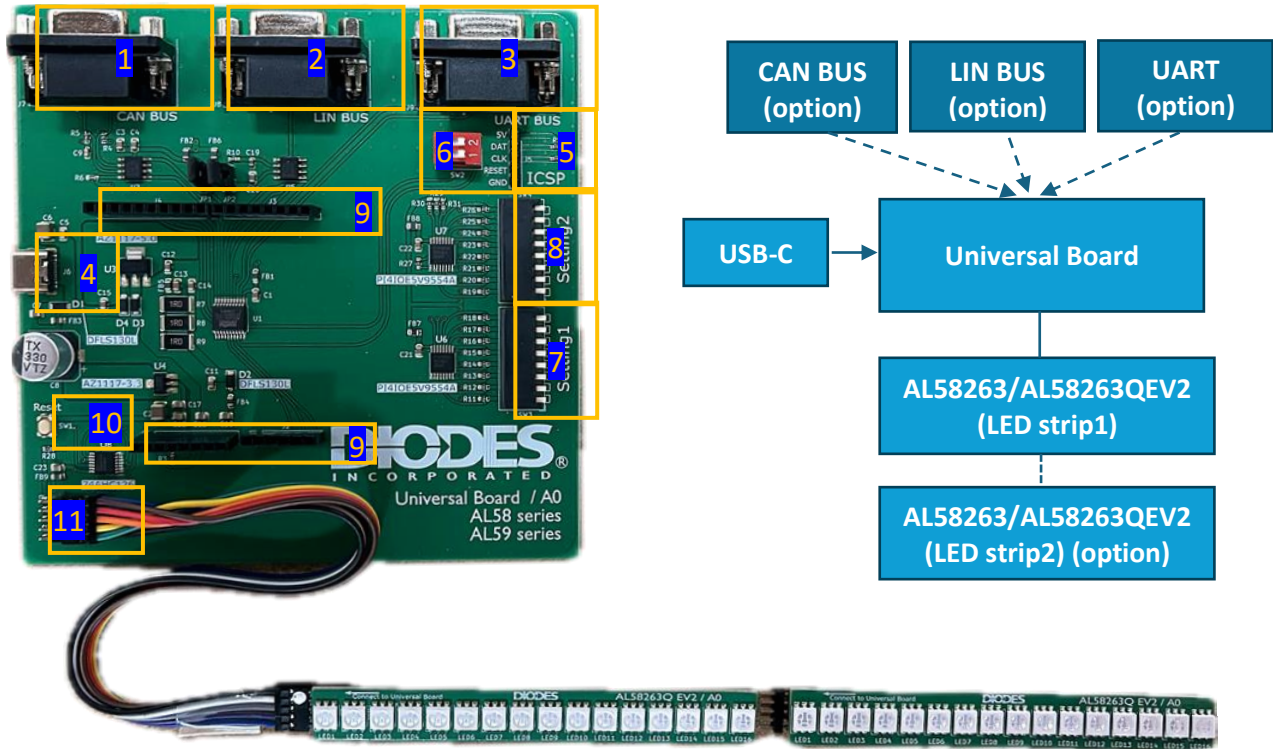

Table 1: EVB Section Description

Section	Description
1	CAN Bus communication interface female connector
2	LIN Bus communication interface female connector
3	UART communication interface female connector
4	USB-C DC_IN female connector
5	MCU online debug/program connector
6	MCU program data connect to test pin switch
7	Demo display animations selection
8	Function selection
9	Test pin
10	System Reset button
11	AL58263/Q connecting socket

Quick Start Guide

Please connect the universal board with the AL58263 or AL58263Q development board, and then connect the USB Type-C cable between the adaptor and the universal board.

As shown in Figure 6, the initial default LED display is static and retains full-color, steady lighting.

Figure 6. Initial display



Setting1 and Setting2 are summarized in Table 2 below:

Table 2: Setting1/Setting2 table

	Pin	Description
	(left to right)	
Setting1	00000000	Static full color steady lighting
	10000000	Fade in/out display
	01000000	Gradient display
	00100000	Color chase display
	00010000	Reverse color chase display
	00001000	Rainbow Chase display
	00000100	Meteor light display
	00000010	Returning meteor light display
Setting2	Pin	Description
	(left to right)	
	10000000	AL58263/Q CMD [4] current gain
	01000000	AL58263/Q CMD [5] current gain
	00100000	AL58263/Q CMD [6] current gain
	00010000	AL58263/Q CMD [7] current gain
	00001000	AL58263/Q CMD [8] current gain
	00000100	AL58263/Q CMD [9] current gain
00000010	AL58263/Q CMD [12] APDM/PWM mode	
00000001	AL58263/Q CMD [13] External/Internal GCK	

Fade in/out display

Turn on setting1 pin 1, then press the RESET button. This will activate the fade-in/fade-out display, as shown in Figure 7.

Figure 7. Fade in/out display

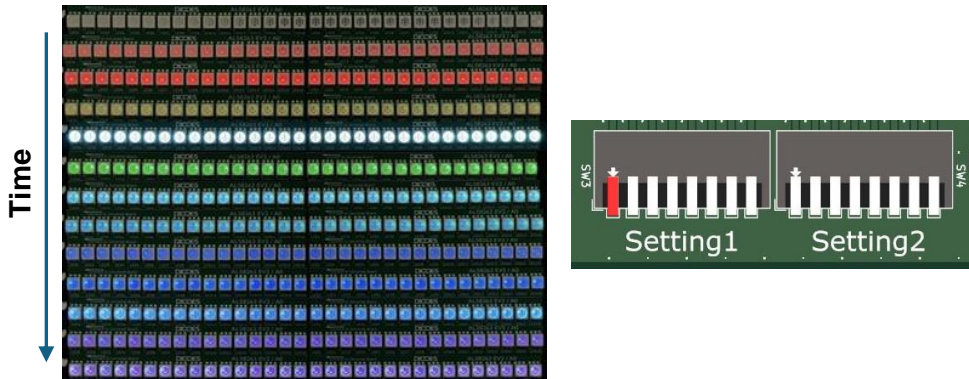

Quick Start Guide (continued)

Gradient display

Turn on setting1 pin 2, then press the RESET button. This will activate the fade-in/fade-out display, as shown in Figure 8.

Figure 8. Gradient display

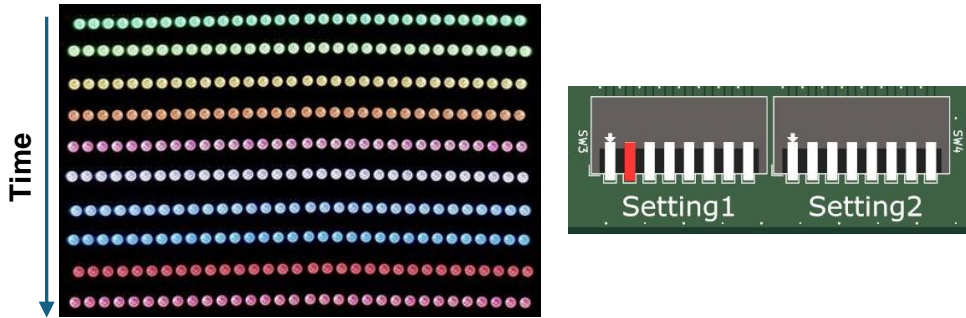

Color chase display

Turn on setting1 pin 3, then press the RESET button. This will activate the color chase display from left to right, as shown in Figure 9.

Figure 9. Color chase display

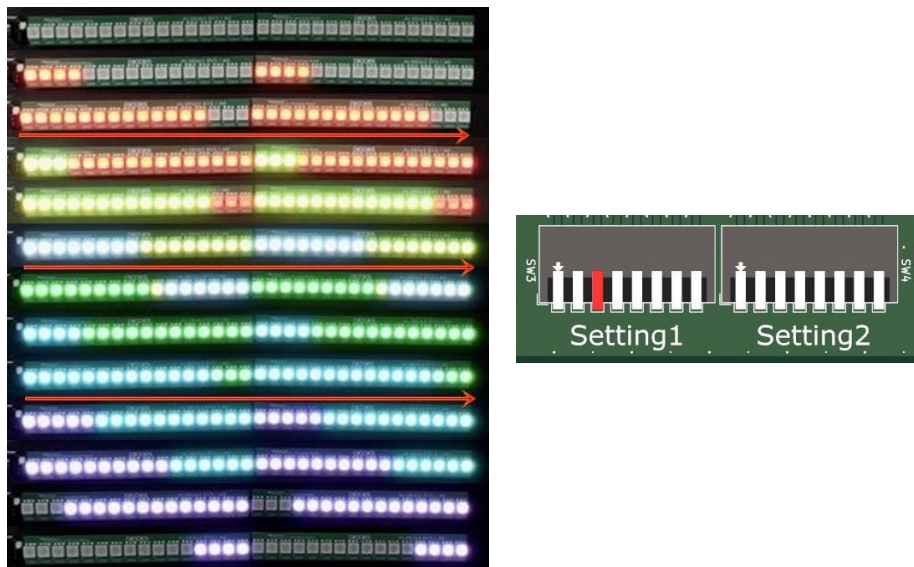

Quick Start Guide (continued)

Reverse color chase display

Turn on setting1 pin 4, then press the RESET button. This will activate the reverse color chase display from right to left, as shown in Figure 10.

Figure 10. Reverse color chase display

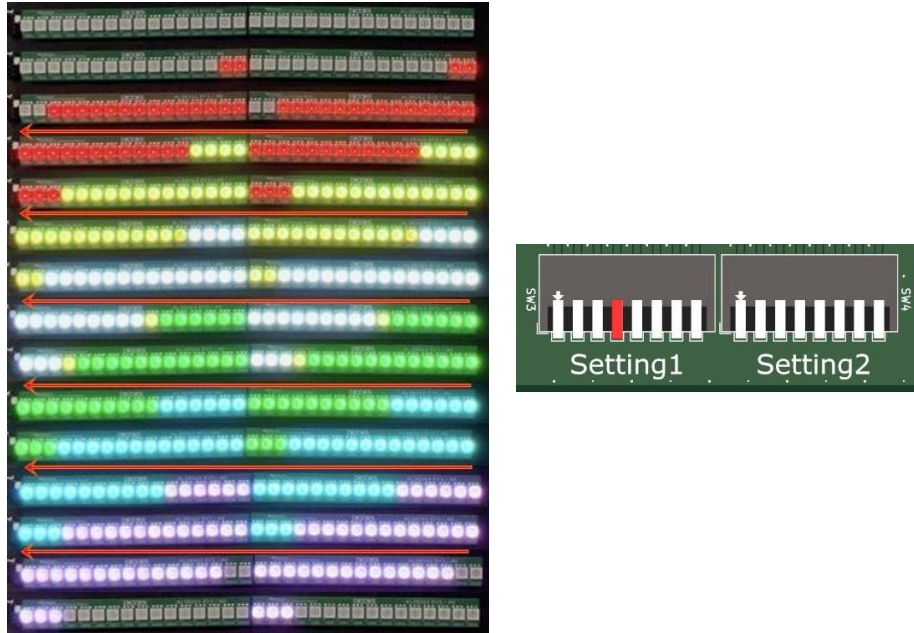

Rainbow Chase display

Turn on setting1 pin 5, then press the RESET button. This will activate the rainbow Chase display, which flows sequentially in full color from left to right, as shown in Figure 11.

Figure 11. Rainbow Chase display

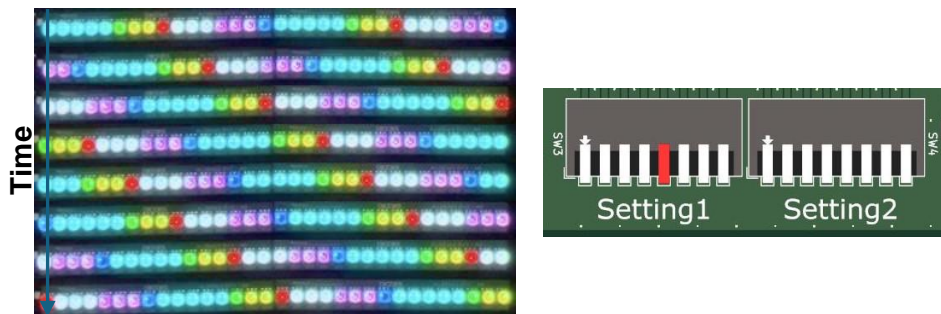

Quick Start Guide (continued)

Meteor light display

Turn on setting1 pin 6, then press the RESET button. This will activate the meteor light display, which is akin to a “meteor crossing the sky” from right to left, as shown in Figure 12.

Figure 12. Meteor light display

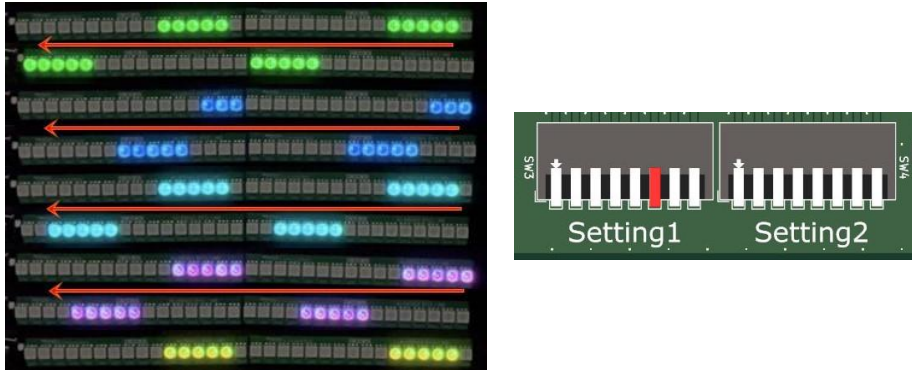

Returning meteor light display

Turn on setting1 pin 7, then press the RESET button. This will activate the meteor light display, which is akin to a “meteor going back and forth” from side to side, as shown in Figure 13.

Figure 13. Returning meteor light display

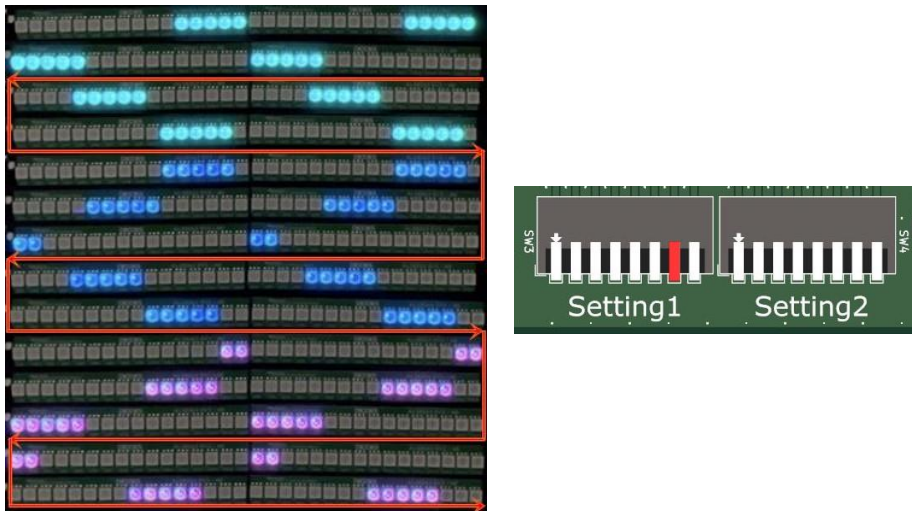

Software Programming Procedure

The universal board uses the M0A23EC1ACU automotive 32-bit microcontroller based on Arm® Cortex®-M0 core as the control unit. You can download the latest demo program update from the Diodes official website, or modify and test your own program.

Before proceeding, please make sure you have the Nu-Link Debug Adapter and ICP programming tool installed. For more details, please refer to the Nu-Link Debug Adapter User's Manual.

Hardware Requirements

Minimum system requirements for PC is shown in Table 3 below:

Table 3: PC minimum requirements

#	Description	Requirement
1	OS	Windows 7, Windows 10, or later (64-bit recommended)
2	CPU	Intel Core i3 or higher
3	RAM	2GB RAM minimum (4GB recommended)
4	Storage	500MB free disk space
5	USB Port	One free USB 2.0/3.0 port

Installation and Setup

Installing the NuMicro ICP Programming Tool

Install Nu-Link Driver: If you haven't already installed the Nu-Link driver, it can be found in the same download section from Nuvoton's website. This driver is required for the Nu-Link Debug Adapter to communicate with the PC.

[NuMicro_ICP_Programming_Tool_V3.17.7691r](#)

Download and Install: After downloading the NuMicro ICP Programming Tool, run the installer and follow the on-screen instructions to complete the setup.

Hardware Connections

Nu-Link to Universal Board Pin Mapping:

To correctly program the M0A23EC1ACU using the Nu-Link Debug Adapter, follow this pin mapping:

- Nu-Link VCC (Pin 1) → Universal Board 5V
- Nu-Link DAT (Pin 2) → Universal Board DAT
- Nu-Link CLK (Pin 4) → Universal Board CLK
- Nu-Link RESET (Pin 6) → Universal Board RESET
- Nu-Link GND (Pin 8) → Universal Board GND

Ensure that all connections between the Nu-Link and the universal board are accurate and secure, as shown in Figure 14.

Figure 14. Hardware Connections

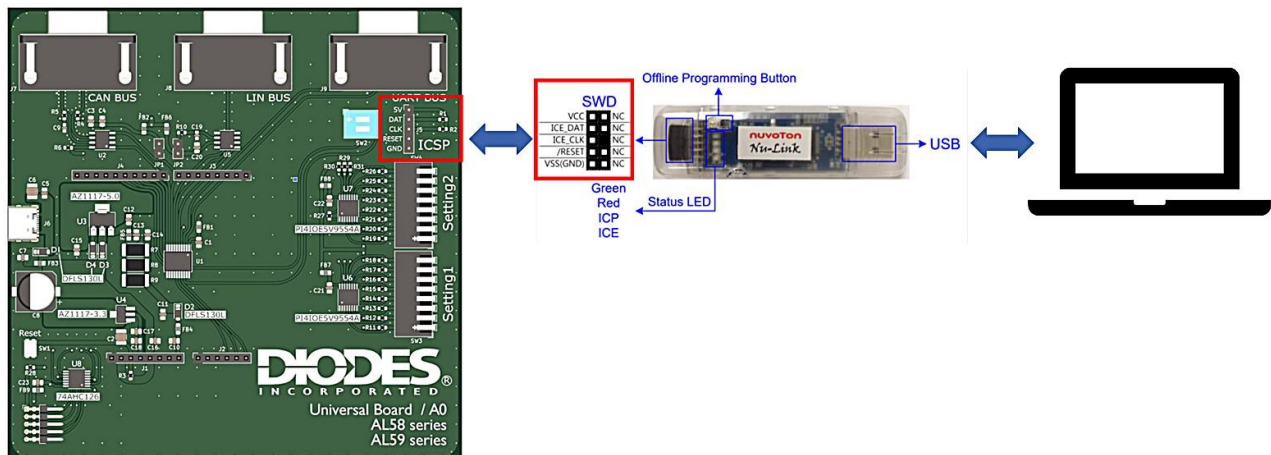

Software Programming Procedure (continued)

Update Firmware

1. Open NuMicro ICP Programming Tool: After hardware setup, launch the NuMicro ICP Programming Tool on your PC, as shown in Figure 15.
2. Select Target Chip: In the tool, select M0A21/M0A23 series from the device list.
3. Connect: Link the Nu-Link Debug Adaptor
4. Load Fire: Click APROM to choose the firmware hex (.hex) file, which was downloaded from the Diodes website.
5. Program the Device: Click Start to start flashing the firmware onto the M0A23EC1ACU. The software will indicate progress and completion of the process.

Figure 15. NuMicro ICP Programming Tool setting

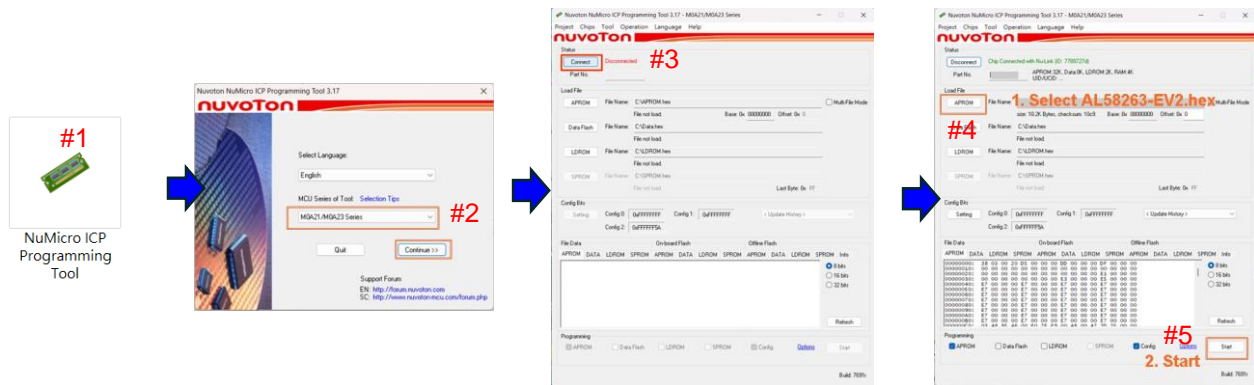

Evaluation Board Schematic (continued)

Figure 17. AL58263 Evaluation Board Schematic

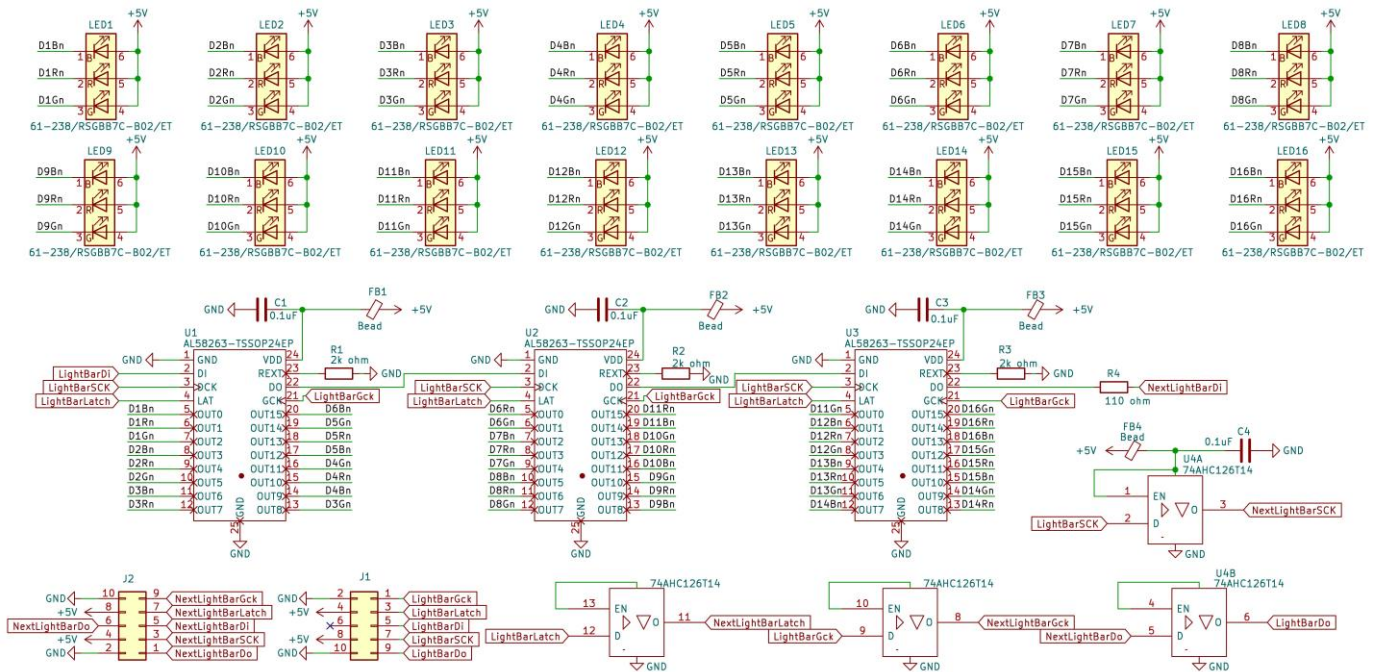
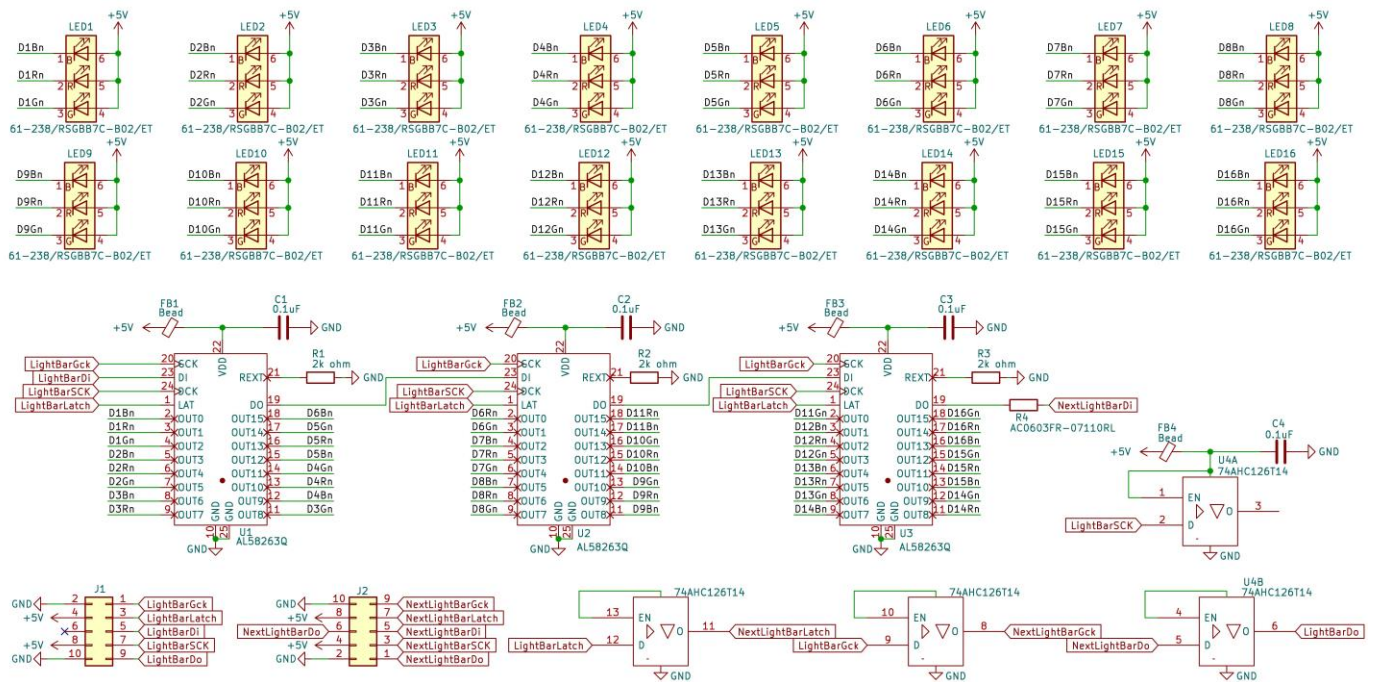

Figure 18. AL58263Q Evaluation Board Schematic



Evaluation Board Layout

Universal Board

Figure 19. Universal PCB Top Layer View

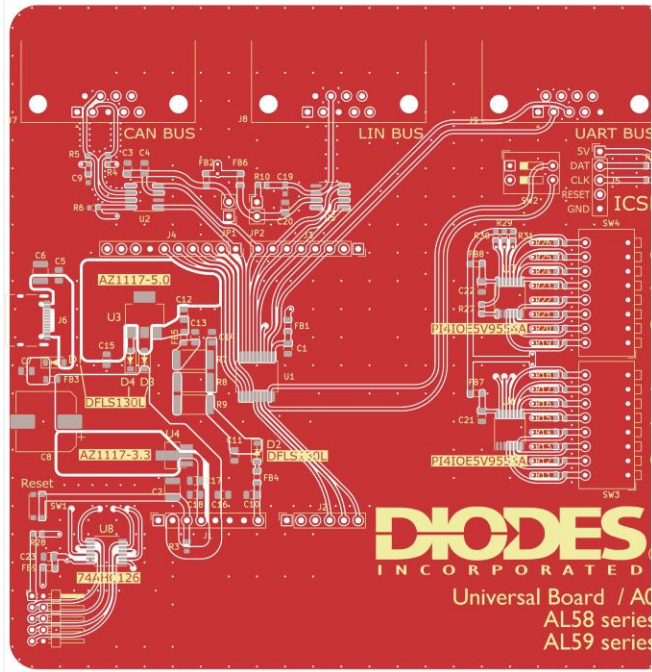
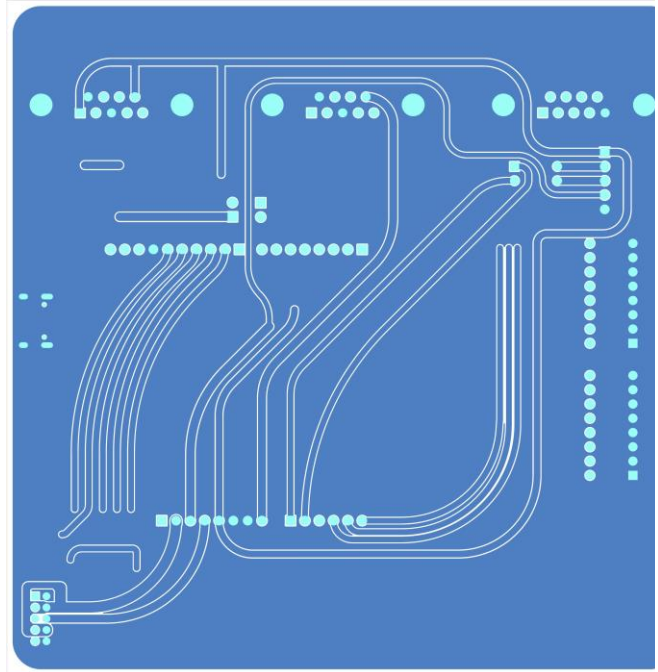

Figure 20. Universal PCB Bottom Layer View



Evaluation Board Layout (continued)

AL58263EV2 Board

Figure 21. AL58263EV2 PCB Top Layer View

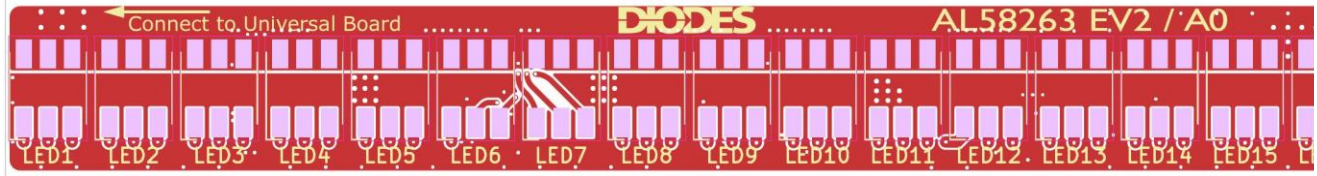

Figure 22. AL58263EV2 PCB Layer1 View

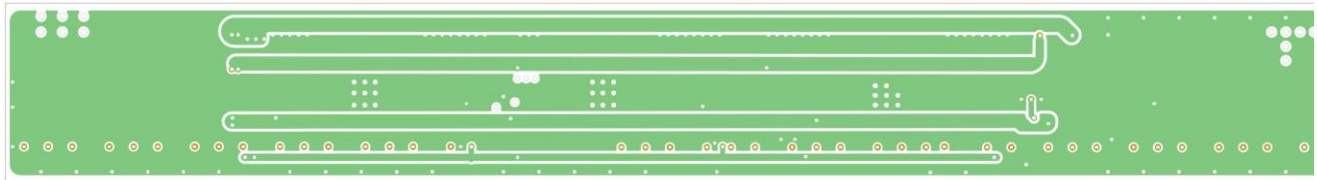

Figure 23. AL58263EV2 PCB Layer2 View

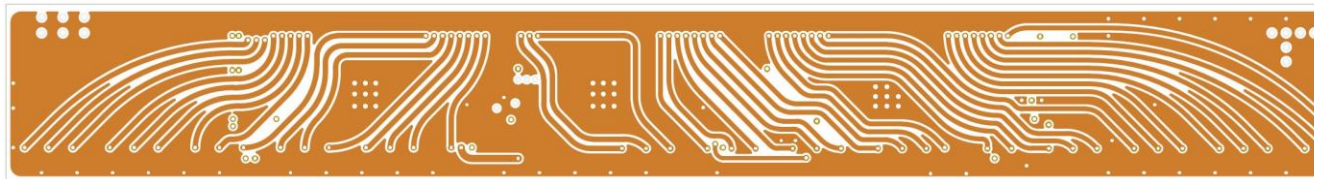
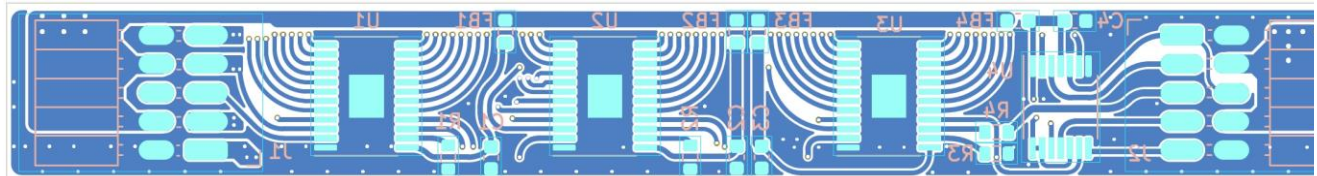

Figure 24. AL58263EV2 PCB Bottom Layer View



Evaluation Board Layout (continued)

AL58263QEV2 Board

Figure 25. AL58263QEV2 PCB Top Layer View

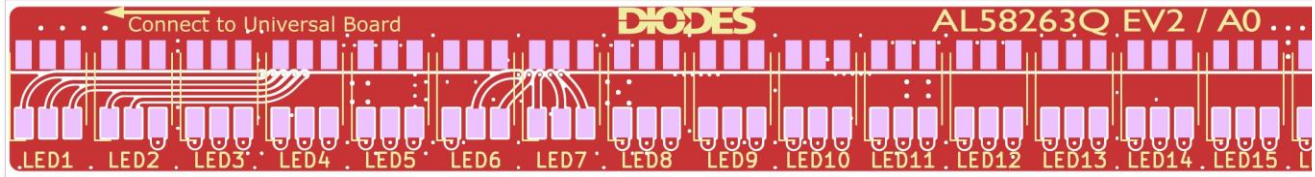

Figure 26. AL58263EV2 PCB Layer1 View

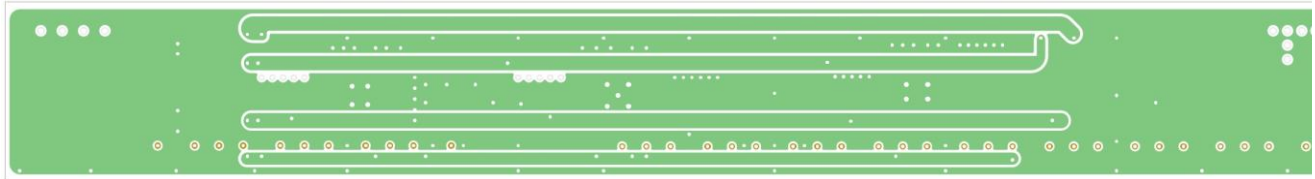

Figure 27. AL58263EV2 PCB Layer2 View

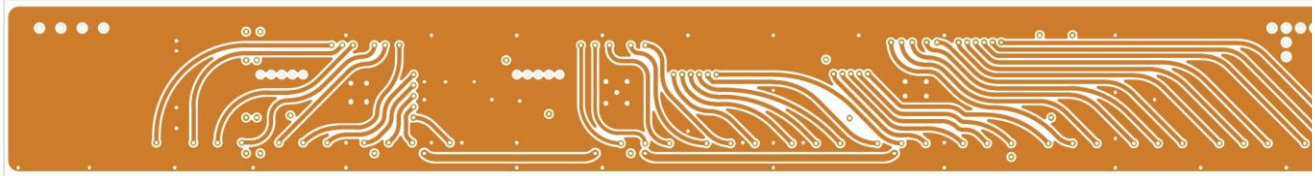
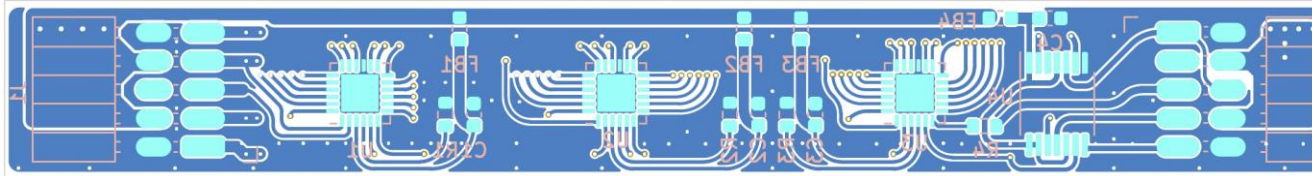

Figure 28. AL58263QEV2 PCB Bottom Layer View



Bill of Materials

Universal Evaluation Board

Location	Description	Manufacturer	Part Number	Package
D1, D2, D3, D4	Schottky Diodes, If=1A, Reverse Voltage=360mV, Reverse Voltage=30V	DIODES	DFLS130L-7	PowerDI-123-2
U8	Buffers & Line Drivers QUAD 3-STATE BUFFERS OE HI 8mA VCC 4.5V	DIODES	74AHC126T14	TSSOP-14
U6, U7	8-bit I ² C-bus and SMBus I/O port with interrupt	DIODES	PI4IOE5V9554A	TSSOP-16
U4	1A LDO, VOUT=3.3V	DIODES	AZ1117-3.3TRG1	SOT223
U3	1A LDO, VOUT=5V	DIODES	AZ1117-5.0TRG1	SOT223
U5	LIN Transceivers LIN 2.1/SAE J2602 transceiver	NXP	TJA1021T	SOIC-8
U2	CAN Interface IC High-speed CAN transceiver	NXP	TJA1051T-3	SOIC-8
U1	automotive 32-bit microcontroller based on Arm® Cortex®-M0 core, AEC Q100 Grade 1	Novoton	M0A23EC1ACU	TSSOP28
FB1~FB9	300mΩ ±25% 1kΩ@100MHz 0805 Ferrite Beads	YJYCOIN	YI201209U102-1R0T	0805
C1, C3, C4, C5, C7, C10, C11, C12, C14, C15, C16, C17, C20~C23	Capacitor SMD, 50 V 0.1uF X7R AEC-Q200	YAGEO	AC0805KRX7R9BB104	0805
C2, C6	Capacitor SMD, 50V 10uF X7R AEC-Q200	TAIYO YUDEN	UMK325AB7106KMHP	1210
C8	Aluminum Electrolytic Capacitors SMD, Low ESR, 35V 330uF	Rubycon	35TZV330M10X10.5	10x10.5
C9	Capacitor SMD, 100V 4700pF X7R 10% AEC-Q200	YAGEO	AC0603KRX7R0BB472	0603
C13, C18	Capacitor SMD, 16V 2.2uF X7R 10% AEC-Q200	YAGEO	AC0805KKX7R7BB225	0805
C19	Capacitor SMD, 100V 220pF X7R 10%	HRE	CAI0603X7R221K101JT	0603
J6	SMD USB Connectors, USB: 5A USB 3.1 1 Horizontal attachment 16P Female SMD USB Connectors	SHOU HAN	TYPE-C 16PIN 2MD	TYPE-C 16P
J7, J8, J9	Connectors/D-Sub / VGA Connectors	XUNPU	D-SUB-DR-9PCM-CB	D-Sub
R1, R2	Resistor SMD, 100kΩ 1% 0.1W AEC-Q200	PANASONIC	ERJ3EKF1003V	0603
R3, R11, R12, R13, R14, R15, R16, R17, R18, R19, R20, R21, R22, R23, R24, R25, R26	Resistor SMD, 10kΩ 1% 0.1W AEC-Q200	PANASONIC	ERJ3EKF1002V	0603
R4, R5	Resistor SMD, 60.4kΩ 1% 1/8W AEC-Q200	YAGEO	AC0805FR-7W60R4L	0805
R6, R10	Resistor SMD, 100kΩ 1% 0.1W AEC-Q200	PANASONIC	ERJ3EKF1001V	0603
R7, R8, R9	Resistor SMD, 1Ω 5% 1W	YAGEO	RC2512JK-071RL	2512
R27	Resistor SMD, 110Ω 1% 0.1W AEC-Q200	YAGEO	AC0603FR-07110RL	0603

AL58263 EV2

Location	Description	Manufacturer	Part Number	Package
U1, U2, U3	16-Channel, 16-Bit Grayscale PWM Dimming LED Driver	DIODES	AL58263	TSSOP-24EP
U4	Buffers & Line Drivers QUAD 3-STATE BUFFERS OE HI 8mA VCC 4.5V	DIODES	74AHC126T14	TSSOP-14
LED1~, LED16	RGB LEDs ROHS	Everlight	61-238/RSGBB7C-B02/ET	SMD5050
FB1, FB2, FB3, FB4	Ferrite Beads 1000 OHM 25%	Murata	BLM18AG102SN1D	0603
C1, C2, C3, C4	Capacitor SMD, 50 V 0.1uF X7R AEC-Q200	YAGEO	AC0805KRX7R9BB104	0805
R1, R2, R3	Resistor SMD, 2kΩ 0.1% 0.1W	PANASONIC	ERA3AEB202V	0603
R4	Resistor SMD, 110Ω 1% 0.1W AEC-Q200	YAGEO	AC0603FR-07110RL	0603

Bill of Materials (continued)

AL58263Q EV2

Location	Description	Manufacturer	Part Number	Package
U1, U2, U3	16-Channel, 16-Bit Grayscale PWM Dimming LED Driver	DIODES	AL58263Q	W-QFN4040-24EP
U4	Buffers & Line Drivers QUAD 3-STATE BUFFERS OE HI 8mA VCC 4.5V	DIODES	74AHC126T14	TSSOP-14
LED1~, LED16	RGB LEDs ROHS	Everlight	61-238/RSGBB7C-B02/ET	SMD5050
FB1, FB2, FB3, FB4	Ferrite Beads 1000 OHM 25%	Murata	BLM18AG102SN1D	0603
C1, C2, C3, C4	Capacitor SMD, 50 V 0.1uF X7R AEC-Q200	YAGEO	AC0805KRX7R9BB104	0805
R1, R2, R3	Resistor SMD, 2kΩ 0.1% 0.1W	PANASONIC	ERA3AEB202V	0603
R4	Resistor SMD, 110Ω 1% 0.1W AEC-Q200	YAGEO	AC0603FR-07110RL	0603

IMPORTANT NOTICE

1. DIODES INCORPORATED (Diodes) AND ITS SUBSIDIARIES MAKE NO WARRANTY OF ANY KIND, EXPRESS OR IMPLIED, WITH REGARDS TO ANY INFORMATION CONTAINED IN THIS DOCUMENT, INCLUDING, BUT NOT LIMITED TO, THE IMPLIED WARRANTIES OF MERCHANTABILITY, FITNESS FOR A PARTICULAR PURPOSE OR NON-INFRINGEMENT OF THIRD PARTY INTELLECTUAL PROPERTY RIGHTS (AND THEIR EQUIVALENTS UNDER THE LAWS OF ANY JURISDICTION).
2. The Information contained herein is for informational purpose only and is provided only to illustrate the operation of Diodes' products described herein and application examples. Diodes does not assume any liability arising out of the application or use of this document or any product described herein. This document is intended for skilled and technically trained engineering customers and users who design with Diodes' products. Diodes' products may be used to facilitate safety-related applications; however, in all instances customers and users are responsible for (a) selecting the appropriate Diodes products for their applications, (b) evaluating the suitability of Diodes' products for their intended applications, (c) ensuring their applications, which incorporate Diodes' products, comply the applicable legal and regulatory requirements as well as safety and functional-safety related standards, and (d) ensuring they design with appropriate safeguards (including testing, validation, quality control techniques, redundancy, malfunction prevention, and appropriate treatment for aging degradation) to minimize the risks associated with their applications.
3. Diodes assumes no liability for any application-related information, support, assistance or feedback that may be provided by Diodes from time to time. Any customer or user of this document or products described herein will assume all risks and liabilities associated with such use, and will hold Diodes and all companies whose products are represented herein or on Diodes' websites, harmless against all damages and liabilities.
4. Products described herein may be covered by one or more United States, international or foreign patents and pending patent applications. Product names and markings noted herein may also be covered by one or more United States, international or foreign trademarks and trademark applications. Diodes does not convey any license under any of its intellectual property rights or the rights of any third parties (including third parties whose products and services may be described in this document or on Diodes' website) under this document.
5. Diodes' products are provided subject to Diodes' Standard Terms and Conditions of Sale (<https://www.diodes.com/about/company/terms-and-conditions/terms-and-conditions-of-sales/>) or other applicable terms. This document does not alter or expand the applicable warranties provided by Diodes. Diodes does not warrant or accept any liability whatsoever in respect of any products purchased through unauthorized sales channel.
6. Diodes' products and technology may not be used for or incorporated into any products or systems whose manufacture, use or sale is prohibited under any applicable laws and regulations. Should customers or users use Diodes' products in contravention of any applicable laws or regulations, or for any unintended or unauthorized application, customers and users will (a) be solely responsible for any damages, losses or penalties arising in connection therewith or as a result thereof, and (b) indemnify and hold Diodes and its representatives and agents harmless against any and all claims, damages, expenses, and attorney fees arising out of, directly or indirectly, any claim relating to any noncompliance with the applicable laws and regulations, as well as any unintended or unauthorized application.
7. While efforts have been made to ensure the information contained in this document is accurate, complete and current, it may contain technical inaccuracies, omissions and typographical errors. Diodes does not warrant that information contained in this document is error-free and Diodes is under no obligation to update or otherwise correct this information. Notwithstanding the foregoing, Diodes reserves the right to make modifications, enhancements, improvements, corrections or other changes without further notice to this document and any product described herein. This document is written in English but may be translated into multiple languages for reference. Only the English version of this document is the final and determinative format released by Diodes.
8. Any unauthorized copying, modification, distribution, transmission, display or other use of this document (or any portion hereof) is prohibited. Diodes assumes no responsibility for any losses incurred by the customers or users or any third parties arising from any such unauthorized use.
9. This Notice may be periodically updated with the most recent version available at <https://www.diodes.com/about/company/terms-and-conditions/important-notice>

The Diodes logo is a registered trademark of Diodes Incorporated in the United States and other countries.

All other trademarks are the property of their respective owners.

© 2024 Diodes Incorporated. All Rights Reserved.

www.diodes.com