

General Description

The AL8890Q is a synchronous buck converter with internal compensation and switching frequency adjustable up to 2.5MHz. The device integrates a 120mΩ high-side power MOSFET and a 55mΩ low-side power MOSFET to provide high-efficiency DC-DC conversion.

The AL8890Q enables a continuous load current of up to 3.5A, with efficiency as high as 95% in enhanced biased. The device features current mode control operation, which enables easy loop stabilization supporting a wide range of output loading, suitable for both CV (Constant Voltage) and CC (Constant Current) applications.

The AL8890Q simplifies board layout and reduces space requirements with its high switching frequency and use of smaller size inductor and built-in MOSFET, making it ideal for power management.

The AL8890Q is available in the standard Green U-QFN4040-16 package.

Applications

- Automotive infotainment
- Automotive exterior and interior LED lighting systems
- Automotive motor controls
- Automotive and industrial power systems

Key Features

- AEC-Q100 Grade1
- VIN 3.8V to 60V
- Wide VOUT Range: 0.8V to near 100% of VIN
- VOUT 1% Accuracy
- VFB Adjustable through SS/TR Pin
- Synchronous Rectification > 95% Efficiency @12V
 - High-Side (120mΩ) Power MOSFET
 - Low-Side (55mΩ) Power MOSFETS
- Low Quiescent Current 43μA
- Switching Frequency 300kHz to 2.5MHz
- Force PWM or PFM Mode through MYSNC
- Synchronization to External Clock
- Programmable Startup Control
 - Startup with Pre-Biased Output
 - External Soft-Start with Tracking
 - High Voltage Enable Pin with High Precision
- Protection and Diagnosis Functions
 - Power Good (PG) Detection
 - Thermal Shutdown Protection
- **Totally Lead-Free & Fully RoHS Compliant (Notes 1 & 2)**
- **Halogen and Antimony Free. “Green” Device (Note 3)**
- **The AL88902Q is suitable for automotive applications requiring specific change control; this part is AEC-Q100 qualified, PPAP capable, and manufactured in IATF 16949 certified facilities.**
<https://www.diodes.com/quality/product-definitions/>

Notes:

1. No purposely added lead. Fully EU Directive 2002/95/EC (RoHS), 2011/65/EU (RoHS 2) & 2015/863/EU (RoHS 3) compliant.
2. See <https://www.diodes.com/quality/lead-free/> for more information about Diodes Incorporated's definitions of Halogen- and Antimony-free, "Green" and Lead-free.
3. Halogen- and Antimony-free "Green" products are defined as those which contain <900ppm bromine, <900ppm chlorine (<1500ppm total Br + Cl) and <1000ppm antimony compounds.
4. Automotive products are AEC-Q100 qualified and are PPAP capable. Refer to <https://www.diodes.com/quality/>.

Evaluation Board

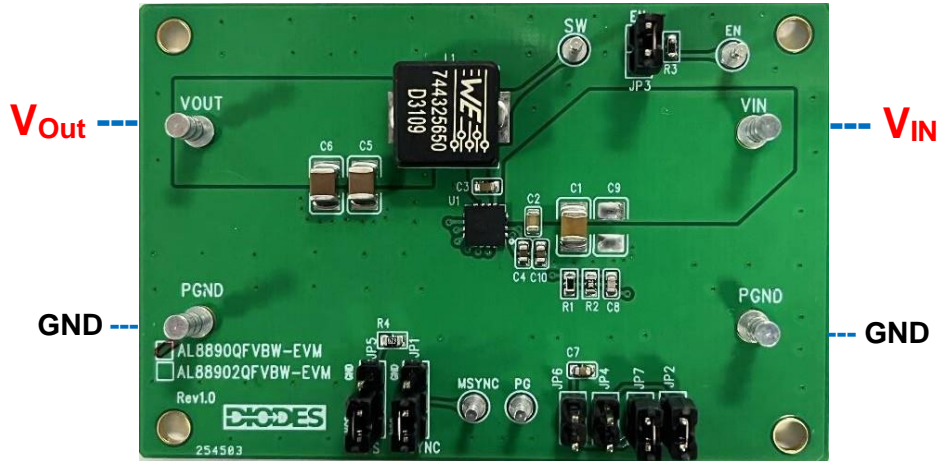

Figure 1: AL8890QFVBW EVM Top View

Board Layout

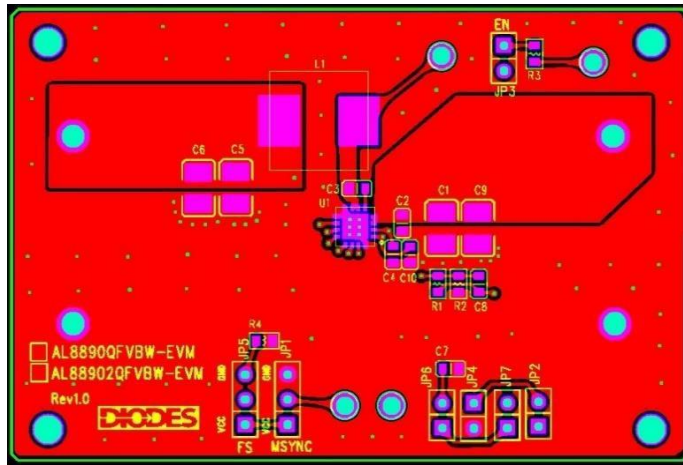

Figure 2: PCB Top Layer (Top View)

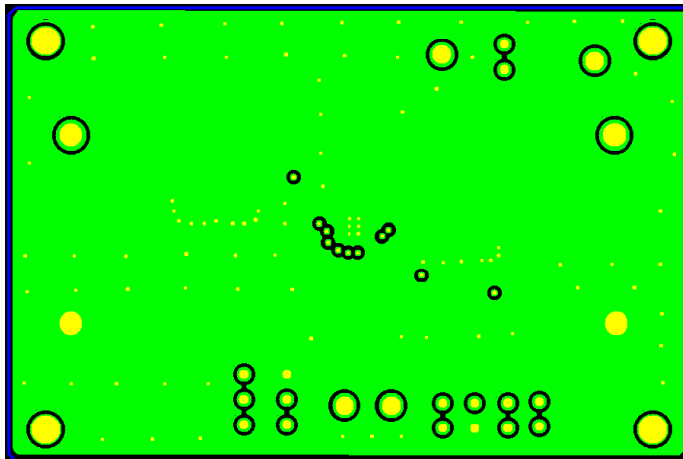

Figure 3: PCB Second Layer (Top View)

Board Layout (continued)

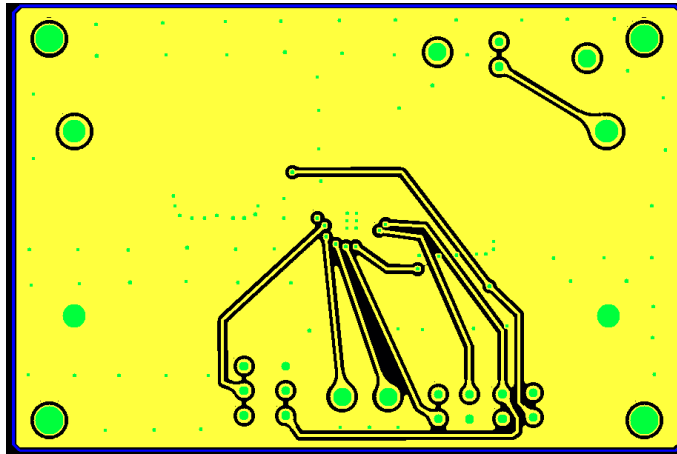

Figure 4: PCB Third Layer (Top View)

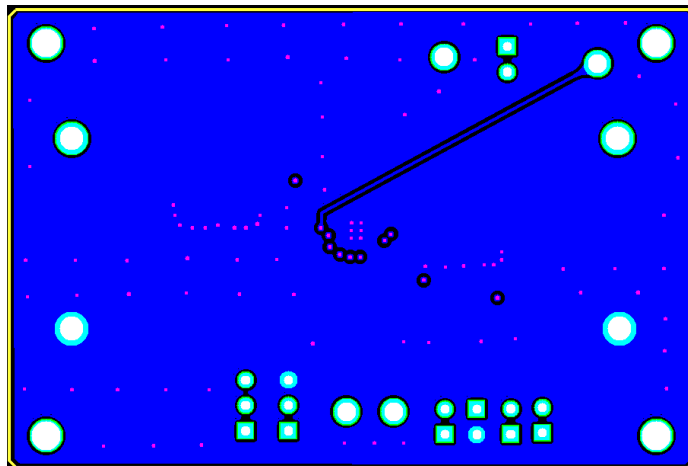

Figure 5: PCB Bottom Layer (Top View)

Quick Start Guide

The AL8890QFVBW-EVM board has a simple layout and allows access to the appropriate signals through test points. To evaluate the performance of the AL8890Q, follow the procedure below:

1. Insert jumpers to configure the EVM board setting as described in the Application Information sections of the device datasheet.
2. Use jumper JP3 (100KΩ to VIN) set device enabled or JP2 (GND) to disable the device.
3. Remove jumpers JP2 and JP3 and connect external voltage source on EN pin directly.
4. Use jumper JP5 to set FS to default 500KHz (VCC) or 2.5MHz (GND).
5. Use jumper JP1 to set MSYNC to forced PWM (VCC) or PFM (GND) operation.
6. Remove jumper JP1 and force an external clock source on MSYNC pin for synchronization with positive edge trigger and PWM.
7. Use jumper JP6 for default external soft start (C7) of 2ms.
8. Remove jumper JP6 and use jumper JP7 (VCC) for internal soft start of 1.7ms.
9. Use jumper JP8 to connect BIAS pin to PGND.
10. Use jumper JP9 to connect BIAS pin to VOUT.
11. Remove JP8 and JP9 and connect an external voltage source on BIAS pin (<15V).
12. Connect a 12V power supply between the VIN and PGND terminals. Make sure the power supply is turned off.
13. Connect an adjustable current or resistive load to the VOUT and PGND terminals.
14. Turn on the power supply. Do not turn on the power supply until all connections are completed and fully checked.
15. The EVM board should now power up with a 5V output voltage.
16. Increase the load current and observe the output voltage change.
17. Check for the stable operation of the SW and VOUT signal on the oscilloscope.
18. Measure the switching frequency on SW probe jack in the EVM board.
19. Measure the output ripple on the VOUT probe jack in the EVM board.

Measurement/Performance Guidelines

When measuring the output voltage ripple, maintain the shortest possible ground lengths on the oscilloscope probe. Long ground leads can erroneously inject high frequency noise into the measured ripple.

Evaluation Board Schematic

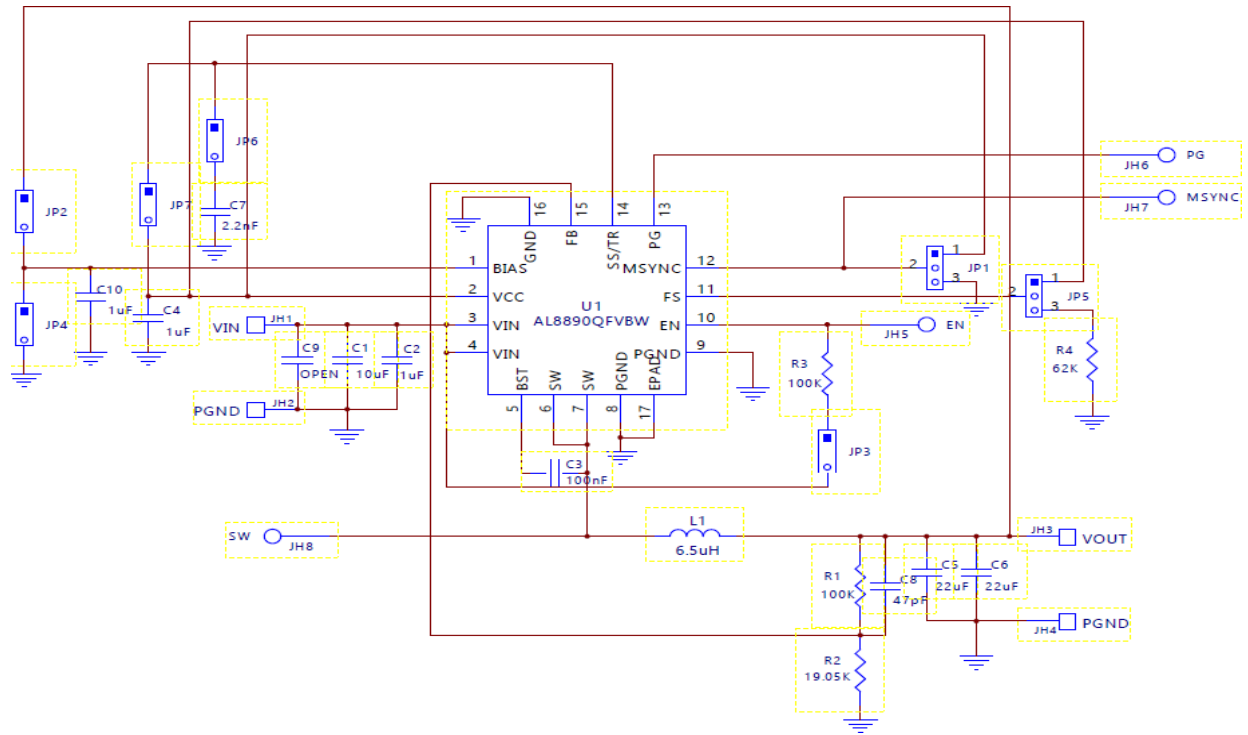

Figure 6: Schematic Circuit

Bill of Materials

Qty	Ref	Value	Description	Package	Manufacturer	Manufacturer P/N
1	C1	10uF	Ceramic Capacitor 100V	1210	Murata	GRM32EC72A106KE05L
1	C2	1uF	Ceramic Capacitor 100V X5R 20%	805	Murata	GRJ21BC72A105KE11L
1	C3	100nF	Ceramic Capacitor 50V X7R 10%	603	TDK	CGA3E2X7R1H104KTOYON
2	C4, C10	1uF	Ceramic Capacitor 25V X7R 10%	603	Taiyo Yuden	963-TMK107B7105KA-T
2	C5, C6	22uF	Ceramic Capacitor 25V X5R	1210	Taiyo Yuden	TMK325BJ226MM-T
1	C7	2.2nF	Ceramic Capacitor 50V X7R 10%	603	AVX	0603C222KAT2A
1	C8	47pF	Ceramic Capacitor 100V X7R 20%	603	Kemet	C0603C470K1RACTU
2	R1, R3	100KΩ	Film Resistor	603	Panasonic	ERJ-3EKF1003V
1	R2	19.1KΩ	Film Resistor	603	Yageo	AC0603FR-0719K1L
1	R4	62KΩ	Film Resistor	603	Yageo	AC0603FR-1362KL
1	L1	6.5uH	DCR=12.5mΩ, Isat=10A	10.5x10.5x4.7mm	Würth	744325650
5	JP2, 3, 4, 6 7		PCB Header, 40 POS	1X2	3M	2340-611TG
2	JP1 & 5		PCB Header, 40 POS	1X3	3M	2340-611TG
4	PG, MSYNC, SW & EN		PCB Turrent Term 0.082"	0.082"	Keystone	1573-2
4	VIN, VOUT & PGNDx2		PCB Turrent Term 0.094"X1/16	0.094"	Keystone	1598-2
1	AL8890Q		IC	U-QFN4040-16	Diodes	Customer Provides

Typical Performance Characteristics (TA = +25°C, VIN = 12V, VOUT = 5V, fsw = 400kHz)

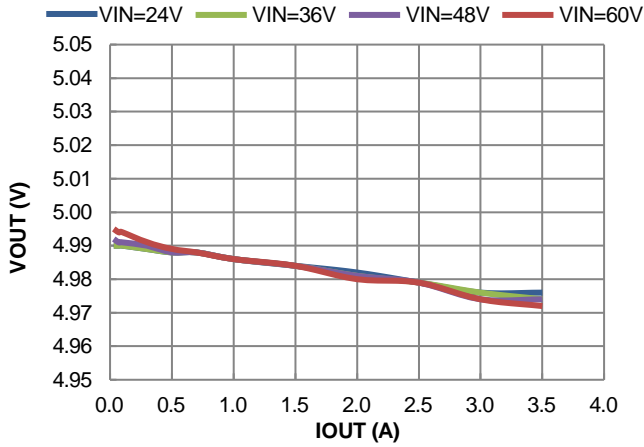

Figure 7. PWM Load Regulation

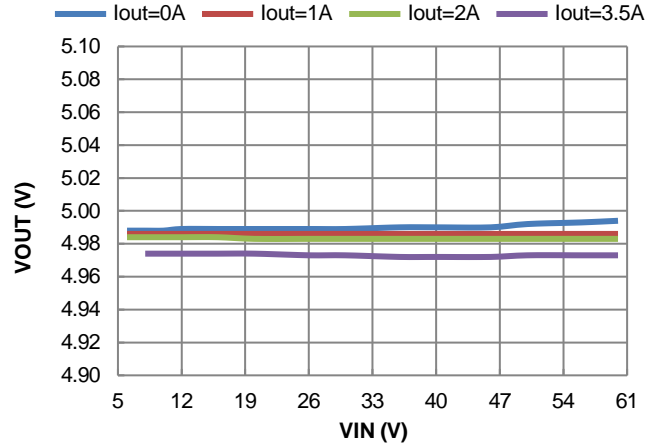

Figure 8. PWM Line Regulation

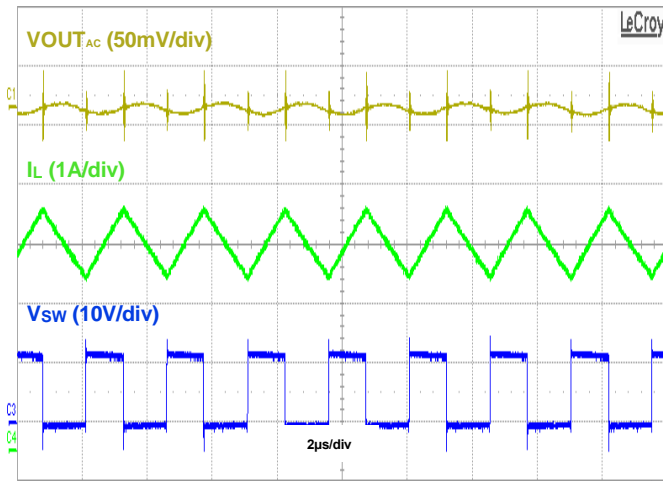

Figure 9. Output Ripple, VIN=12V, VOUT = 5V @3.5A, PWM

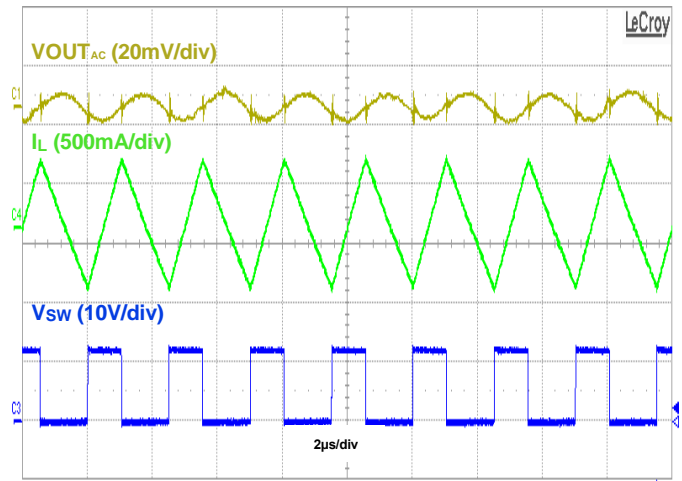

Figure 10. Output Ripple VIN = 12V, VOUT = 5V @50mA, PWM

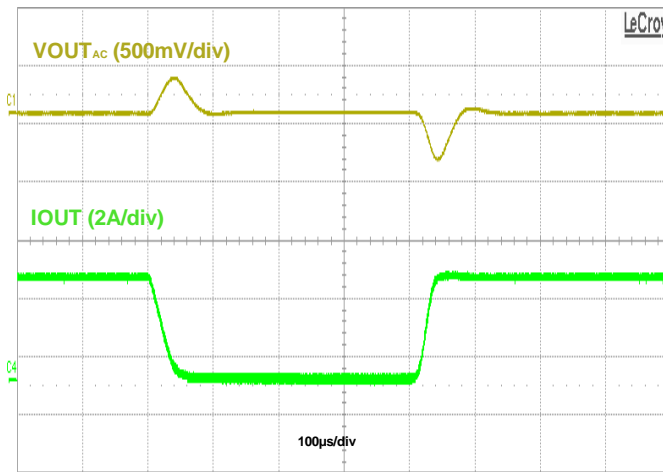

Figure 11. Load Transient, IOUT = 50mA to 3.5A to 50mA, PWM

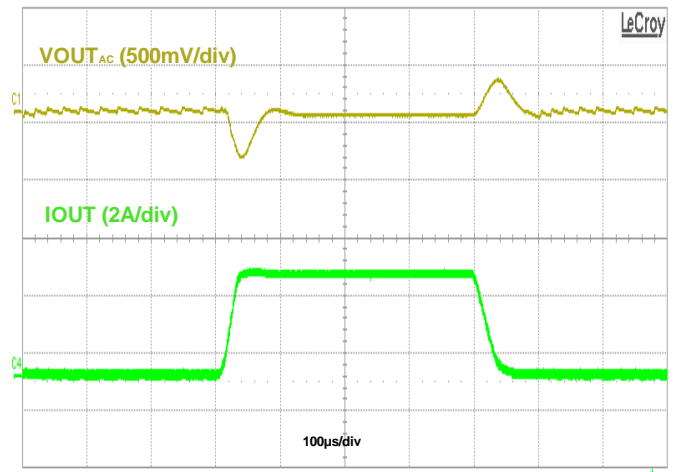

Figure 12. Load Transient, IOUT = 50mA to 3.5A to 50mA, PFM

IMPORTANT NOTICE

1. DIODES INCORPORATED (Diodes) AND ITS SUBSIDIARIES MAKE NO WARRANTY OF ANY KIND, EXPRESS OR IMPLIED, WITH REGARDS TO ANY INFORMATION CONTAINED IN THIS DOCUMENT, INCLUDING, BUT NOT LIMITED TO, THE IMPLIED WARRANTIES OF MERCHANTABILITY, FITNESS FOR A PARTICULAR PURPOSE OR NON-INFRINGEMENT OF THIRD PARTY INTELLECTUAL PROPERTY RIGHTS (AND THEIR EQUIVALENTS UNDER THE LAWS OF ANY JURISDICTION).
2. The Information contained herein is for informational purpose only and is provided only to illustrate the operation of Diodes' products described herein and application examples. Diodes does not assume any liability arising out of the application or use of this document or any product described herein. This document is intended for skilled and technically trained engineering customers and users who design with Diodes' products. Diodes' products may be used to facilitate safety-related applications; however, in all instances customers and users are responsible for (a) selecting the appropriate Diodes products for their applications, (b) evaluating the suitability of Diodes' products for their intended applications, (c) ensuring their applications, which incorporate Diodes' products, comply the applicable legal and regulatory requirements as well as safety and functional-safety related standards, and (d) ensuring they design with appropriate safeguards (including testing, validation, quality control techniques, redundancy, malfunction prevention, and appropriate treatment for aging degradation) to minimize the risks associated with their applications.
3. Diodes assumes no liability for any application-related information, support, assistance or feedback that may be provided by Diodes from time to time. Any customer or user of this document or products described herein will assume all risks and liabilities associated with such use, and will hold Diodes and all companies whose products are represented herein or on Diodes' websites, harmless against all damages and liabilities.
4. Products described herein may be covered by one or more United States, international or foreign patents and pending patent applications. Product names and markings noted herein may also be covered by one or more United States, international or foreign trademarks and trademark applications. Diodes does not convey any license under any of its intellectual property rights or the rights of any third parties (including third parties whose products and services may be described in this document or on Diodes' website) under this document.
5. Diodes' products are provided subject to Diodes' Standard Terms and Conditions of Sale (<https://www.diodes.com/about/company/terms-and-conditions/terms-and-conditions-of-sales/>) or other applicable terms. This document does not alter or expand the applicable warranties provided by Diodes. Diodes does not warrant or accept any liability whatsoever in respect of any products purchased through unauthorized sales channel.
6. Diodes' products and technology may not be used for or incorporated into any products or systems whose manufacture, use or sale is prohibited under any applicable laws and regulations. Should customers or users use Diodes' products in contravention of any applicable laws or regulations, or for any unintended or unauthorized application, customers and users will (a) be solely responsible for any damages, losses or penalties arising in connection therewith or as a result thereof, and (b) indemnify and hold Diodes and its representatives and agents harmless against any and all claims, damages, expenses, and attorney fees arising out of, directly or indirectly, any claim relating to any noncompliance with the applicable laws and regulations, as well as any unintended or unauthorized application.
7. While efforts have been made to ensure the information contained in this document is accurate, complete and current, it may contain technical inaccuracies, omissions and typographical errors. Diodes does not warrant that information contained in this document is error-free and Diodes is under no obligation to update or otherwise correct this information. Notwithstanding the foregoing, Diodes reserves the right to make modifications, enhancements, improvements, corrections or other changes without further notice to this document and any product described herein. This document is written in English but may be translated into multiple languages for reference. Only the English version of this document is the final and determinative format released by Diodes.
8. Any unauthorized copying, modification, distribution, transmission, display or other use of this document (or any portion hereof) is prohibited. Diodes assumes no responsibility for any losses incurred by the customers or users or any third parties arising from any such unauthorized use.
9. This Notice may be periodically updated with the most recent version available at <https://www.diodes.com/about/company/terms-and-conditions/important-notice>

The Diodes logo is a registered trademark of Diodes Incorporated in the United States and other countries.
All other trademarks are the property of their respective owners.
© 2024 Diodes Incorporated. All Rights Reserved.

www.diodes.com