

## Description

The AH1711Q/AH1712Q/AH1713Q/AH1714Q is an AEC-Q100 qualified low-voltage, high-sensitivity Hall effect latch IC designed for brushless DC-motor commutation speed measurement, angular or linear encoders and position sensors in automotive applications. To support a wide range of demanding applications, the design is optimized to operate at 2.4V to 5.5V. With chopper stabilized architecture and an internal bandgap regulator to provide temperature compensated supply for internal circuits, the device provides a reliable solution over the whole operating range.

The open-drain output of AH1711Q/AH1712Q/AH1713Q can be switched on when applying South pole with sufficient magnetic near the top of the package, while North pole with sufficient magnetic strength causes the open-drain output switched off (AH1714Q polarity inverted). When the magnetic flux density (B) perpendicular to the package is larger than the operate point (Bop) the output is switched on (pulled low). The output is held latched until magnetic flux density reverses and becomes lower than the release point (Brp).

## Features

- Latch Operation
- High Sensitivity: Bop and Brp of  $\pm 7$  Gauss and  $\pm 18$  Gauss
- Open-Drain Output
- 2.4V to 5.5V Operating Voltage Range
- Chopper Stabilized Design Provides
  - Superior Temperature Stability
  - Minimal Switch Point Drift
  - Enhanced Immunity to Stress
- Good RF Noise Immunity
- Fast 30kHz Sensing Bandwidth
- $-40^{\circ}\text{C}$  to  $+150^{\circ}\text{C}$  Operating Temperature
- ESD: HBM 8kV, CDM 2kV
- AEC-Q100 Grade 0 Qualified
- Industry Standard SOT23 Package
- **Totally Lead-Free & Fully RoHS Compliant (Notes 1 & 2)**
- **Halogen and Antimony Free. "Green Device (Note 3)**
- **The AH1711Q/AH1712Q/AH1713Q/AH1714Q is suitable for automotive applications requiring specific change control; this part is AEC-Q100 qualified, PPAP capable, and manufactured in IATF16949 certified facilities.**

<https://www.diodes.com/quality/product-definitions/>

- Notes:
1. No purposely added lead. Fully EU Directive 2002/95/EC (RoHS), 2011/65/EU (RoHS 2) & 2015/863/EU (RoHS 3) compliant.
  2. See <https://www.diodes.com/quality/lead-free/> for more information about Diodes Incorporated's definitions of Halogen- and Antimony-free, "Green" and Lead-free.
  3. Halogen- and Antimony-free "Green" products are defined as those which contain <900ppm bromine, <900ppm chlorine (<1500ppm total Br + Cl) and <1000ppm antimony compounds.

## Pin Assignments

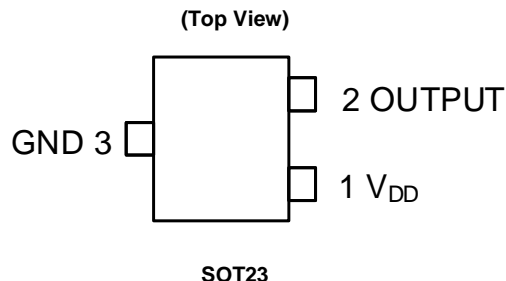

## Applications

- Brushless DC-motor commutation
- Revolution per minute (RPM) measurements
- Wheel speed/angular/speed sensing
- Fuel pumps/windows/sunroofs/sliding doors
- Human machine interface knobs

**Typical Applications Circuit** (Note 4)

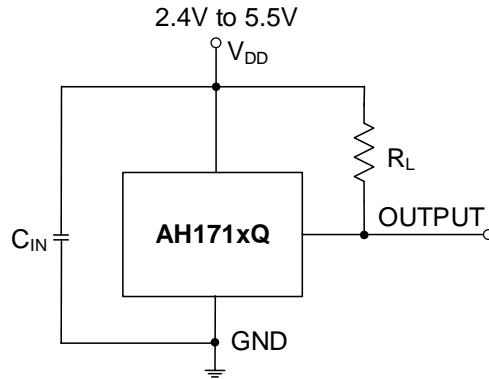

Note: 4. C<sub>IN</sub> is for power stabilization and to strengthen the noise immunity, the recommended capacitance is 10nF to 100nF. R<sub>L</sub> is the pullup resistor.

**Pin Descriptions**

Package: SOT23

Pin Number	Pin Name	Function
1	V <sub>DD</sub>	Power Supply Input
2	OUTPUT	Output
3	GND	Ground

**Functional Block Diagram**

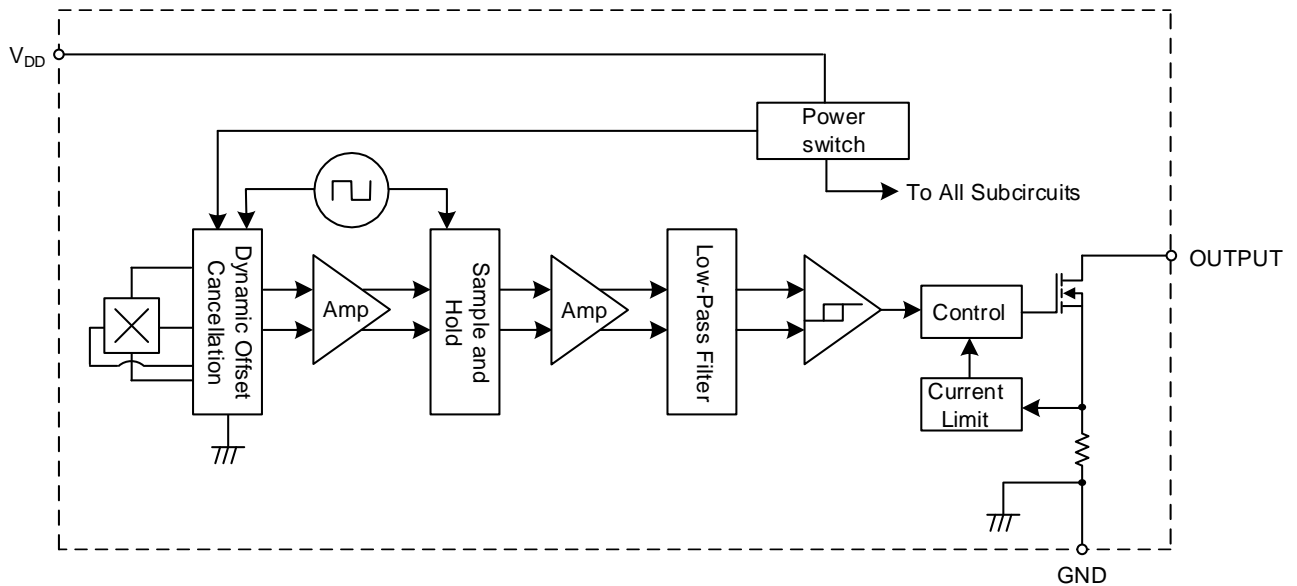

**Absolute Maximum Ratings** (Notes 5 & 6) (@T<sub>A</sub> = +25°C, unless otherwise specified.)

Symbol	Characteristic	Value	Unit
V <sub>DD</sub>	Supply Voltage (Note 6)	-0.3 to 6.0	V
V <sub>OUT_MAX</sub>	Output Off Voltage (Note 6)	6.0	V
I <sub>OUT</sub>	Output Current	60	mA
B	Magnetic Flux Density	Unlimited	
P <sub>D</sub>	Package Power Dissipation	SOT23	230 mW
T <sub>S</sub>	Storage Temperature Range	-65 to +150	°C
T <sub>J</sub>	Maximum Junction Temperature	+170	°C
ESD HBM	Electros Static Discharge Withstand - Human Body Model (HBM)	8	kV
ESD CDM	Electros Static Discharge Withstand - Charged Device Model (CDM)	2	kV

- Notes:
- Stresses greater than those listed under *Absolute Maximum Ratings* can cause permanent damage to the device. These are stress ratings only, and functional operation of the device at these or any other conditions beyond those indicated under *Recommended Operating Conditions* is not implied. Exposure to *Absolute Maximum Ratings* for extended periods can affect device reliability.
  - The absolute maximum V<sub>DD</sub> of 6V is a transient stress rating and is not meant as a functional operating condition. It is not recommended to operate the device at the absolute maximum rated conditions for any period of time.

**Recommended Operating Conditions** (@T<sub>A</sub> = -40°C to +150°C, unless otherwise specified.)

Symbol	Parameter	Rating	Unit
V <sub>DD</sub>	Supply Voltage	2.4 to 5.5	V
I <sub>OUT</sub>	Output Sinking Current	0 to 20	mA
T <sub>A</sub>	Operating Temperature Range	-40 to +150	°C

**Electrical Characteristics** (Notes 7 & 8) (@T<sub>A</sub> = -40°C to +150°C, V<sub>DD</sub> = 2.4V to 5.5V, unless otherwise specified.)

Symbol	Parameter	Conditions	Min	Typ	Max	Unit
V <sub>OL</sub>	Low-Level Output Voltage	I <sub>OUT</sub> = 20mA	—	0.2	0.4	V
I <sub>LKG</sub>	Output Leakage Current (When Output is Off)	V <sub>OUT</sub> = 5.5V, output off	—	< 0.1	3	µA
I <sub>DD</sub>	Supply Current	Output open, T <sub>A</sub> = +25°C	—	2.0	2.8	mA
		Output open, T <sub>A</sub> = -40°C to +150°C	—	—	3.2	mA
t <sub>P_ON</sub>	Device Power-On Time (Startup Time)	V <sub>DD</sub> ≥ 2.4V, B < BRP (min) - 10G B > BOP (max) + 10G (Note 7) dV <sub>DD</sub> /dt > 2V/µs	—	38	70	µs
POS	Power-On State, Output	Power-on time < t <sub>P_ON</sub> , B = 0	Low			—
f <sub>c</sub>	Chopping Frequency	V <sub>DD</sub> ≥ 2.4V	—	800	—	kHz
t <sub>d</sub>	Response Time Delay (Time from Magnetic Threshold Reached to the Start of the Output Rise or Fall)	(Note 9)	—	10	20	µs
t <sub>r</sub>	Output Rising Time (External Pullup Resistor R <sub>L</sub> and Load Capacitance Dependent)	R <sub>L</sub> = 1kΩ, C <sub>L</sub> = 20pF	—	0.2	1	µs
t <sub>f</sub>	Output Falling Time (Internal Switch Resistance and Load Capacitance Dependent)	R <sub>L</sub> = 1kΩ, C <sub>L</sub> = 20pF	—	0.1	1	µs
f <sub>BW</sub>	Sensing Bandwidth	B ≥ ±400G and square wave magnetic field (Note 9)	20	30	—	kHz
I <sub>OCL</sub>	Output Current Limit	B > B <sub>OP</sub> (Note 10)	30	—	60	mA

- Notes:
- When power is initially turned on, V<sub>DD</sub> must be within its correct operating range (2.4V to 5.5V) to guarantee the output sampling. The output state is valid after the startup time of 38µs typical from the operating voltage reaching 2.4V.
  - Typical values are defined at T<sub>A</sub> = +25°C. Maximum and minimum values over the operating temperature range is not tested in production but guaranteed by design, process control and characterization.
  - Guaranteed by design, process control and characterization. Not tested in production.
  - The device will limit the output current to current limit of I<sub>OCL</sub>.

**Magnetic Characteristics** (Notes 11 & 12) ( $T_A = -40^{\circ}\text{C}$  to  $+150^{\circ}\text{C}$ ,  $V_{DD} = 2.4\text{V}$  to  $5.5\text{V}$ , unless otherwise specified.)

Part Name	Symbol	Parameter	Conditions	Min	Typ	Max	Unit	Output Polarity
AH1711Q	Bop	Operation Point	$T_A = -40^{\circ}\text{C}$ to $+125^{\circ}\text{C}$	-2	7	20	Gauss	Direct
			$T_A = -40^{\circ}\text{C}$ to $+150^{\circ}\text{C}$	-5	7	29		
	Brp	Release Point	$T_A = -40^{\circ}\text{C}$ to $+125^{\circ}\text{C}$	-20	-7	2		
			$T_A = -40^{\circ}\text{C}$ to $+150^{\circ}\text{C}$	-29	-7	5		
	B <sub>HY</sub>	Hysteresis (Note 13)	$T_A = -40^{\circ}\text{C}$ to $+125^{\circ}\text{C}$	3.5	14	—		
			$T_A = -40^{\circ}\text{C}$ to $+150^{\circ}\text{C}$	3	14	—		
AH1712Q	Bop	Operation Point	$T_A = -40^{\circ}\text{C}$ to $+125^{\circ}\text{C}$	5	18	37	Gauss	Direct
			$T_A = -40^{\circ}\text{C}$ to $+150^{\circ}\text{C}$	2	18	45		
	Brp	Release Point	$T_A = -40^{\circ}\text{C}$ to $+125^{\circ}\text{C}$	-37	-18	-5		
			$T_A = -40^{\circ}\text{C}$ to $+150^{\circ}\text{C}$	-45	-18	-2		
	B <sub>HY</sub>	Hysteresis (Note 13)	$T_A = -40^{\circ}\text{C}$ to $+125^{\circ}\text{C}$	23	36	—		
			$T_A = -40^{\circ}\text{C}$ to $+150^{\circ}\text{C}$	17.5	36	—		
AH1713Q	Bop	Operation Point	$T_A = -40^{\circ}\text{C}$ to $+125^{\circ}\text{C}$	16	50	81	Gauss	Direct
			$T_A = -40^{\circ}\text{C}$ to $+150^{\circ}\text{C}$	15	50	88		
	Brp	Release Point	$T_A = -40^{\circ}\text{C}$ to $+125^{\circ}\text{C}$	-81	-50	-16		
			$T_A = -40^{\circ}\text{C}$ to $+150^{\circ}\text{C}$	-88	-50	-15		
	B <sub>HY</sub>	Hysteresis (Note 13)	$T_A = -40^{\circ}\text{C}$ to $+125^{\circ}\text{C}$	60	100	—		
			$T_A = -40^{\circ}\text{C}$ to $+150^{\circ}\text{C}$	50	100	—		
AH1714Q	Bop	Operation Point	$T_A = -40^{\circ}\text{C}$ to $+125^{\circ}\text{C}$	5	18	37	Gauss	Inverted
			$T_A = -40^{\circ}\text{C}$ to $+150^{\circ}\text{C}$	2	18	45		
	Brp	Release Point	$T_A = -40^{\circ}\text{C}$ to $+125^{\circ}\text{C}$	-37	-18	-5		
			$T_A = -40^{\circ}\text{C}$ to $+150^{\circ}\text{C}$	-45	-18	-2		
	B <sub>HY</sub>	Hysteresis (Note 13)	$T_A = -40^{\circ}\text{C}$ to $+125^{\circ}\text{C}$	23	36	—		
			$T_A = -40^{\circ}\text{C}$ to $+150^{\circ}\text{C}$	17.5	36	—		

- Notes:
- When power is initially turned on,  $V_{DD}$  must be within its correct operating range (2.4V to 5.5V) to guarantee the output sampling. The output state is valid after the startup time of 38 $\mu\text{s}$  typical from the operating voltage reaching 2.4V.
  - Typical values are defined at  $T_A = +25^{\circ}\text{C}$ . Maximum and minimum values over the operating temperature range is not tested in production but guaranteed by design, process control and characterization.
  - Maximum and minimum hysteresis is guaranteed by design, process control and characterization.

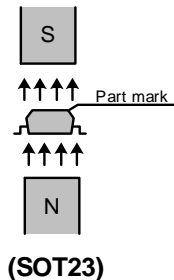
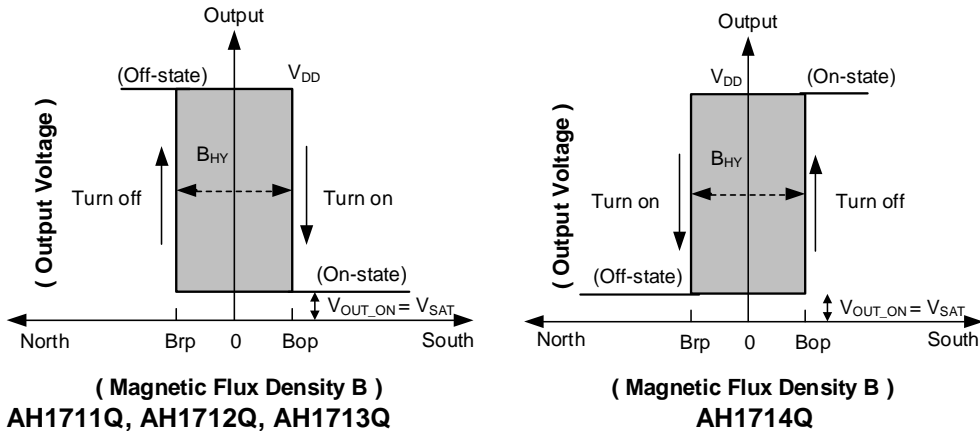

**Typical Operating Characteristics**

**Supply Current**

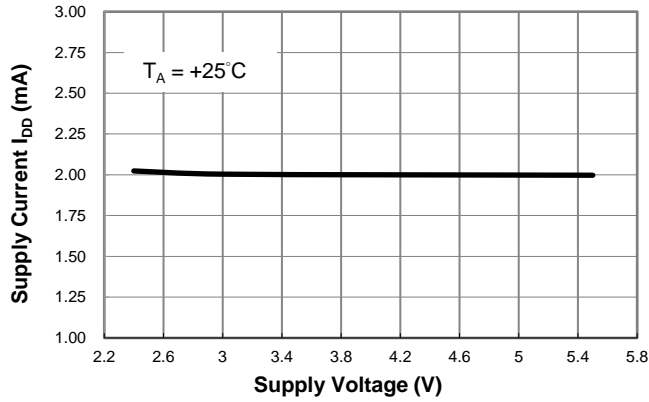

Operation Current vs. Supply Voltage

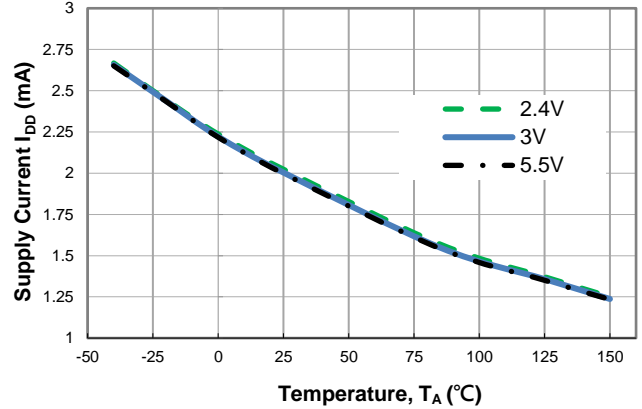

Operation Current vs. Temperature

**Low-Level Output Voltage,  $I_{OUT} = 20\text{mA}$**

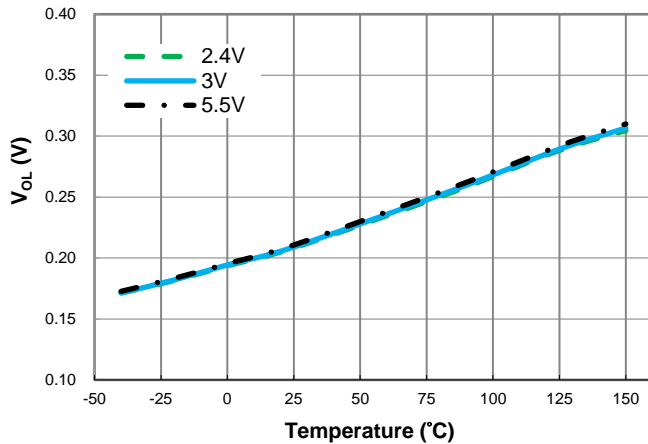

Output Voltage  $V_{OL}$  vs. Temperature

**Output Leakage Current**

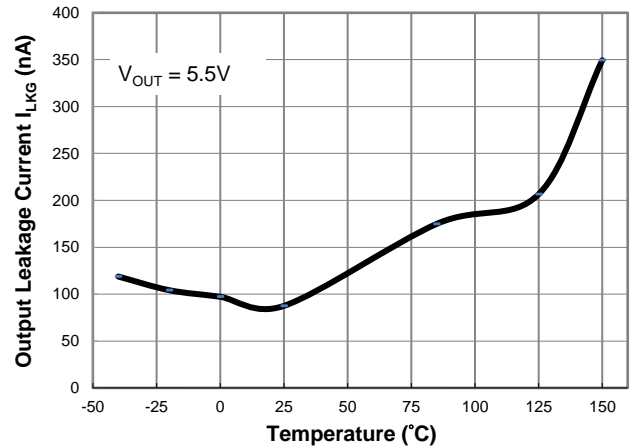

Output Leakage Current vs. Temperature

**Output Rising/Falling Time**

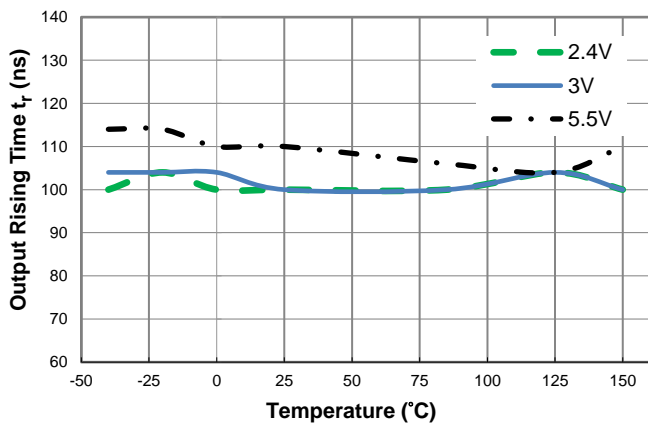

Output Rising Time ( $t_r$ ) vs. Temperature

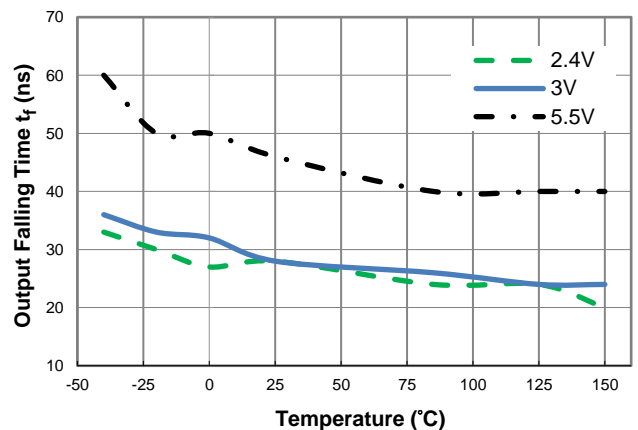

Output Falling Time ( $t_f$ ) vs. Temperature

Typical Operating Characteristics (continued)

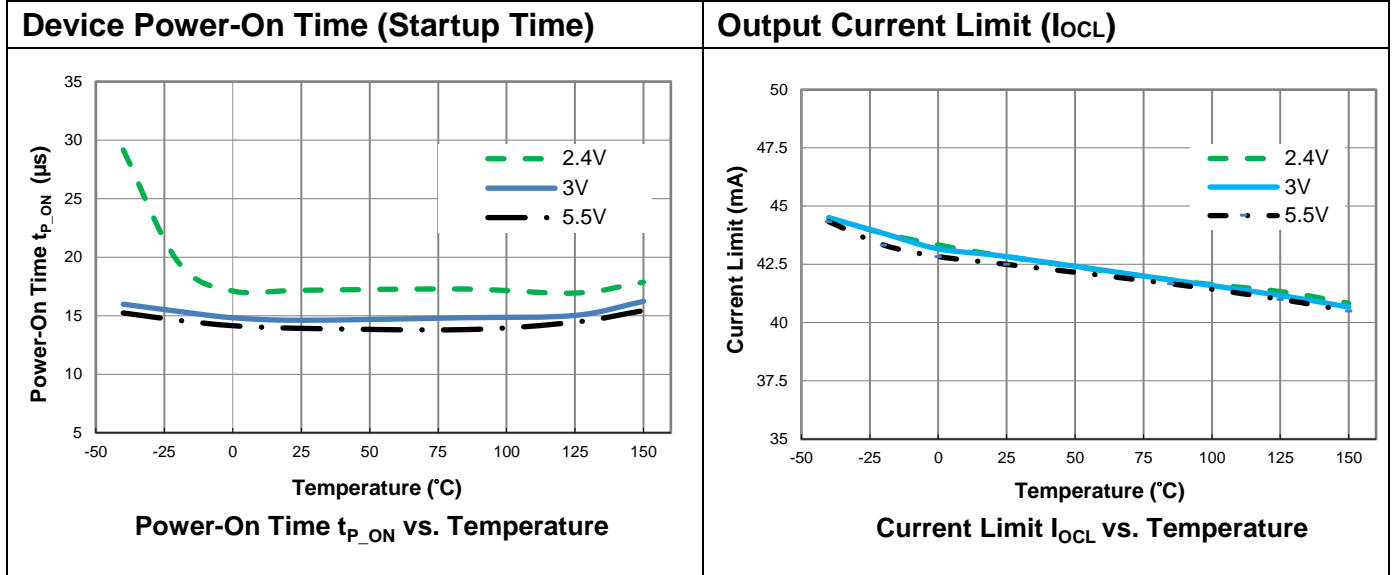

**AH1711Q - Switch Point  $B_{OP}/B_{RP}$  and Hysteresis  $B_{HY}$**

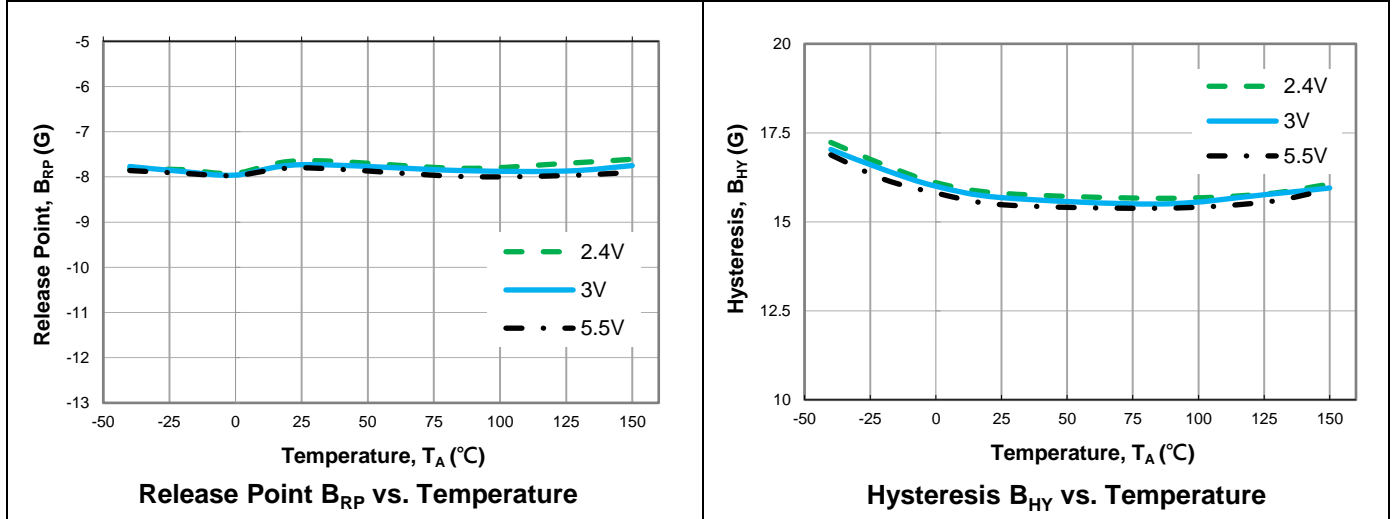
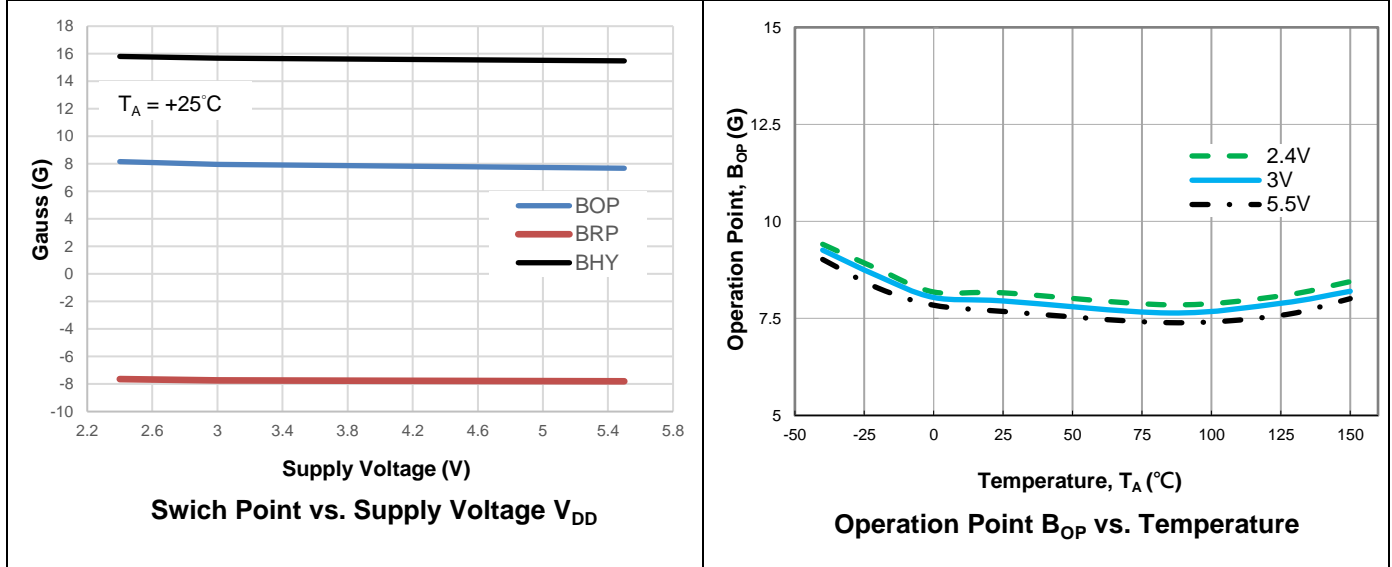

Typical Operating Characteristics (continued)

AH1712Q/AH1714Q - Switch Point  $B_{OP}/B_{RP}$  and Hysteresis  $B_{HY}$

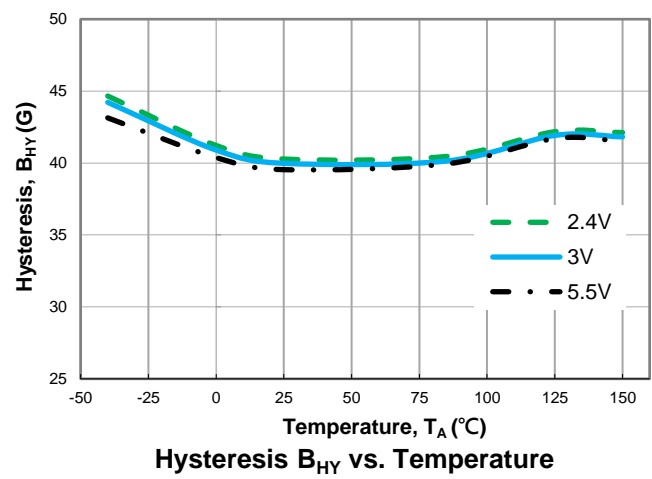
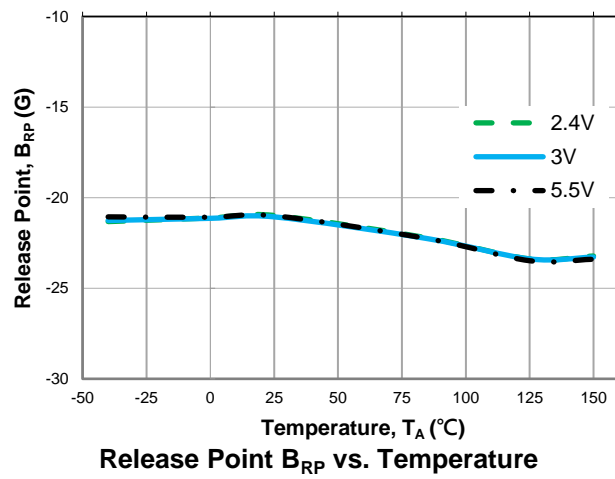
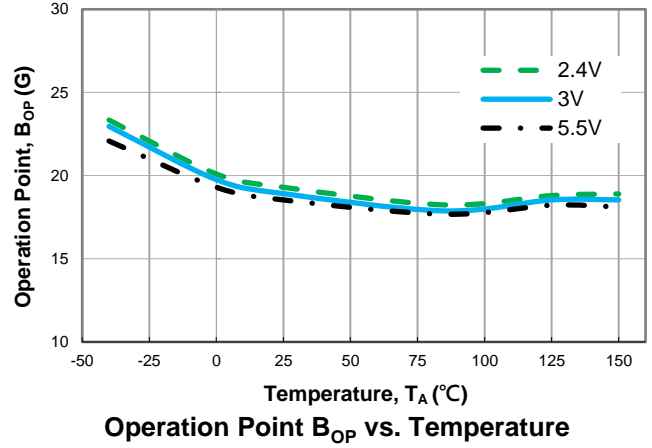
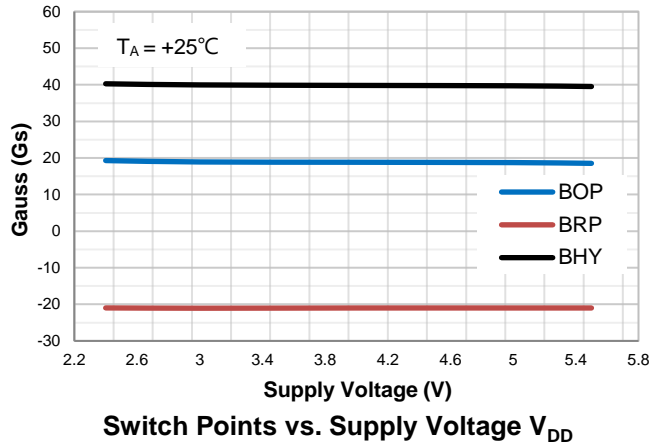

Typical Operating Characteristics (continued)

AH1713Q - Switch Point B<sub>OP</sub>/B<sub>RP</sub> and Hysteresis B<sub>HY</sub>

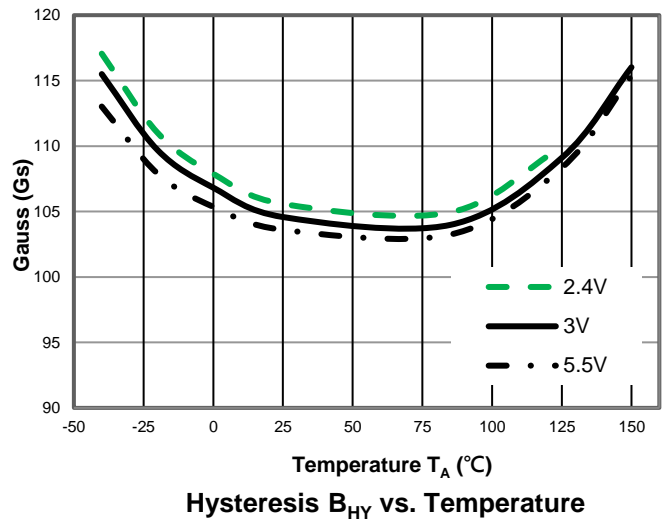
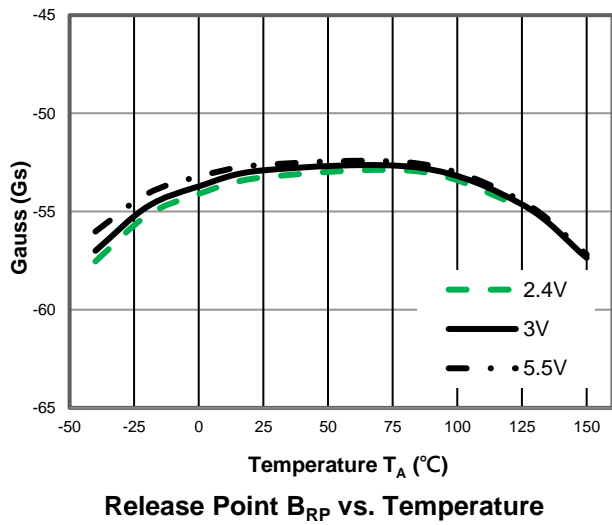
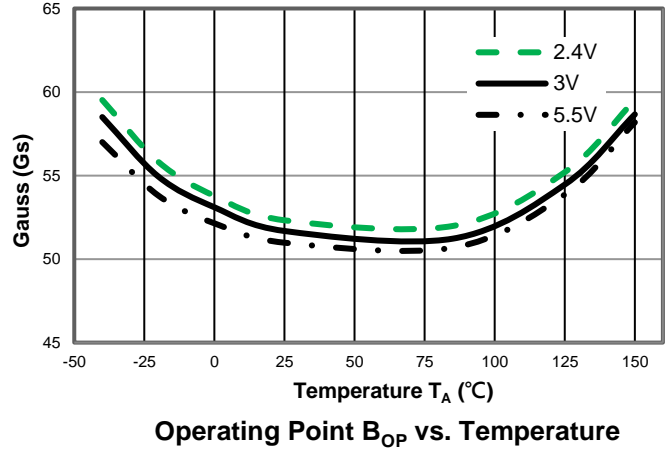
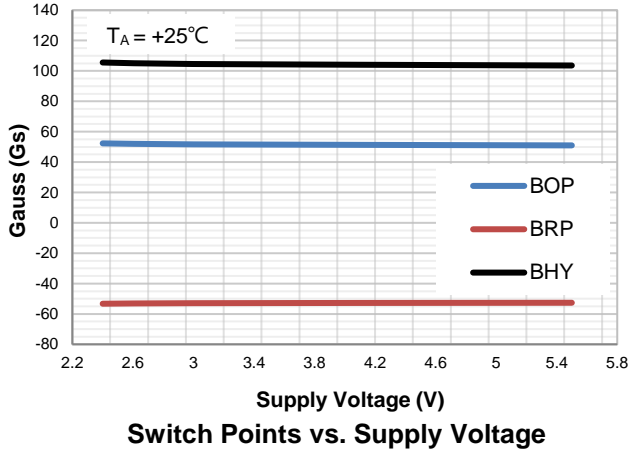



**Application Information**

**Power-On State (POS)**

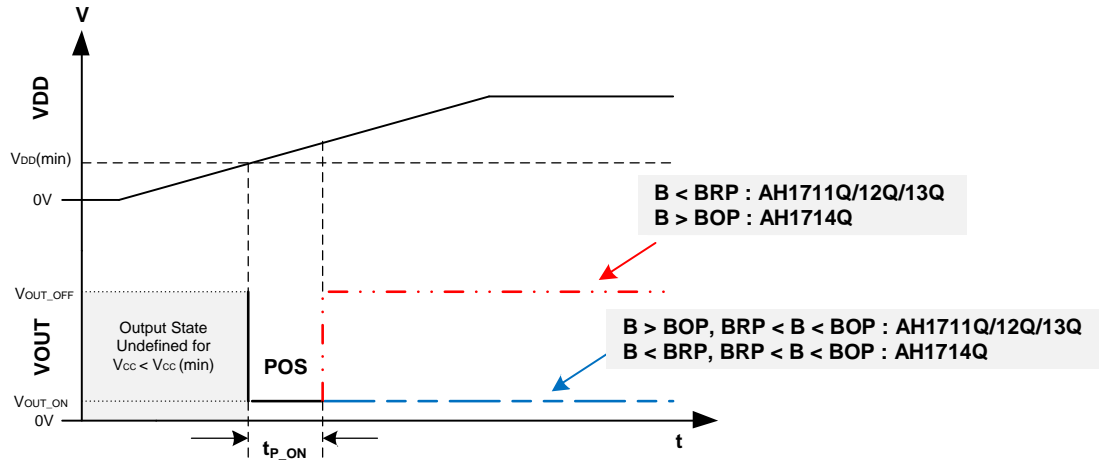

**Thermal Performance Characteristics**

Package : SOT23

T <sub>A</sub> (°C)	25	50	60	70	80	85	90	100	105	110	120	125	130	140	150
P <sub>D</sub> (mW)	230	184	166	147	129	120	110	92	83	74	55	46	37	18	0

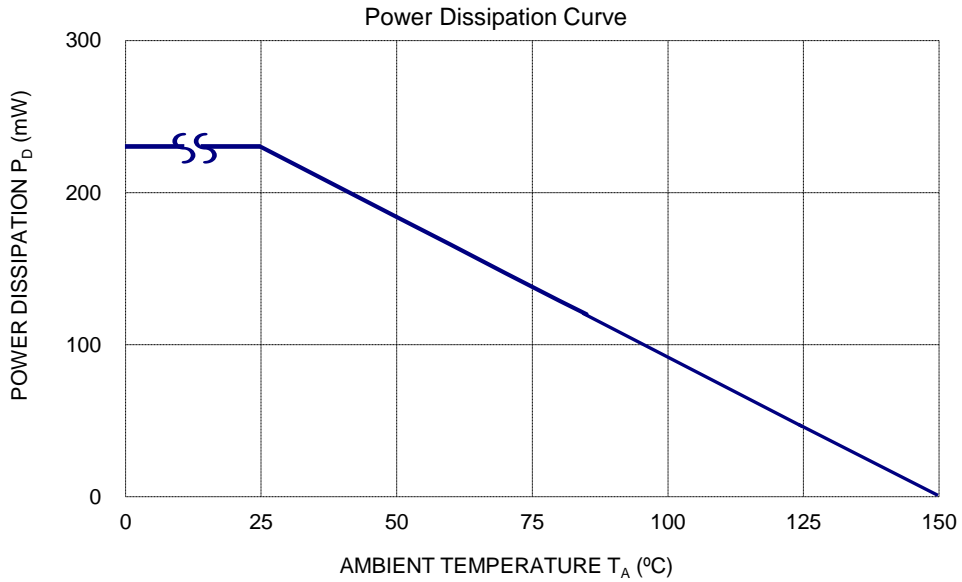

## Ordering Information

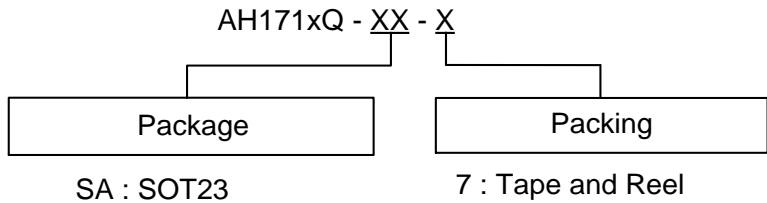

Part Number	Part Number Suffix	Package Code	Package	Packing	
				Qty.	Carrier
AH1711Q-SA-7	-7	SA	SOT23	3,000	7" Tape and Reel
AH1712Q-SA-7	-7	SA	SOT23	3,000	7" Tape and Reel
AH1713Q-SA-7	-7	SA	SOT23	3,000	7" Tape and Reel
AH1714Q-SA-7	-7	SA	SOT23	3,000	7" Tape and Reel

## Marking Information

Package Type: SOT23

( Top View )

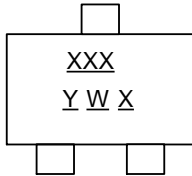

XXX : Identification Code  
Y : Year 0 to 9 (ex: 3 = 2023)  
W : Week : A to Z : week 1 to 26;  
a to z : week 27 to 52; z represents week 52 and 53  
X : Internal Code

Part Number	Package	Identification Code
AH1711Q-SA-7	SOT23	XKQ
AH1712Q-SA-7	SOT23	XMQ
AH1713Q-SA-7	SOT23	XNQ
AH1714Q-SA-7	SOT23	XPQ

**Package Outline Dimensions**

Please see <http://www.diodes.com/package-outlines.html> for the latest version.

**SOT23**

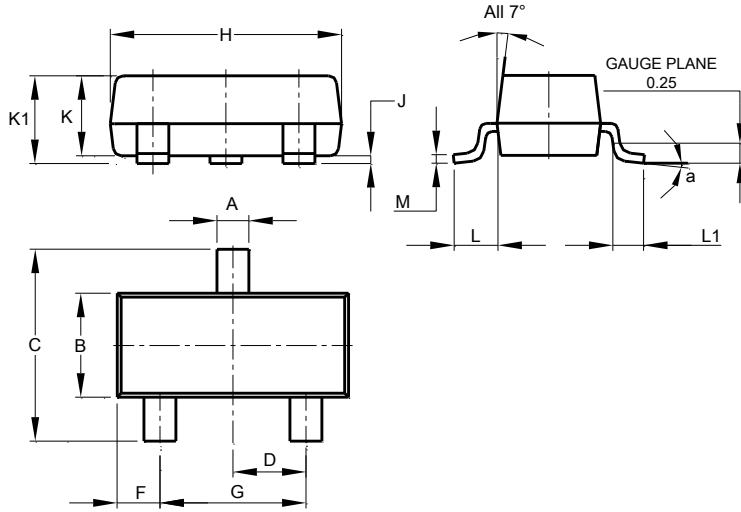

SOT23			
Dim	Min	Max	Typ
A	0.37	0.51	0.40
B	1.20	1.40	1.30
C	2.30	2.50	2.40
D	0.89	1.03	0.915
F	0.45	0.60	0.535
G	1.78	2.05	1.83
H	2.80	3.00	2.90
J	0.013	0.10	0.05
K	0.890	1.00	0.975
K1	0.903	1.10	1.025
L	0.45	0.61	0.55
L1	0.25	0.55	0.40
M	0.085	0.150	0.110
a	0°	8°	--
All Dimensions in mm			

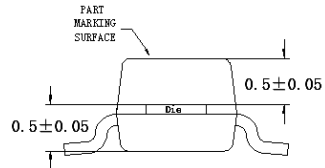
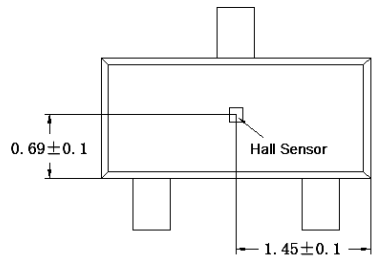

**Sensor Location**

## Suggested Pad Layout

Please see <http://www.diodes.com/package-outlines.html> for the latest version.

### SOT23

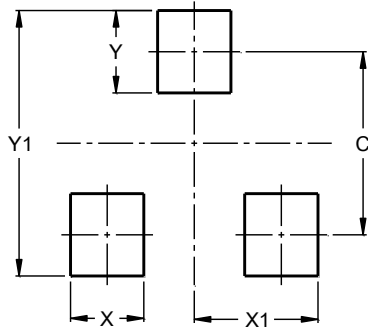

Dimensions	Value (in mm)
C	2.0
X	0.8
X1	1.35
Y	0.9
Y1	2.9

## Mechanical Data

- Moisture Sensitivity: Level 1 per J-STD-020
- Terminals: Finish – Matte Tin Plated Leads, Solderable per MIL-STD-202, Method 208 (E3)
- Weight: 0.009 grams (Approximate)

**IMPORTANT NOTICE**

1. DIODES INCORPORATED (Diodes) AND ITS SUBSIDIARIES MAKE NO WARRANTY OF ANY KIND, EXPRESS OR IMPLIED, WITH REGARDS TO ANY INFORMATION CONTAINED IN THIS DOCUMENT, INCLUDING, BUT NOT LIMITED TO, THE IMPLIED WARRANTIES OF MERCHANTABILITY, FITNESS FOR A PARTICULAR PURPOSE OR NON-INFRINGEMENT OF THIRD PARTY INTELLECTUAL PROPERTY RIGHTS (AND THEIR EQUIVALENTS UNDER THE LAWS OF ANY JURISDICTION).
2. The Information contained herein is for informational purpose only and is provided only to illustrate the operation of Diodes' products described herein and application examples. Diodes does not assume any liability arising out of the application or use of this document or any product described herein. This document is intended for skilled and technically trained engineering customers and users who design with Diodes' products. Diodes' products may be used to facilitate safety-related applications; however, in all instances customers and users are responsible for (a) selecting the appropriate Diodes products for their applications, (b) evaluating the suitability of Diodes' products for their intended applications, (c) ensuring their applications, which incorporate Diodes' products, comply the applicable legal and regulatory requirements as well as safety and functional-safety related standards, and (d) ensuring they design with appropriate safeguards (including testing, validation, quality control techniques, redundancy, malfunction prevention, and appropriate treatment for aging degradation) to minimize the risks associated with their applications.
3. Diodes assumes no liability for any application-related information, support, assistance or feedback that may be provided by Diodes from time to time. Any customer or user of this document or products described herein will assume all risks and liabilities associated with such use, and will hold Diodes and all companies whose products are represented herein or on Diodes' websites, harmless against all damages and liabilities.
4. Products described herein may be covered by one or more United States, international or foreign patents and pending patent applications. Product names and markings noted herein may also be covered by one or more United States, international or foreign trademarks and trademark applications. Diodes does not convey any license under any of its intellectual property rights or the rights of any third parties (including third parties whose products and services may be described in this document or on Diodes' website) under this document.
5. Diodes' products are provided subject to Diodes' Standard Terms and Conditions of Sale (<https://www.diodes.com/about/company/terms-and-conditions/terms-and-conditions-of-sales/>) or other applicable terms. This document does not alter or expand the applicable warranties provided by Diodes. Diodes does not warrant or accept any liability whatsoever in respect of any products purchased through unauthorized sales channel.
6. Diodes' products and technology may not be used for or incorporated into any products or systems whose manufacture, use or sale is prohibited under any applicable laws and regulations. Should customers or users use Diodes' products in contravention of any applicable laws or regulations, or for any unintended or unauthorized application, customers and users will (a) be solely responsible for any damages, losses or penalties arising in connection therewith or as a result thereof, and (b) indemnify and hold Diodes and its representatives and agents harmless against any and all claims, damages, expenses, and attorney fees arising out of, directly or indirectly, any claim relating to any noncompliance with the applicable laws and regulations, as well as any unintended or unauthorized application.
7. While efforts have been made to ensure the information contained in this document is accurate, complete and current, it may contain technical inaccuracies, omissions and typographical errors. Diodes does not warrant that information contained in this document is error-free and Diodes is under no obligation to update or otherwise correct this information. Notwithstanding the foregoing, Diodes reserves the right to make modifications, enhancements, improvements, corrections or other changes without further notice to this document and any product described herein. This document is written in English but may be translated into multiple languages for reference. Only the English version of this document is the final and determinative format released by Diodes.
8. Any unauthorized copying, modification, distribution, transmission, display or other use of this document (or any portion hereof) is prohibited. Diodes assumes no responsibility for any losses incurred by the customers or users or any third parties arising from any such unauthorized use.
9. This Notice may be periodically updated with the most recent version available at <https://www.diodes.com/about/company/terms-and-conditions/important-notice>

The Diodes logo is a registered trademark of Diodes Incorporated in the United States and other countries.  
All other trademarks are the property of their respective owners.  
© 2023 Diodes Incorporated. All Rights Reserved.

[www.diodes.com](http://www.diodes.com)