



## Description

The AH3366Q is an AECQ100 qualified high-voltage medium sensitivity Hall Effect Unipolar switch IC designed for position and proximity sensing in automotive applications such as in seat and seatbelt buckle, steering lock/immobilisation, gear stick, transmission actuator and gear position, HVAC compression, wiper, door/trunk closure, etc. To support wide range of demanding applications, the design has been optimized to operate over the supply range of 3.0V to 28V. With chopper stabilized architecture and an internal bandgap regulator to provide temperature compensated supply for internal circuits, the AH3366Q provides a reliable solution over the whole operating range. For robustness and protection, the device has a reverse blocking diode with a Zener clamp on the supply. The output has an over current limit and a Zener clamp.

The single open drain output can be switched on with South pole of sufficient strength. When the magnetic flux density (B) perpendicular to the package is larger than the operate point (B<sub>OP</sub>) the output is switched on (pulled low) and is held on until magnetic flux density B is lower than the release point (B<sub>RP</sub>). The output remains switched off for North pole fields to or no magnetic fields.

The magnetic operating and release polarity is opposite for SOT23 and SC59 packages. The SOT23, SIP-3 (Ammo Pack) and SIP-3 (Bulk Pack) packages require south pole to the part marking side to operate while SC59 requires south pole to the non-part marking side.

## Features

- Unipolar Operation
- Medium Sensitivity: B<sub>OP</sub> and B<sub>RP</sub> of 100G and 85G typical
- Single Open Drain Output with Over Current Limit
- 3.0V to 28V Operating Voltage Range
- Chopper Stabilized Design Provides
  - Superior Temperature Stability
  - Minimal Switch Point Drift
  - Enhanced Immunity to Stress
- Good RF Noise Immunity
- Reverse Blocking Diode
- Zener Clamp on Supply and Output Pins
- -40°C to +150°C Operating Temperature
- ESD: HBM > 8kV, CDM > 2kV
- AECQ100 Grade 0 Qualified
- Industry Standard SC59, SOT23 and SIP-3 (Ammo Pack), SIP-3 (Bulk Pack) Packages
- **Totally Lead-Free & Fully RoHS Compliant (Notes 1 & 2)**
- **Halogen and Antimony Free. "Green" Device (Note 3)**
- **The AH3366Q is suitable for automotive applications requiring specific change control; this part is AEC-Q100 qualified, PPAP capable, and manufactured in IATF 16949 certified facilities.**  
<https://www.diodes.com/quality/product-definitions/>

## Pin Assignments

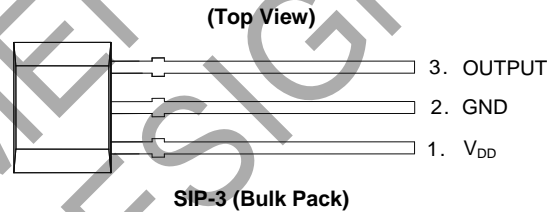
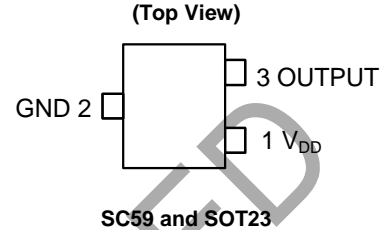

## Applications

- Position and proximity sensing in automotive applications
- Seat positions
- Seatbelt buckles
- Steering locks/immobilisations
- Gear sticks
- HVAC compressions
- Transmission actuators
- Transmission gear positions
- Wipers
- Sunroofs and windows
- Door/Trunk closures
- Door locks
- Contact-Less switches

Notes:

1. No purposely added lead. Fully EU Directive 2002/95/EC (RoHS) & 2011/65/EU (RoHS 2) compliant.
2. See [http://www.diodes.com/quality/lead\\_free.html](http://www.diodes.com/quality/lead_free.html) for more information about Diodes Incorporated's definitions of Halogen- and Antimony-free, "Green" and Lead-free.
3. Halogen- and Antimony-free "Green" products are defined as those which contain <900ppm bromine, <900ppm chlorine (<1500ppm total Br + Cl) and <1000ppm antimony compounds.

**Typical Applications Circuit** (Note 4)

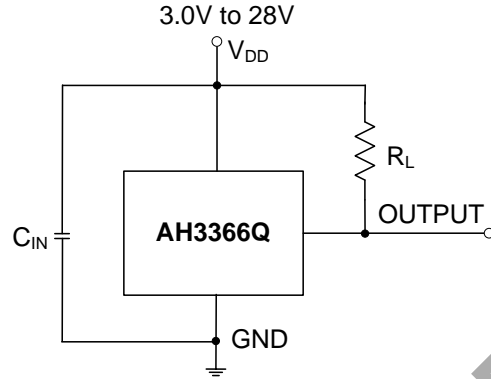

Note: 4.  $C_{IN}$  is for power stabilization and to strengthen the noise immunity, the recommended capacitance is 10nF ~ 100nF.  
 $R_L$  is the pull-up resistor.

**Pin Descriptions**

Package: SC59, SOT23, SIP-3 (Ammo Pack) and SIP-3 (Bulk Pack)

Pin Number	Pin Name	Function
1	V <sub>DD</sub>	Power Supply Input
2	GND	Ground
3	OUTPUT	Output Pin

**Functional Block Diagram**

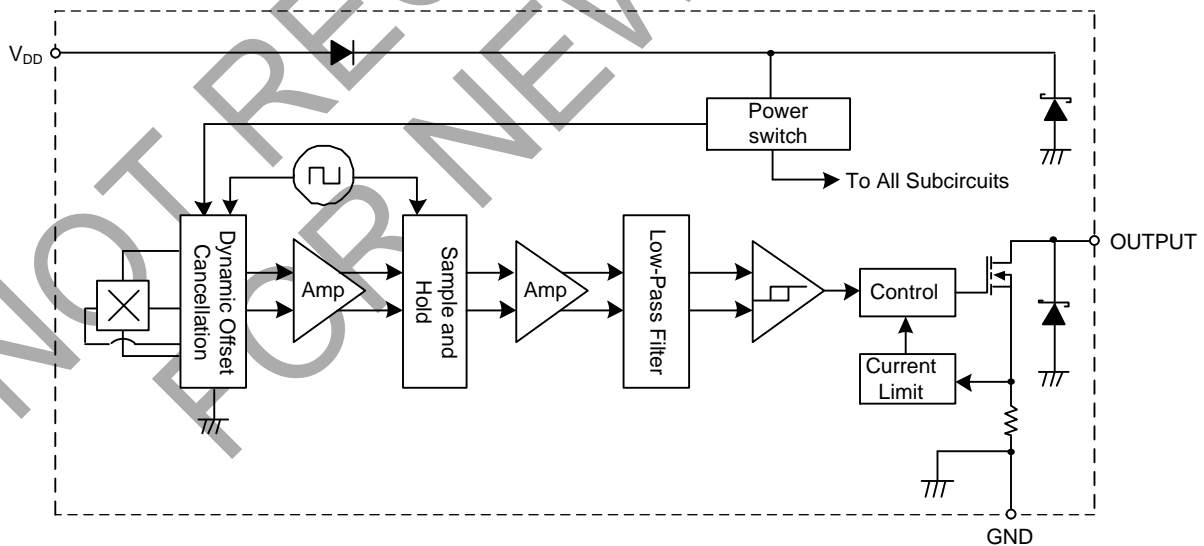

### Absolute Maximum Ratings (Notes 5 & 6) (@T<sub>A</sub> = +25°C, unless otherwise specified.)

Symbol	Characteristic	Value	Unit	
V <sub>DD</sub>	Supply Voltage (Note 6)	32	V	
V <sub>DDR</sub>	Reverse Supply Voltage (Note 6)	-32	V	
V <sub>OUT_MAX</sub>	Output Off Voltage (Note 6)	32	V	
I <sub>OUT</sub>	Continuous Output Current	60	mA	
I <sub>OUT_R</sub>	Reverse Output Current	-50	mA	
B	Magnetic Flux Density	Unlimited		
P <sub>D</sub>	Package Power Dissipation	SIP-3 (Ammo Pack), SIP-3 (Bulk Pack)	550	mW
		SC59 and SOT23	230	
T <sub>s</sub>	Storage Temperature Range	-65 to +165	°C	
T <sub>J</sub>	Maximum Junction Temperature	+150	°C	
ESD HBM	Electros Static Discharge Withstand - Human Body Model (HBM)	8	kV	
ESD MM	Electros Static Discharge Withstand - Machine Model (MM)	800	V	
ESD CDM	Electros Static Discharge Withstand - Charged Device Model (CDM)	2	kV	

- Notes:
- Stresses greater than the 'Absolute Maximum Ratings' specified above can cause permanent damage to the device. These are stress ratings only; functional operation of the device at these or any other conditions exceeding those indicated in this specification is not implied. Device reliability can be affected by exposure to absolute maximum rating conditions for extended periods of time.
  - The absolute maximum V<sub>DD</sub> of 32V is a transient stress rating and is not meant as a functional operating condition. It is not recommended to operate the device at the absolute maximum rated conditions for any period of time.

### Recommended Operating Conditions (@T<sub>A</sub> = -40°C to +150°C, unless otherwise specified.)

Symbol	Parameter	Condition	Rating	Unit
V <sub>DD</sub>	Supply Voltage	Operating	3.0 to 28	V
T <sub>A</sub>	Operating Temperature Range	Operating	-40 to +150	°C

### Electrical Characteristics (Notes 7 & 8) (@T<sub>A</sub> = -40°C to +150°C, V<sub>DD</sub> = 3V to 28V, unless otherwise specified.)

Symbol	Parameter	Condition	Min	Typ	Max	Unit
V <sub>OUT_ON</sub>	Output ON Voltage	I <sub>OUT</sub> = 20mA, B > Bop	—	0.2	0.4	V
I <sub>LKG</sub>	Output Leakage Current (When output is off)	V <sub>OUT</sub> = 28V, B < Brp, Output off	—	<0.1	10	µA
I <sub>DD</sub>	Supply Current	Output open, T <sub>A</sub> = +25°C	—	3	3.5	mA
		Output open, T <sub>A</sub> = -40°C to +150°C	—	—	4	mA
I <sub>DD_R</sub>	Reverse Supply Current	V <sub>DD</sub> = -18V, T <sub>A</sub> = +25°C	—	0.6	—	µA
		V <sub>DD</sub> = -18V, T <sub>A</sub> = -40°C to +150°C	—	0.6	1500	µA
		V <sub>DD</sub> = -28V, T <sub>A</sub> = +25°C	—	1.6	—	µA
		V <sub>DD</sub> = -28V, T <sub>A</sub> = -40°C to +150°C	—	1.6	2500	µA
t <sub>P_ON</sub>	Device Power-On Time (Start-up time)	V <sub>DD</sub> ≥ 3V, B > Bop (Note 7)	—	10	—	µs
f <sub>C</sub>	Chopping Frequency	—	—	800	—	kHz
t <sub>D</sub>	Response Time Delay (Time from magnetic threshold reached to the start of the output rise or fall)	(Note 9)	—	3.75	—	µs
t <sub>R</sub>	Output Rising Time (External pull-up resistor R <sub>L</sub> and load capacitance dependent)	R <sub>L</sub> = 1kΩ, C <sub>L</sub> = 20pF	—	0.2	1	µs
t <sub>F</sub>	Output Falling Time (Internal switch resistance and load capacitance dependent)	R <sub>L</sub> = 1kΩ, C <sub>L</sub> = 20pF	—	0.1	1	µs
I <sub>OCL</sub>	Output Current Limit	B > Bop (Note 10)	30	—	55	mA
V <sub>Z</sub>	Zener Clamp Voltage	I <sub>DD</sub> = 5mA	28	—	—	V

- Notes:
- When power is initially turned on, V<sub>DD</sub> must be within its correct operating range (3.0V to 28V) to guarantee the output sampling. The output state is valid after the start-up time of 10µs typical from the operating voltage reaching 3V.
  - Typical values are defined at T<sub>A</sub> = +25°C, V<sub>DD</sub> = 12V. Maximum and minimum values over the operating temperature range is not tested in production but guaranteed by design, process control and characterization.
  - Guaranteed by design, process control and characterization. Not tested in production.
  - The device will limit the output current I<sub>OUT</sub> to current limit of I<sub>OCL</sub>.

**Magnetic Characteristics** (Notes 11 & 12) ( $T_A = -40^\circ\text{C}$  to  $+150^\circ\text{C}$ ,  $V_{DD} = 3.0\text{V}$  to  $28\text{V}$ , unless otherwise specified.)

(1mT = 10 Gauss)

Symbol	Parameter	Conditions	Min	Typ	Max	Unit
B <sub>Ops</sub> (South pole to the part marking side for SOT23 and SIP-3 (Ammo Pack), SIP-3 (Bulk Pack) packages; South pole to the non-part marking side for SC59 package. See diagram below)	Operation Point	$V_{DD} = 12\text{V}$ , $T_A = +25^\circ\text{C}$	—	100	—	Gauss
		$T_A = -40^\circ\text{C}$ to $+150^\circ\text{C}$	65	100	135	
B <sub>Rps</sub> (South pole to the part marking side for SOT23 and SIP-3 (Ammo Pack), SIP-3 (Bulk Pack) packages; South pole to the non-part marking side for SC59 package. See diagram below)	Release Point	$V_{DD} = 12\text{V}$ , $T_A = +25^\circ\text{C}$	—	85	—	Gauss
		$T_A = -40^\circ\text{C}$ to $+150^\circ\text{C}$	50	85	120	
B <sub>HY</sub> ( B <sub>OPX</sub>   -  B <sub>RPX</sub>  )	Hysteresis (Note 13)	$V_{DD} = 12\text{V}$ , $T_A = +25^\circ\text{C}$	—	15	—	Gauss
		$T_A = -40^\circ\text{C}$ to $+150^\circ\text{C}$	8	15	25	

- Notes:
- When power is initially turned on,  $V_{DD}$  must be within its correct operating range (3.0V to 28V) to guarantee the output sampling. The output state is valid after the start-up time of 10μs typical from the operating voltage reaching 3V.
  - Typical values are defined at  $T_A = +25^\circ\text{C}$ ,  $V_{DD} = 12\text{V}$ . Maximum and minimum values over the operating temperature range is not tested in production but guaranteed by design, process control and characterization.
  - Maximum and minimum hysteresis is guaranteed by design, process control and characterization.

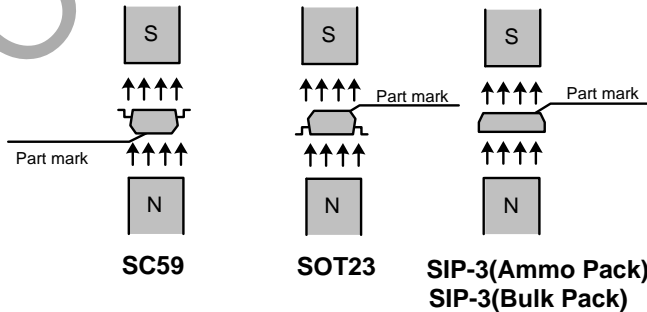
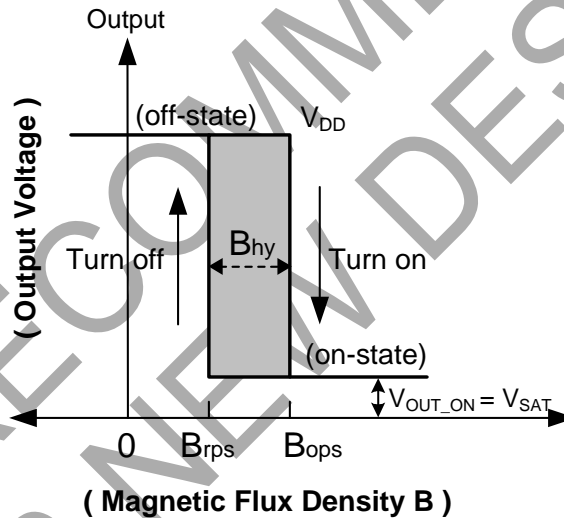

**Typical Operating Characteristics**

**Output Switch Operate and Release Points (Magnetic Thresholds) – B<sub>OPS</sub> and B<sub>RPS</sub>**

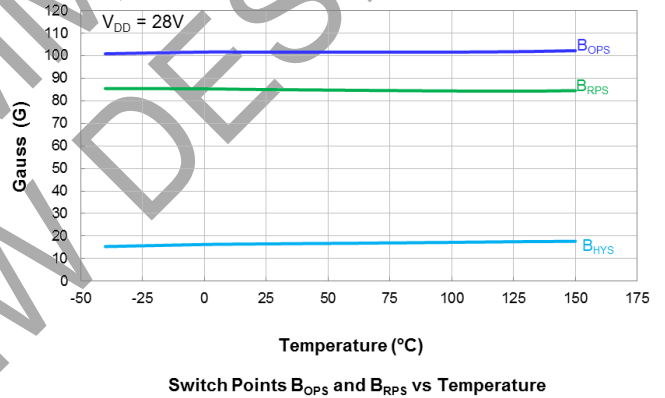
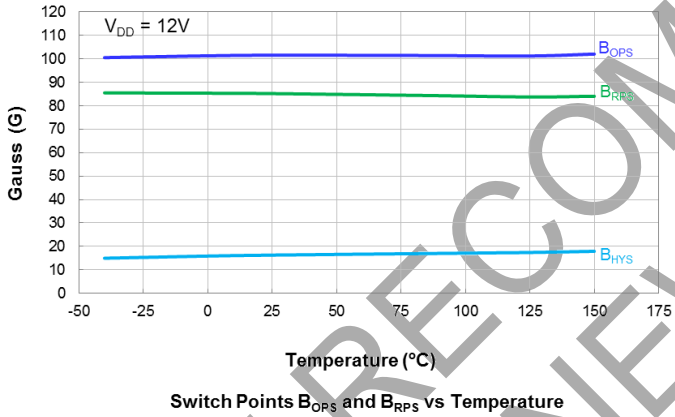
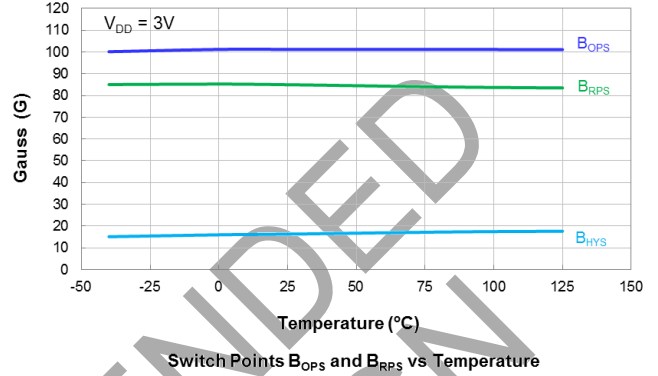
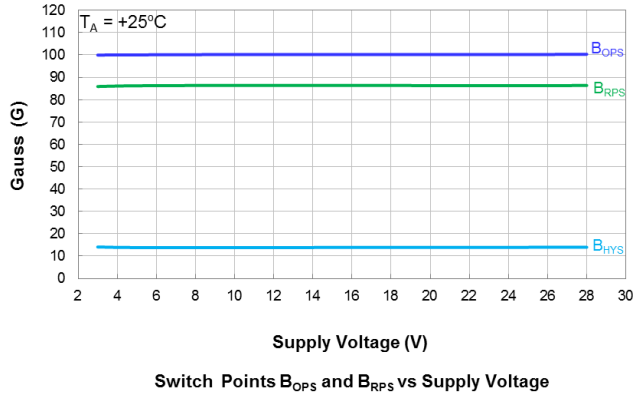

**Supply Current**

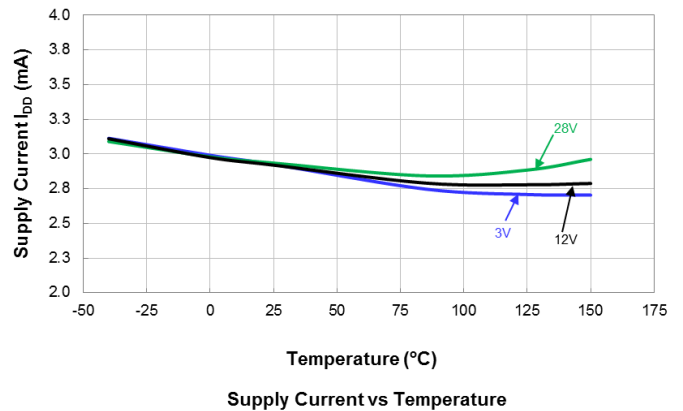
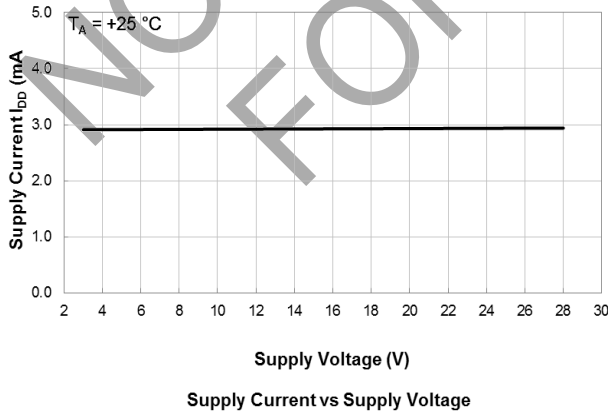

**Typical Operating Characteristics** (continued)

**Supply Reverse Current**

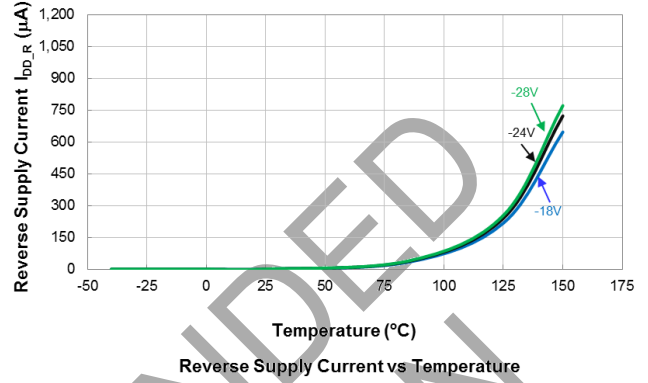
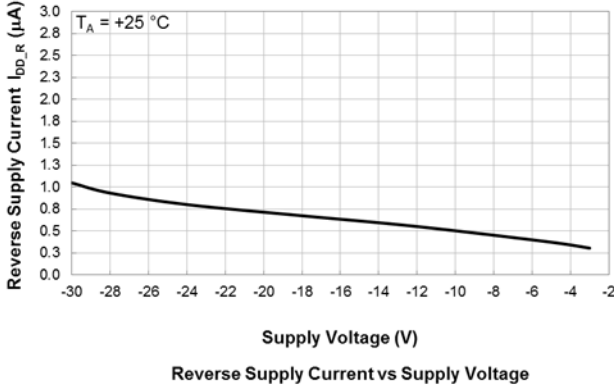

**Output Switch On Voltage**

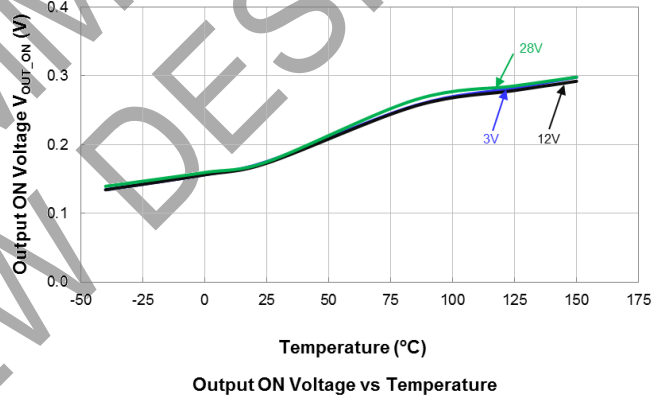
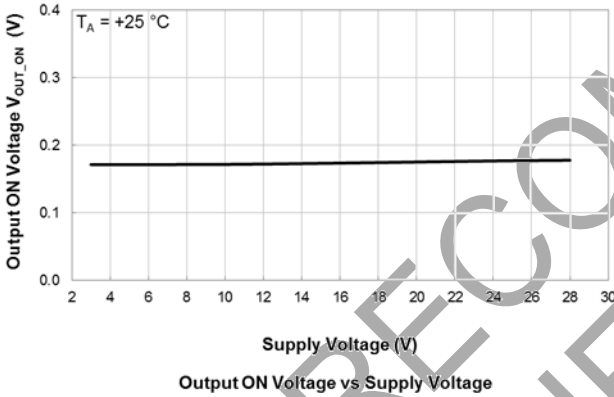

**Output Switch Leakage Current**

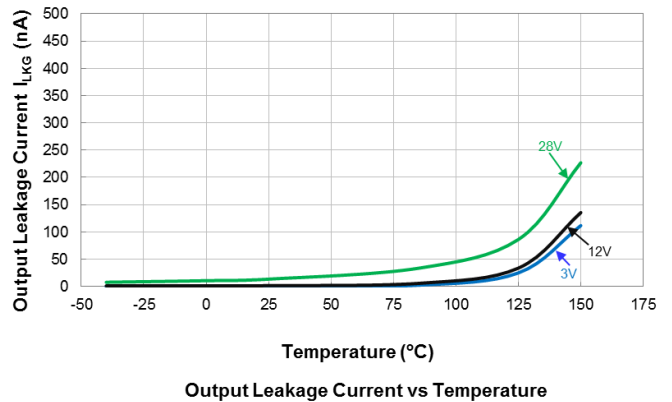
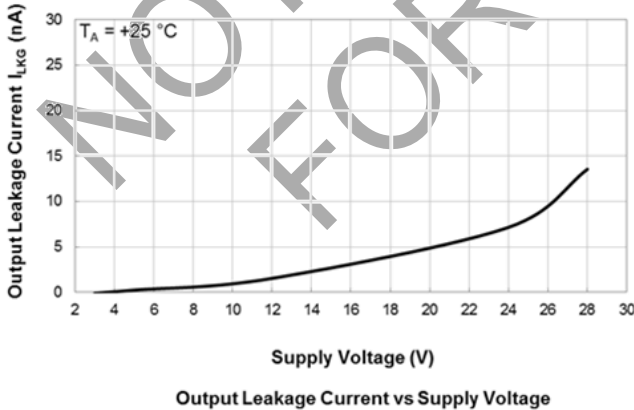

**Typical Operating Characteristics** (continued)

**Output Current Limit**

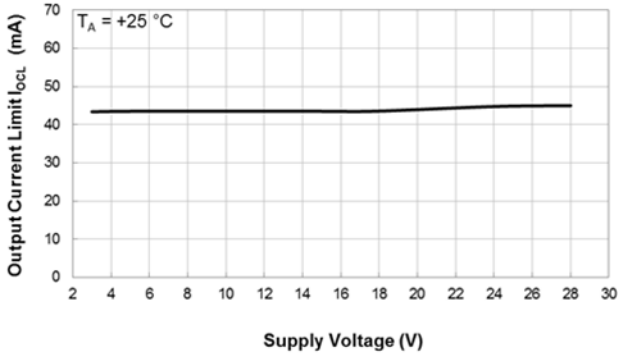

Output Current Limit vs Supply Voltage

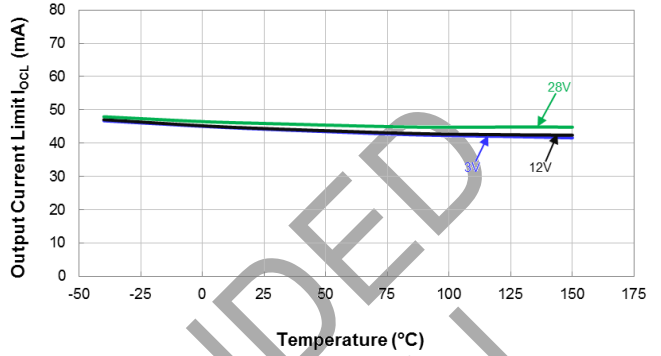

Output Current Limit vs Temperature

NOT RECOMMENDED FOR NEW DESIGN

**Thermal Performance Characteristics**

(1) Package type: SC59 and SOT23

T <sub>A</sub> (°C)	25	50	60	70	80	85	90	100	105	110	120	125	130	140	150
P <sub>D</sub> (mW)	230	184	166	147	129	120	110	92	83	74	55	46	37	18	0

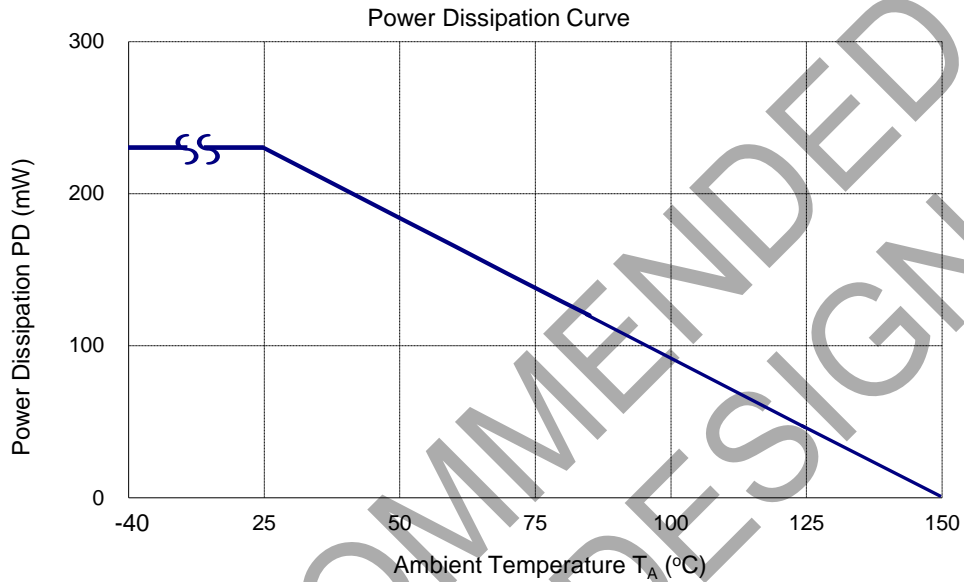

(2) Package type: SIP-3 (Ammo Pack), SIP-3 (Bulk Pack)

T <sub>A</sub> (°C)	25	50	60	70	80	85	90	100	105	110	120	125	130	140	150
P <sub>D</sub> (mW)	550	440	396	362	308	286	264	220	198	176	132	110	88	44	0

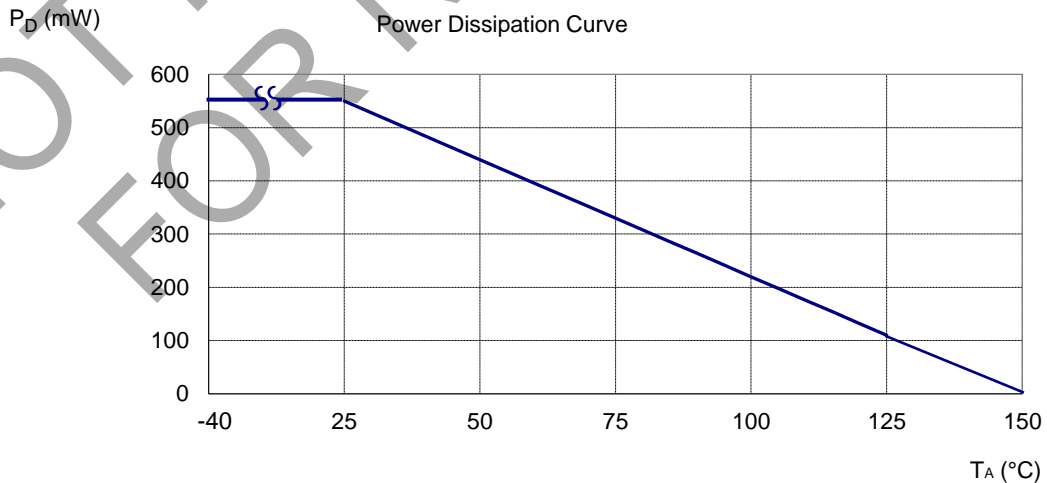



**Ordering Information**

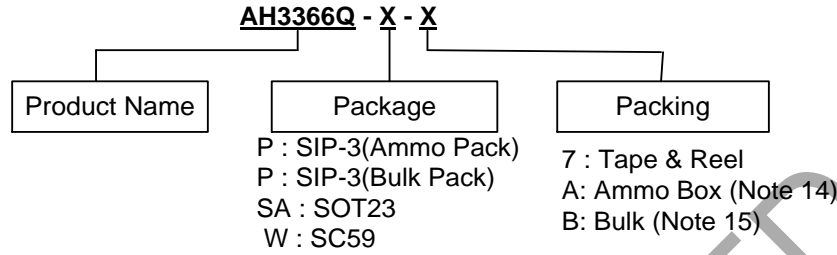

Part Number	Package Code	Package	Packing	
			Qty.	Carrier
AH3366Q-P-A	P	SIP-3 (Ammo Pack)	4000	Ammo Box
AH3366Q-P-B	P	SIP-3 (Bulk Pack)	1000	Bulk
AH3366Q-SA-7	SA	SOT23	3000	7" Tape & Reel
AH3366Q-W-7	W	SC59	3000	7" Tape & Reel

Notes: 14. Ammo Box is for SIP-3 (Ammo Pack) Spread Lead.  
15. Bulk is for SIP-3 (Bulk Pack) Straight Lead.

**Marking Information**

(1) Package Type: SC59 and SOT23

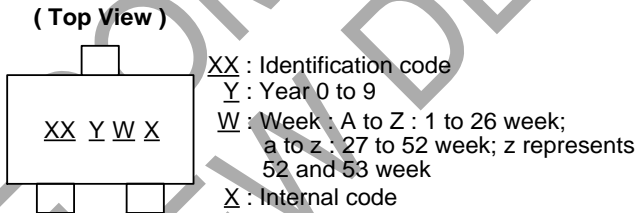

Part Number	Package	Identification Code
AH3366Q	SC59	DC
AH3366Q	SOT23	MJ

(2) Package Type: SIP-3 (Ammo Pack), SIP-3 (Bulk Pack)

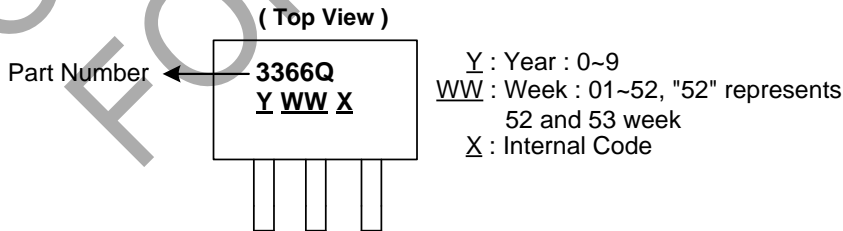

Part Number	Package	Identification Code
AH3366Q	SIP-3 (Ammo Pack)	3366Q
AH3366Q	SIP-3 (Bulk Pack)	3366Q

**Package Outline Dimensions**

Please see <http://www.diodes.com/package-outlines.html> for the latest version.

(1) Package Type: SC59

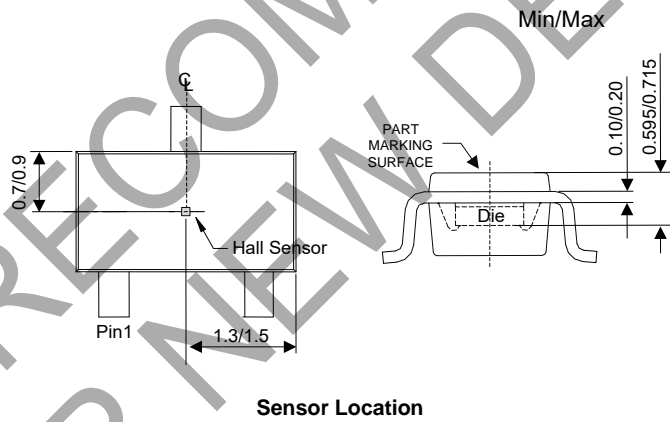
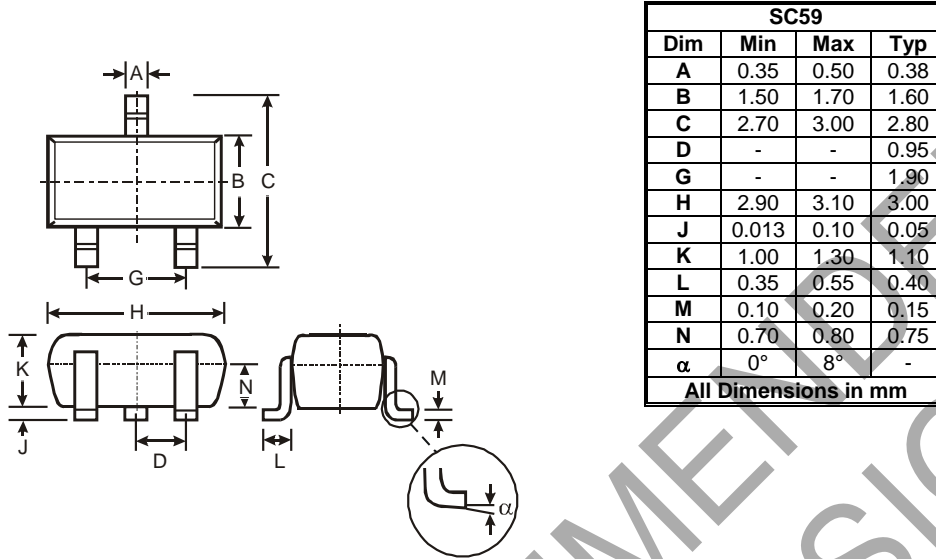

NOT RECOMMENDED FOR NEW DESIGN

**Package Outline Dimensions** (continued)

(2) Package Type: SOT23

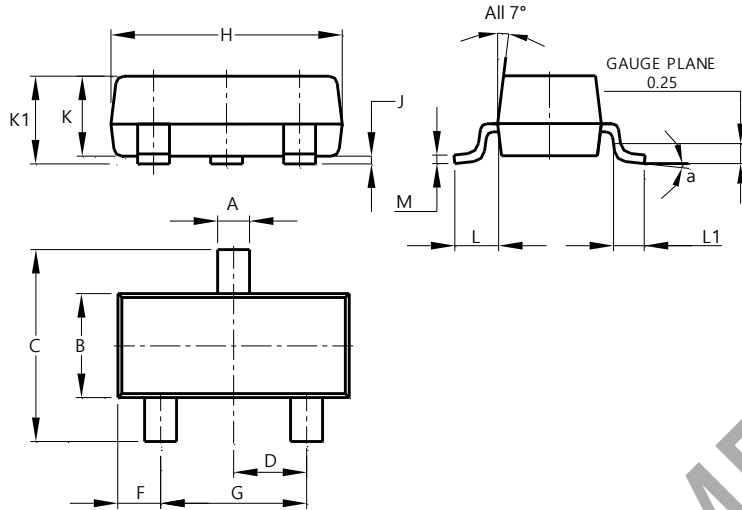

SOT23			
Dim	Min	Max	Typ
A	0.37	0.51	0.40
B	1.20	1.40	1.30
C	2.30	2.50	2.40
D	0.89	1.03	0.915
F	0.45	0.60	0.535
G	1.78	2.05	1.83
H	2.80	3.00	2.90
J	0.013	0.10	0.05
K	0.890	1.00	0.975
K1	0.903	1.10	1.025
L	0.45	0.61	0.55
L1	0.25	0.55	0.40
M	0.085	0.150	0.110
a	0°	8°	--
All Dimensions in mm			

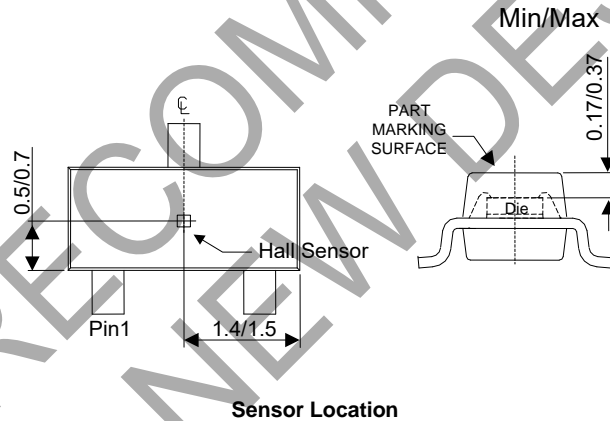

NOT RECOMMENDED FOR NEW DESIGN

**Package Outline Dimensions** (continued)

**(3) Package Type: SIP-3 (Bulk Pack)**

Sensor location to be added

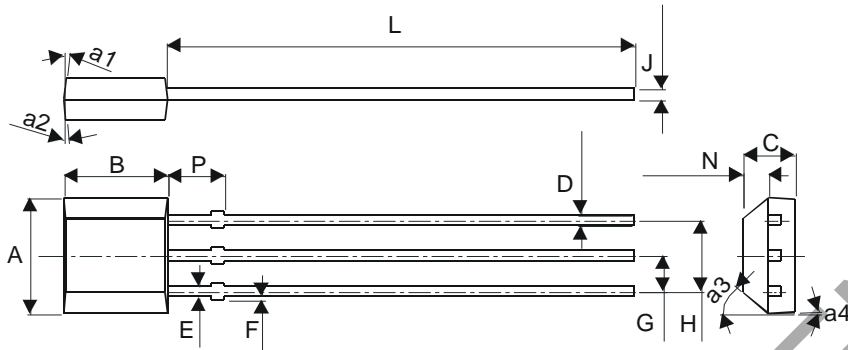

SIP-3 (Bulk Pack)		
Dim	Min	Max
A	3.9	4.3
a1	5° Typ	
a2	5° Typ	
a3	45° Typ	
a4	3° Typ	
B	2.8	3.2
C	1.40	1.60
D	0.33	0.432
E	0.40	0.508
F	0	0.2
G	1.24	1.30
H	2.51	2.57
J	0.35	0.43
L	14.0	15.0
N	0.63	0.84
P	1.55	-
All Dimensions in mm		

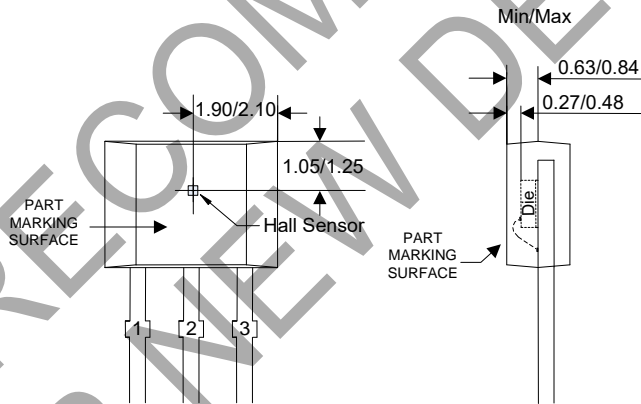

**Sensor Location**

**Package Outline Dimensions** (continued)

(4) Package Type: SIP-3 (Ammo Pack)

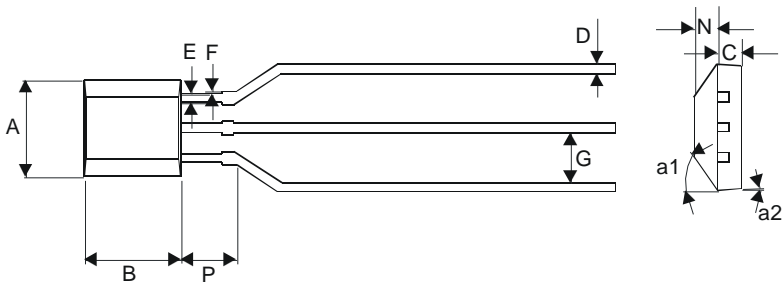

SIP-3 (Ammo Pack)		
Dim	Min	Max
A	3.9	4.3
a1	45° Typ	
a2	3° Typ	
B	2.8	3.2
C	1.40	1.60
D	0.35	0.41
E	0.43	0.48
F	0	0.2
G	2.4	2.9
N	0.63	0.84
P	1.55	-
All Dimensions in mm		

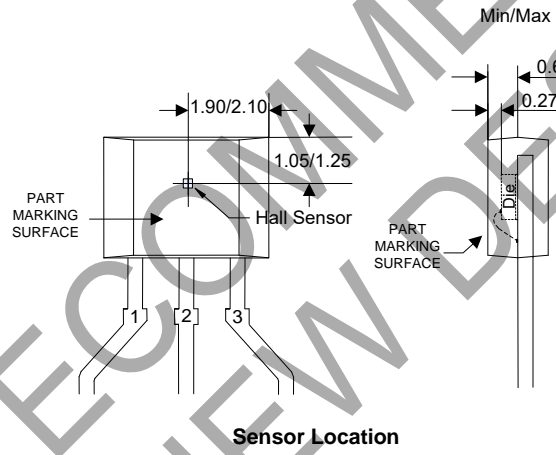

NOT RECOMMENDED FOR NEW DESIGN

**Suggested Pad Layout**

Please see <http://www.diodes.com/package-outlines.html> for the latest version.

(1) Package Type: SC59

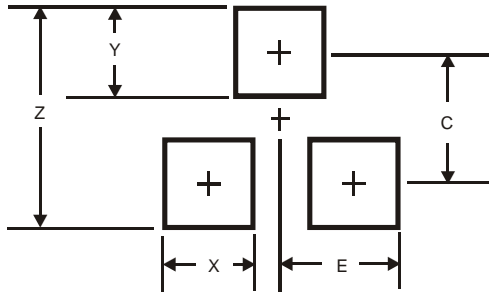

Dimensions	Value (in mm)
Z	3.4
X	0.8
Y	1.0
C	2.4
E	1.35

(2) Package Type: SOT23

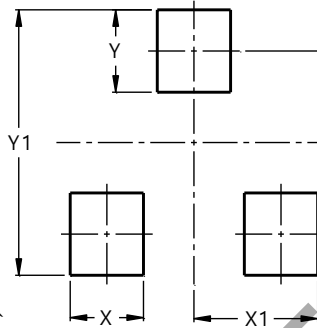

Dimensions	Value (in mm)
C	2.0
X	0.8
X1	1.35
Y	0.9
Y1	2.9

NOT RECOMMENDED FOR NEW DESIGN

**IMPORTANT NOTICE**

1. DIODES INCORPORATED (Diodes) AND ITS SUBSIDIARIES MAKE NO WARRANTY OF ANY KIND, EXPRESS OR IMPLIED, WITH REGARDS TO ANY INFORMATION CONTAINED IN THIS DOCUMENT, INCLUDING, BUT NOT LIMITED TO, THE IMPLIED WARRANTIES OF MERCHANTABILITY, FITNESS FOR A PARTICULAR PURPOSE OR NON-INFRINGEMENT OF THIRD PARTY INTELLECTUAL PROPERTY RIGHTS (AND THEIR EQUIVALENTS UNDER THE LAWS OF ANY JURISDICTION).
2. The Information contained herein is for informational purpose only and is provided only to illustrate the operation of Diodes' products described herein and application examples. Diodes does not assume any liability arising out of the application or use of this document or any product described herein. This document is intended for skilled and technically trained engineering customers and users who design with Diodes' products. Diodes' products may be used to facilitate safety-related applications; however, in all instances customers and users are responsible for (a) selecting the appropriate Diodes products for their applications, (b) evaluating the suitability of Diodes' products for their intended applications, (c) ensuring their applications, which incorporate Diodes' products, comply the applicable legal and regulatory requirements as well as safety and functional-safety related standards, and (d) ensuring they design with appropriate safeguards (including testing, validation, quality control techniques, redundancy, malfunction prevention, and appropriate treatment for aging degradation) to minimize the risks associated with their applications.
3. Diodes assumes no liability for any application-related information, support, assistance or feedback that may be provided by Diodes from time to time. Any customer or user of this document or products described herein will assume all risks and liabilities associated with such use, and will hold Diodes and all companies whose products are represented herein or on Diodes' websites, harmless against all damages and liabilities.
4. Products described herein may be covered by one or more United States, international or foreign patents and pending patent applications. Product names and markings noted herein may also be covered by one or more United States, international or foreign trademarks and trademark applications. Diodes does not convey any license under any of its intellectual property rights or the rights of any third parties (including third parties whose products and services may be described in this document or on Diodes' website) under this document.
5. Diodes' products are provided subject to Diodes' Standard Terms and Conditions of Sale (<https://www.diodes.com/about/company/terms-and-conditions/terms-and-conditions-of-sales/>) or other applicable terms. This document does not alter or expand the applicable warranties provided by Diodes. Diodes does not warrant or accept any liability whatsoever in respect of any products purchased through unauthorized sales channel.
6. Diodes' products and technology may not be used for or incorporated into any products or systems whose manufacture, use or sale is prohibited under any applicable laws and regulations. Should customers or users use Diodes' products in contravention of any applicable laws or regulations, or for any unintended or unauthorized application, customers and users will (a) be solely responsible for any damages, losses or penalties arising in connection therewith or as a result thereof, and (b) indemnify and hold Diodes and its representatives and agents harmless against any and all claims, damages, expenses, and attorney fees arising out of, directly or indirectly, any claim relating to any noncompliance with the applicable laws and regulations, as well as any unintended or unauthorized application.
7. While efforts have been made to ensure the information contained in this document is accurate, complete and current, it may contain technical inaccuracies, omissions and typographical errors. Diodes does not warrant that information contained in this document is error-free and Diodes is under no obligation to update or otherwise correct this information. Notwithstanding the foregoing, Diodes reserves the right to make modifications, enhancements, improvements, corrections or other changes without further notice to this document and any product described herein. This document is written in English but may be translated into multiple languages for reference. Only the English version of this document is the final and determinative format released by Diodes.
8. Any unauthorized copying, modification, distribution, transmission, display or other use of this document (or any portion hereof) is prohibited. Diodes assumes no responsibility for any losses incurred by the customers or users or any third parties arising from any such unauthorized use.
9. This Notice may be periodically updated with the most recent version available at <https://www.diodes.com/about/company/terms-and-conditions/important-notice>

The Diodes logo is a registered trademark of Diodes Incorporated in the United States and other countries.  
All other trademarks are the property of their respective owners.  
© 2023 Diodes Incorporated. All Rights Reserved.

[www.diodes.com](http://www.diodes.com)