

Description

The AH3768Q is an AEC-Q100 qualified, high-voltage, low-sensitivity Hall-Effect latch IC designed for brushless DC-motor commutation, speed measurement, angular or linear encoders and position sensors in automotive applications. To support wide range of demanding applications, the design is optimized to operate over the supply range of 3.0V to 28V. With chopper stabilized architecture and an internal bandgap regulator to provide temperature compensated supply for internal circuits, the AH3768Q provides a reliable solution over the whole operating range. For robustness and protection, the device has a reverse blocking diode with a Zener clamp on the supply. The output has an over current limit and a Zener clamp.

The single, open-drain output can be switched on with South pole of sufficient strength and switched off with North pole of sufficient strength. When the magnetic flux density (B) perpendicular to the package is larger than the operate point (Bop) the output is switched on (pulled low). The output is held latched until magnetic flux density reverses and becomes lower than the release point (Brp).

Pin Assignments

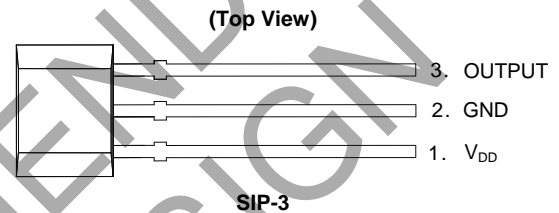
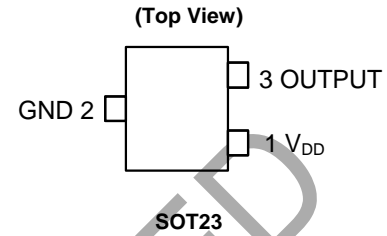

Features

- Bipolar Latch Operation (South Pole: On, North Pole: off)
- High Sensitivity: Bop and Brp of +175G and -175G Typical
- Single, Open-Drain Output with Overcurrent Limit
- 3.0V to 28V Operating Voltage Range
- Chopper Stabilized Design Provides
 - Superior Temperature Stability
 - Minimal Switch Point Drift
 - Enhanced Immunity to Stress
- Good RF Noise Immunity
- Reverse Blocking Diode
- Zener Clamp on Supply and Output Pins
- -40°C to +150°C Operating Temperature
- ESD: HBM > 8kV, CDM: >2kV
- AEC-Q100 Grade 0 Qualified
- Industry Standard SOT23 and SIP-3 Packages
- **Totally Lead-Free & Fully RoHS Compliant (Notes 1 & 2)**
- **Halogen and Antimony Free. "Green" Device (Note 3)**

Applications

- Brushless DC-Motor Commutation
- Revolution Per Minute (RPM) Measurement
- Angular and Linear Encoder and Position Sensing and Indexing
- Flow Meters
- Contactless Commutation, Speed Measurement and Angular Position Sensing/Indexing in Automotive Applications

Notes: 1. No purposely added lead. Fully EU Directive 2002/95/EC (RoHS) & 2011/65/EU (RoHS 2) compliant.
 2. See http://www.diodes.com/quality/lead_free.html for more information about Diodes Incorporated's definitions of Halogen- and Antimony-free, "Green" and Lead-free.
 3. Halogen- and Antimony-free "Green" products are defined as those which contain <900ppm bromine, <900ppm chlorine (<1500ppm total Br + Cl) and <1000ppm antimony compounds.

Typical Applications Circuit

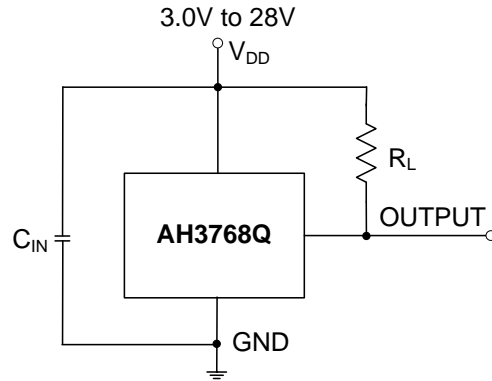

Note: 4. C_{IN} is for power stabilization and to strengthen the noise immunity, the recommended capacitance is 10nF ~ 100nF. R_L is the pull-up resistor.

Pin Descriptions

Package: SOT23 and SIP-3

Pin Number	Pin Name	Function
1	V _{DD}	Power Supply Input
2	GND	Ground
3	OUTPUT	Output Pin

Functional Block Diagram

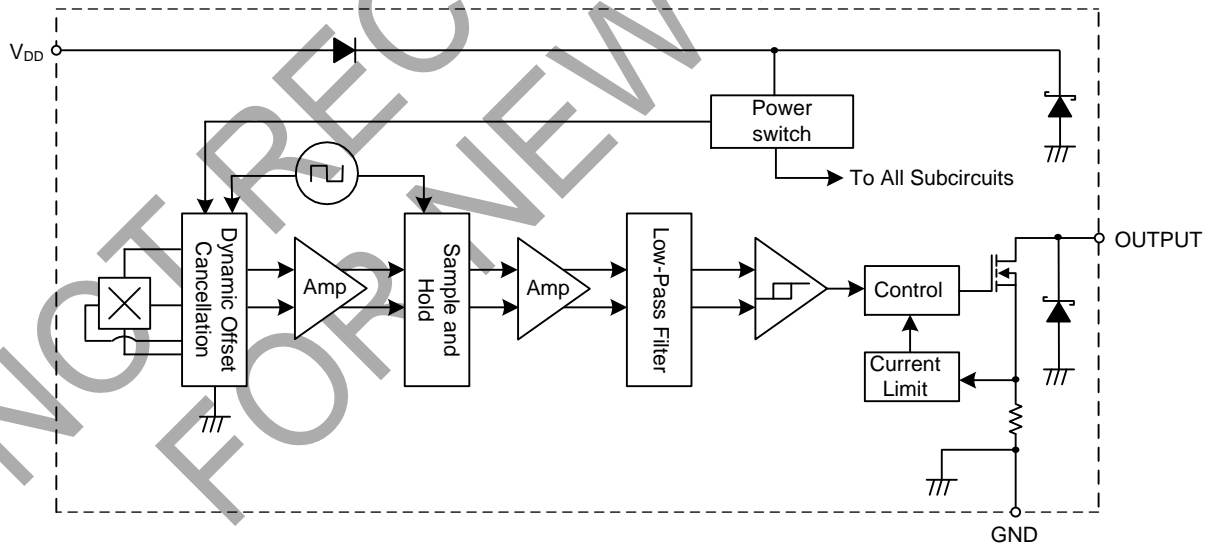

Absolute Maximum Ratings (Notes 5 & 6) (@T_A = +25°C, unless otherwise specified.)

Symbol	Characteristic	Value	Unit	
V _{DD}	Supply Voltage (Note 6)	32	V	
V _{DDR}	Reverse Supply Voltage (Note 6)	-32	V	
V _{OUT_MAX}	Output Off Voltage (Note 6)	32	V	
I _{OUT}	Continuous Output Current	60	mA	
I _{OUT_R}	Reverse Output Current	-50	mA	
B	Magnetic Flux Density	Unlimited		
P _D	Package Power Dissipation	SIP-3	550	mW
		SOT23	230	
T _s	Storage Temperature Range	-65 to +165	°C	
T _J	Maximum Junction Temperature	+150	°C	
ESD HBM	Electrostatic Discharge Withstand - Human Body Model (HBM)	8	kV	
ESD MM	Electrostatic Discharge Withstand - Machine Model (MM)	800	V	
ESD CDM	Electrostatic Discharge Withstand - Charged Device Model (CDM)	2	kV	

- Notes:
- Stresses greater than the 'Absolute Maximum Ratings' specified above may cause permanent damage to the device. These are stress ratings only; functional operation of the device at these or any other conditions exceeding those indicated in this specification is not implied. Device reliability may be affected by exposure to absolute maximum rating conditions for extended periods of time.
 - The absolute maximum V_{DD} of 32V is a transient stress rating and is not meant as a functional operating condition. It is not recommended to operate the device at the absolute maximum rated conditions for any period of time.

Recommended Operating Conditions (@T_A = -40°C to +150°C, unless otherwise specified.)

Symbol	Parameter	Conditions	Rating	Unit
V _{DD}	Supply Voltage	Operating	3.0 to 28	V
T _A	Operating Temperature Range	Operating	-40 to +150	°C

Electrical Characteristics (Notes 7 & 8) (@T_A = -40°C to +150°C, V_{DD} = 3V to 28V, unless otherwise specified.)

Symbol	Parameter	Conditions	Min	Typ	Max	Unit
V _{OUT_ON}	Output On-Voltage	I _{OUT} = 20mA, B > B _{op}	-	0.2	0.4	V
I _{LKG}	Output Leakage Current (when output is off)	V _{OUT} = 28V, B < B _{rp} , Output off	-	<0.1	10	μA
I _{DD}	Supply Current	Output open, T _A = +25°C	-	3	3.5	mA
		Output open, T _A = -40°C to +150°C	-	-	4	mA
I _{DD_R}	Reverse Supply Current	V _{DD} = -18V, T _A = +25°C	-	0.6	-	μA
		V _{DD} = -18V, T _A = -40°C to +150°C	-	0.6	1,500	μA
		V _{DD} = -28V, T _A = +25°C	-	1.6	-	μA
		V _{DD} = -28V, T _A = -40°C to +150°C	-	1.6	2,500	μA
t _{P_ON}	Device Power-On Time (start-up time)	V _{DD} ≥ 3V, B > B _{op} (Note 7)	-	10	-	μs
f _c	Chopping Frequency	V _{DD} ≥ 3V	-	800	-	kHz
t _d	Response Time Delay (time from magnetic threshold reached to the start of the output rise or fall)	(Note 9)	-	3.75	-	μs
t _r	Output Rising Time (external pull-up resistor R _L and load capacitance dependent)	R _L = 1kΩ, C _L = 20pF	-	0.2	1	μs
t _f	Output Falling Time (Internal switch resistance and load capacitance dependent)	R _L = 1kΩ, C _L = 20pF	-	0.1	1	μs
I _{OCL}	Output Current Limit	B > B _{op} , (Note 10)	30	-	55	mA
V _Z	Zener Clamp Voltage	I _{DD} = 5mA	28	-	-	V

- Notes:
- When power is initially turned on, V_{DD} must be within its correct operating range (3.0V to 28V) to guarantee the output sampling. The output state is valid after the start-up time of 10μs typical from the operating voltage reaching 3V.
 - Typical values are defined at T_A = +25°C, V_{DD} = 12V. Maximum and minimum values over the operating temperature range is not tested in production but guaranteed by design, process control and characterization.
 - Guaranteed by design, process control and characterization. Not tested in production.
 - The device will limit the output current I_{OUT} to current limit of I_{OCL}.

Magnetic Characteristics (Notes 11 & 12) ($T_A = -40^{\circ}\text{C}$ to $+150^{\circ}\text{C}$, $V_{DD} = 3.0\text{V}$ to 28V , unless otherwise specified)

(1mT=10 Gauss)

Symbol	Parameter	Conditions	Min	Typ	Max	Unit
Bops (South pole to part marking side for SOT23 and SIP-3 packages)	Operation Point	$V_{DD} = 12\text{V}$, $T_A = +25^{\circ}\text{C}$	-	175	-	Gauss
		$T_A = -40^{\circ}\text{C}$ to $+150^{\circ}\text{C}$	140	175	200	
Brps (North pole to part marking side for SOT23 and SIP-3 packages)	Release Point	$V_{DD} = 12\text{V}$, $T_A = +25^{\circ}\text{C}$	-	-175	-	
		$T_A = -40^{\circ}\text{C}$ to $+150^{\circ}\text{C}$	-200	-175	-140	
Bhy ($ B_{opx} - B_{rpx} $)	Hysteresis (Note 13)	$V_{DD} = 12\text{V}$, $T_A = +25^{\circ}\text{C}$	-	350	-	
		$T_A = -40^{\circ}\text{C}$ to $+150^{\circ}\text{C}$	280	350	400	

- Notes:
- When power is initially turned on, V_{DD} must be within its correct operating range (3.0V to 28V) to guarantee the output sampling. The output state is valid after the start-up time of 10 μs typical from the operating voltage reaching 3V.
 - Typical values are defined at $T_A = +25^{\circ}\text{C}$, $V_{DD} = 12\text{V}$. Maximum and minimum values over the operating temperature range is not tested in production but guaranteed by design, process control and characterization.
 - Maximum and minimum hysteresis is guaranteed by design, process control and characterization.

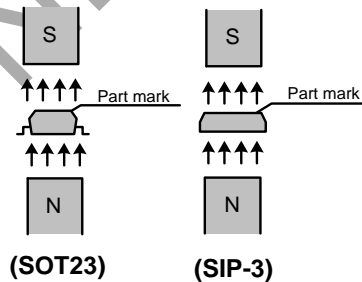
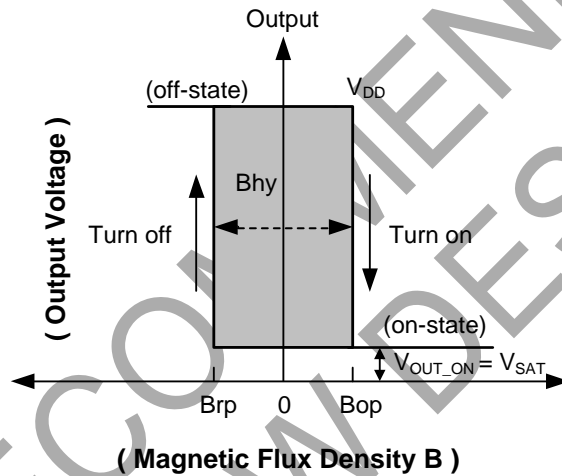

Typical Operating Characteristics

Output Switch Operate and Release Points (Magnetic Thresholds) – Bop and Brp

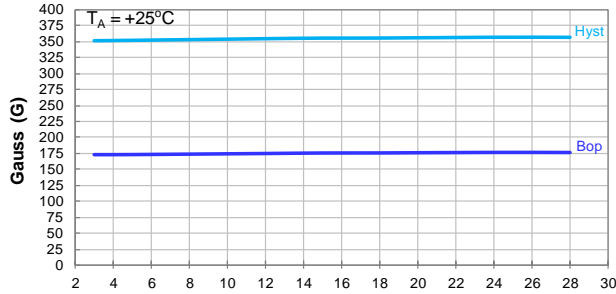

Supply Voltage (V)
Switch Operate Point Bop vs Supply Voltage

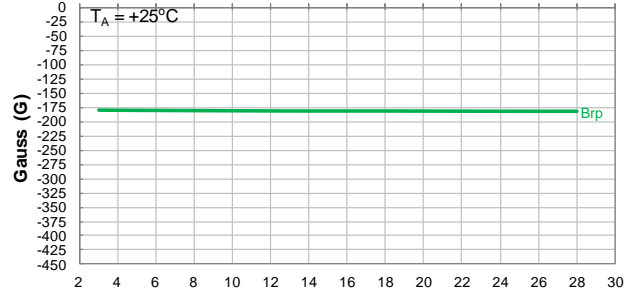

Supply Voltage (V)
Switch Release Point Brp vs Supply Voltage

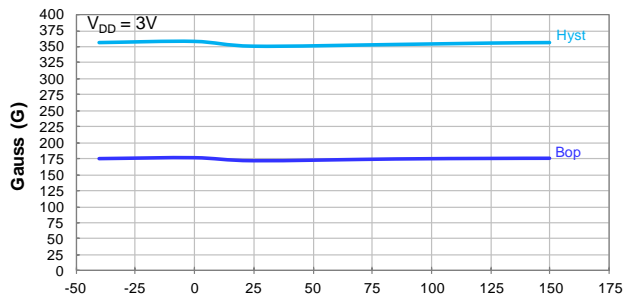

Temperature ($^\circ\text{C}$)
Switch Operate Point Bop vs Temperature

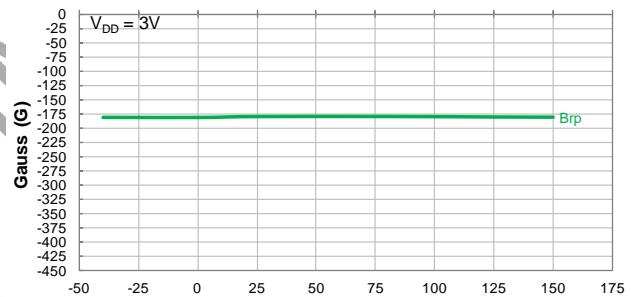

Temperature ($^\circ\text{C}$)
Switch Release Point Brp vs Temperature

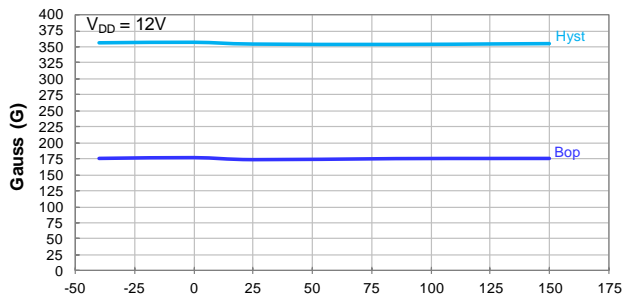

Temperature ($^\circ\text{C}$)
Switch Operate Point Bop vs Temperature

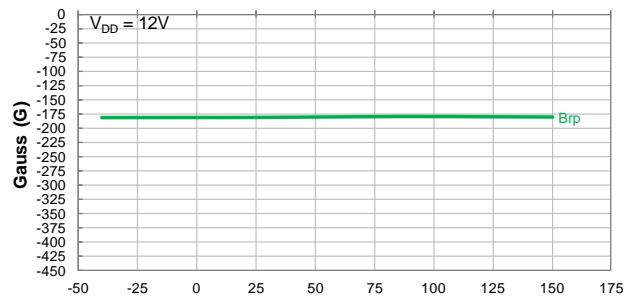

Temperature ($^\circ\text{C}$)
Switch Release Point Brp vs Temperature

Typical Operating Characteristics

Output Switch Operate and Release Points (Magnetic Thresholds) – Bop and Brp (cont.)

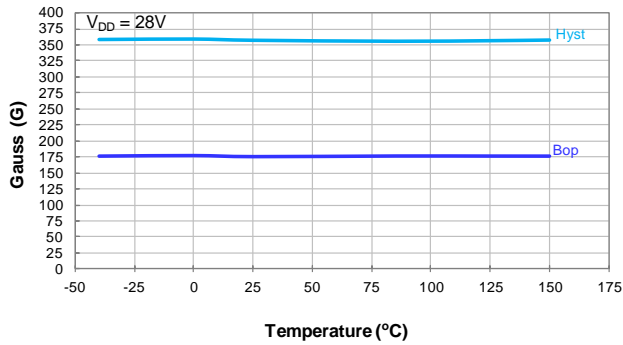

Switch Operate Point Bop vs Temperature

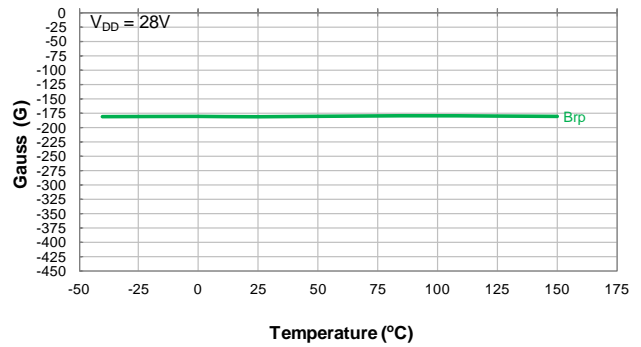

Switch Release Point Brp vs Temperature

Supply Current

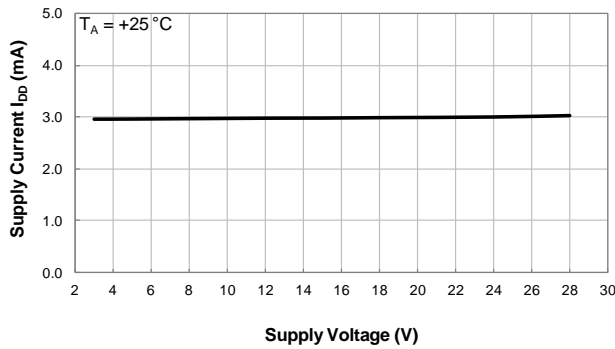

Supply Current vs Supply Voltage

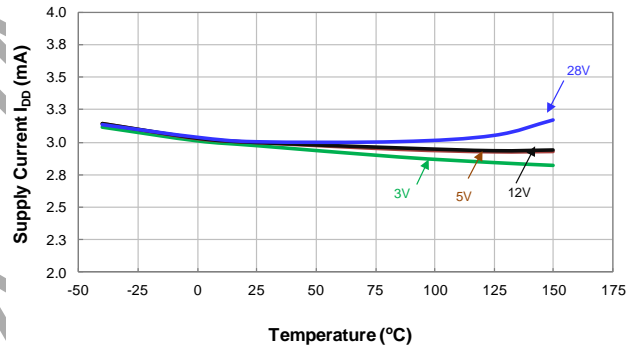

Supply Current vs Temperature

Reverse Supply Current

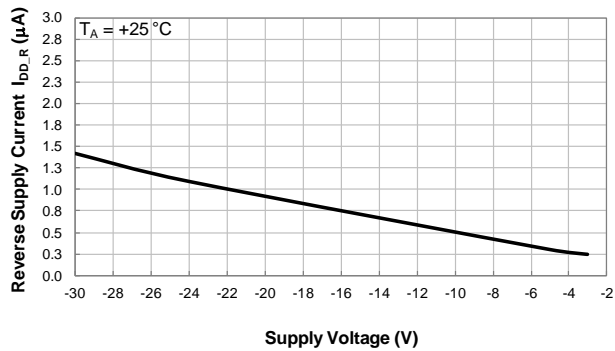

Reverse Supply Current vs Supply Voltage

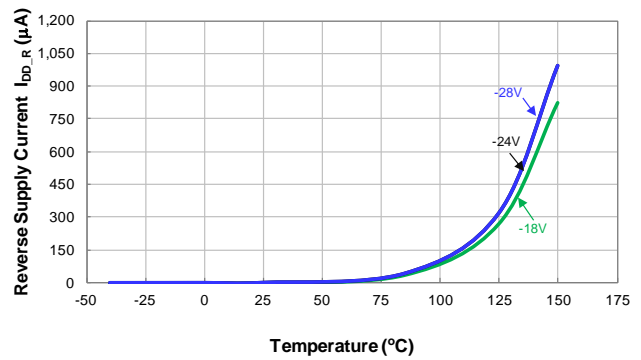

Reverse Supply Current vs Temperature

Typical Operating Characteristics (cont.)

Output Switch On-Voltage

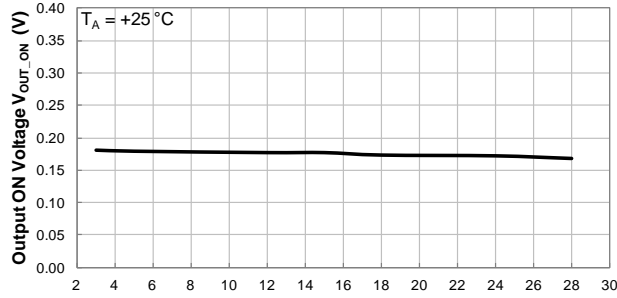

Supply Voltage (V)
Output ON Voltage vs Supply Voltage

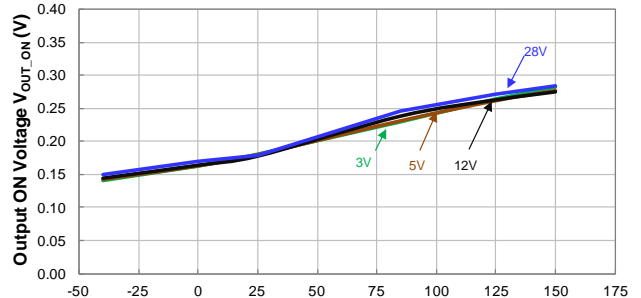

Temperature (°C)
Output ON Voltage vs Temperature

Output Switch Leakage Current

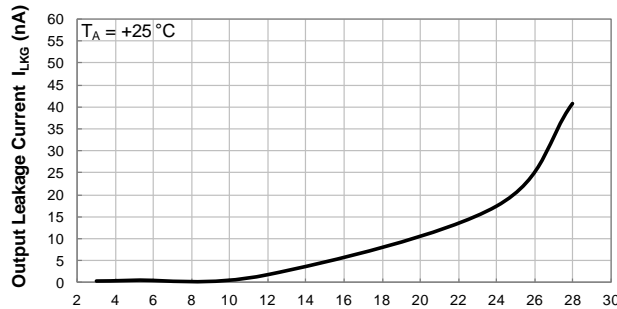

Supply Voltage (V)
Output Leakage Current vs Supply Voltage

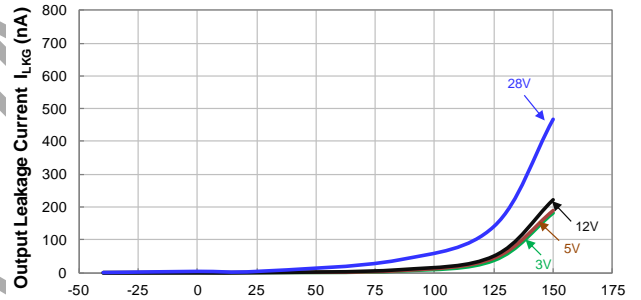

Temperature (°C)
Output Leakage Current vs Temperature

Output Current Limit

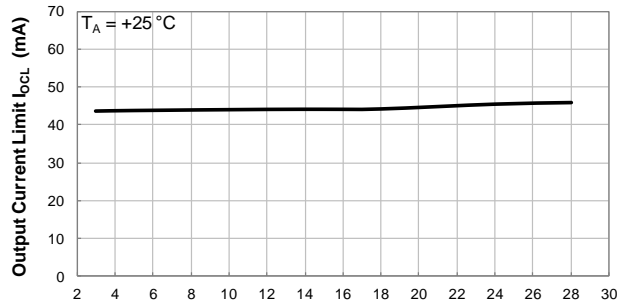

Supply Voltage (V)
Output Current Limit vs Supply Voltage

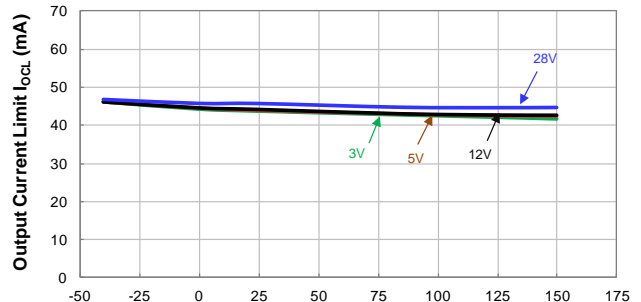

Temperature (°C)
Output Current Limit vs Temperature

Thermal Performance Characteristics

(1) Package type: SOT23

T _A (°C)	25	50	60	70	80	85	90	100	105	110	120	125	130	140	150
P _D (mW)	230	184	166	147	129	120	110	92	83	74	55	46	37	18	0

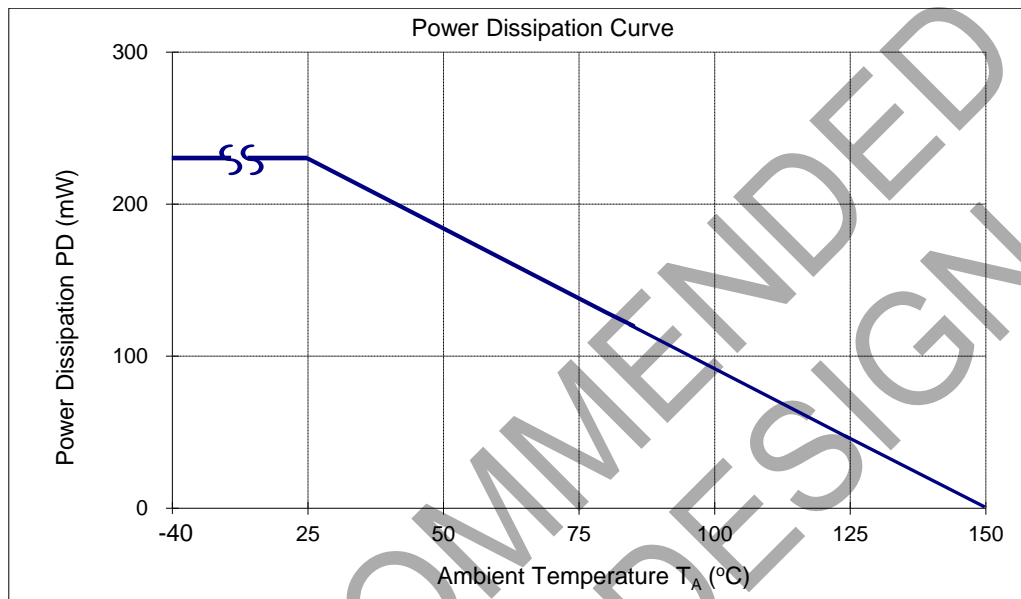

(2) Package type: SIP-3

T _A (°C)	25	50	60	70	80	85	90	100	105	110	120	125	130	140	150
P _D (mW)	550	440	396	362	308	286	264	220	198	176	132	110	88	44	0

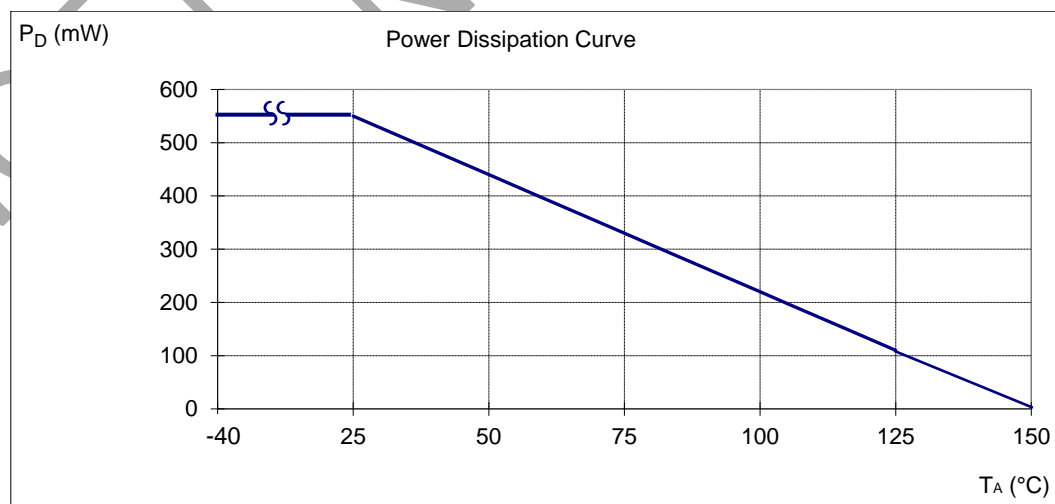

Ordering Information

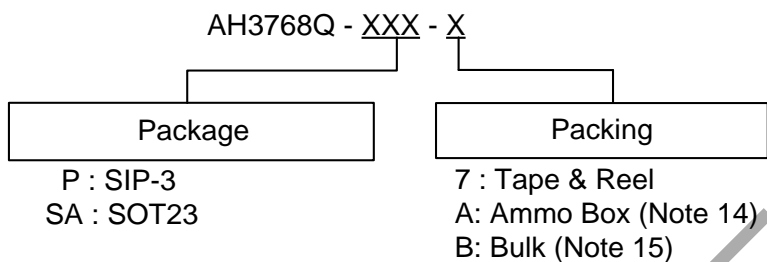

Part Number	Package Code	Packaging	Bulk		7" Tape and Reel		Ammo Box	
			Quantity	Part Number Suffix	Quantity	Part Number Suffix	Quantity	Part Number Suffix
AH3768Q-P-A	P	SIP-3	NA	NA	NA	NA	4,000/Box	-A
AH3768Q-P-B	P	SIP-3	1,000	-B	NA	NA	NA	NA
AH3768Q-SA-7	SA	SOT23	NA	NA	3,000/Tape & Reel	-7	NA	NA

Notes: 14. Ammo Box is for SIP-3 Spread Lead.
15. Bulk is for SIP-3 Straight Lead.

Marking Information

(1) Package Type: SOT23

(Top View)

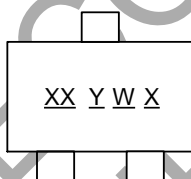

XX : Identification code
Y : Year 0 to 9
W : Week : A to Z : 1 to 26 week;
a to z : 27 to 52 week; z represents
52 and 53 week
X : Internal code

Part Number	Package	Identification Code
AH3768Q	SOT23	WT

(2) Package Type: SIP-3

(Top View)

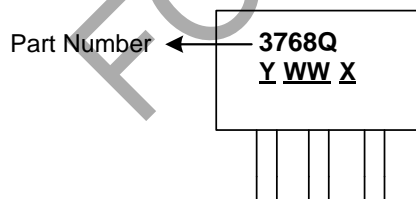

Y : Year : 0~9
WW : Week : 01~52, "52" represents
52 and 53 week
X : Internal Code

Part Number	Package	Identification Code
AH3768Q	SIP-3	3768Q

Package Outline Dimensions (All dimensions in mm.)

Please see AP02002 at <http://www.diodes.com/datasheets/ap02002.pdf> for the latest version.

(1) Package Type: SOT23

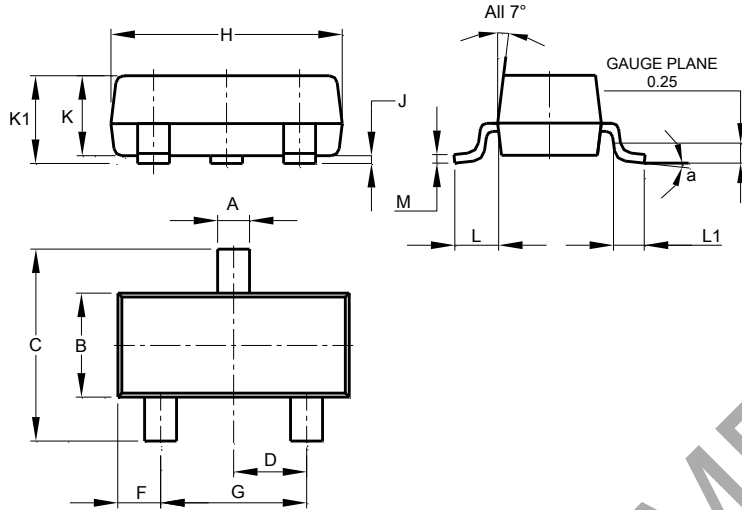

SOT23			
Dim	Min	Max	Typ
A	0.37	0.51	0.40
B	1.20	1.40	1.30
C	2.30	2.50	2.40
D	0.89	1.03	0.915
F	0.45	0.60	0.535
G	1.78	2.05	1.83
H	2.80	3.00	2.90
J	0.013	0.10	0.05
K	0.890	1.00	0.975
K1	0.903	1.10	1.025
L	0.45	0.61	0.55
L1	0.25	0.55	0.40
M	0.085	0.150	0.110
a	8°		
All Dimensions in mm			

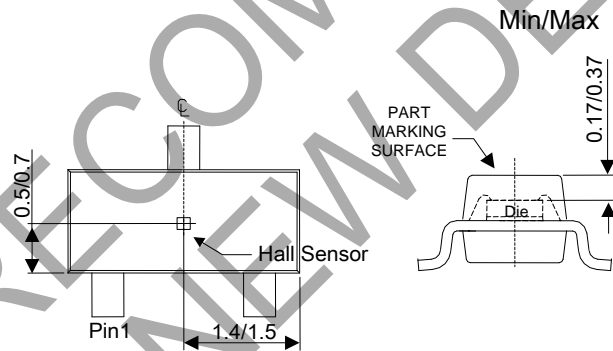

Sensor Location – To be updated

NOT RECOMMENDED FOR NEW DESIGN

Package Outline Dimensions (cont.) (All dimensions in mm.)

Please see AP02002 at <http://www.diodes.com/datasheets/ap02002.pdf> for the latest version.

(2) Package Type: SIP-3 Bulk

Sensor location to be added

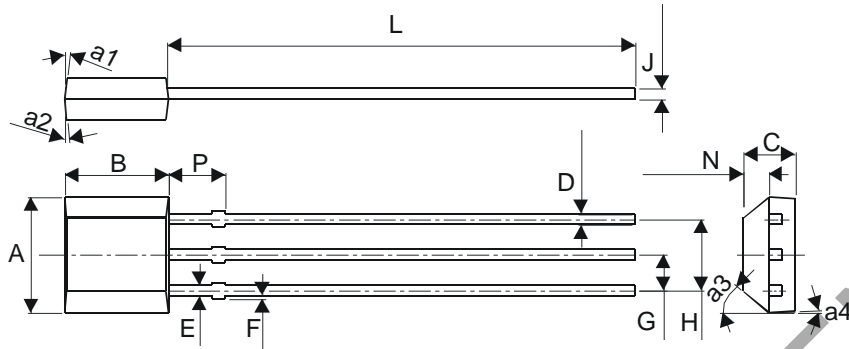

SIP-3 (Bulk)		
Dim	Min	Max
A	3.9	4.3
a1	5° Typ	
a2	5° Typ	
a3	45° Typ	
a4	3° Typ	
B	2.8	3.2
C	1.40	1.60
D	0.33	0.432
E	0.40	0.508
F	0	0.2
G	1.24	1.30
H	2.51	2.57
J	0.35	0.43
L	14.0	15.0
N	0.63	0.84
P	1.55	-
All Dimensions in mm		

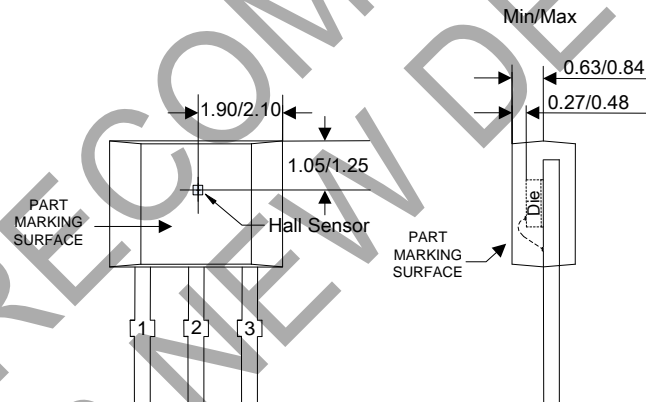

Sensor Location – To be updated

Package Outline Dimensions (cont.) (All dimensions in mm.)

Please see AP02002 at <http://www.diodes.com/datasheets/ap02002.pdf> for the latest version.

(3) Package Type: SIP-3 Ammo Pack

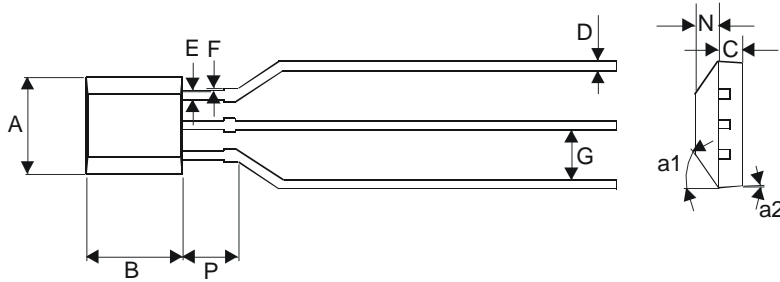

SIP-3 (Ammo Pack)		
Dim	Min	Max
A	3.9	4.3
a1	45° Typ	
a2	3° Typ	
B	2.8	3.2
C	1.40	1.60
D	0.35	0.41
E	0.43	0.48
F	0	0.2
G	2.4	2.9
N	0.63	0.84
P	1.55	-
All Dimensions in mm		

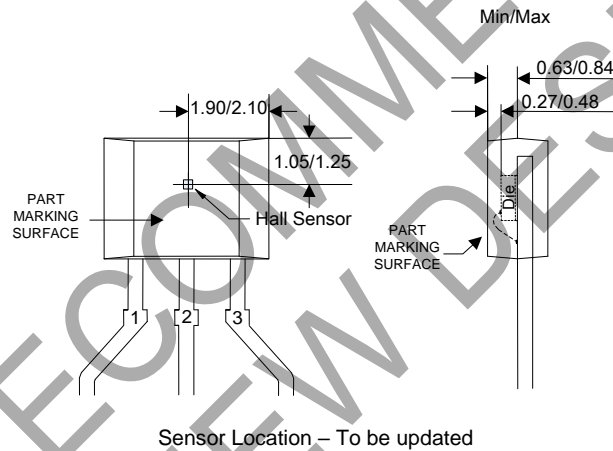

Suggested Pad Layout

Please see AP02001 at <http://www.diodes.com/datasheets/ap02001.pdf> for the latest version.

(1) Package Type: SOT23

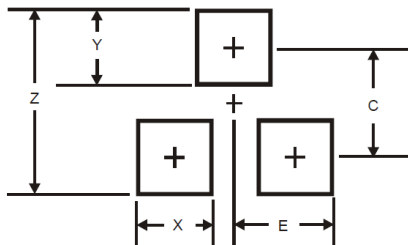

Dimensions	Value (in mm)
Z	2.9
X	0.8
Y	0.9
C	2.0
E	1.35

IMPORTANT NOTICE

1. DIODES INCORPORATED (Diodes) AND ITS SUBSIDIARIES MAKE NO WARRANTY OF ANY KIND, EXPRESS OR IMPLIED, WITH REGARDS TO ANY INFORMATION CONTAINED IN THIS DOCUMENT, INCLUDING, BUT NOT LIMITED TO, THE IMPLIED WARRANTIES OF MERCHANTABILITY, FITNESS FOR A PARTICULAR PURPOSE OR NON-INFRINGEMENT OF THIRD PARTY INTELLECTUAL PROPERTY RIGHTS (AND THEIR EQUIVALENTS UNDER THE LAWS OF ANY JURISDICTION).
2. The Information contained herein is for informational purpose only and is provided only to illustrate the operation of Diodes' products described herein and application examples. Diodes does not assume any liability arising out of the application or use of this document or any product described herein. This document is intended for skilled and technically trained engineering customers and users who design with Diodes' products. Diodes' products may be used to facilitate safety-related applications; however, in all instances customers and users are responsible for (a) selecting the appropriate Diodes products for their applications, (b) evaluating the suitability of Diodes' products for their intended applications, (c) ensuring their applications, which incorporate Diodes' products, comply the applicable legal and regulatory requirements as well as safety and functional-safety related standards, and (d) ensuring they design with appropriate safeguards (including testing, validation, quality control techniques, redundancy, malfunction prevention, and appropriate treatment for aging degradation) to minimize the risks associated with their applications.
3. Diodes assumes no liability for any application-related information, support, assistance or feedback that may be provided by Diodes from time to time. Any customer or user of this document or products described herein will assume all risks and liabilities associated with such use, and will hold Diodes and all companies whose products are represented herein or on Diodes' websites, harmless against all damages and liabilities.
4. Products described herein may be covered by one or more United States, international or foreign patents and pending patent applications. Product names and markings noted herein may also be covered by one or more United States, international or foreign trademarks and trademark applications. Diodes does not convey any license under any of its intellectual property rights or the rights of any third parties (including third parties whose products and services may be described in this document or on Diodes' website) under this document.
5. Diodes' products are provided subject to Diodes' Standard Terms and Conditions of Sale (<https://www.diodes.com/about/company/terms-and-conditions/terms-and-conditions-of-sales/>) or other applicable terms. This document does not alter or expand the applicable warranties provided by Diodes. Diodes does not warrant or accept any liability whatsoever in respect of any products purchased through unauthorized sales channel.
6. Diodes' products and technology may not be used for or incorporated into any products or systems whose manufacture, use or sale is prohibited under any applicable laws and regulations. Should customers or users use Diodes' products in contravention of any applicable laws or regulations, or for any unintended or unauthorized application, customers and users will (a) be solely responsible for any damages, losses or penalties arising in connection therewith or as a result thereof, and (b) indemnify and hold Diodes and its representatives and agents harmless against any and all claims, damages, expenses, and attorney fees arising out of, directly or indirectly, any claim relating to any noncompliance with the applicable laws and regulations, as well as any unintended or unauthorized application.
7. While efforts have been made to ensure the information contained in this document is accurate, complete and current, it may contain technical inaccuracies, omissions and typographical errors. Diodes does not warrant that information contained in this document is error-free and Diodes is under no obligation to update or otherwise correct this information. Notwithstanding the foregoing, Diodes reserves the right to make modifications, enhancements, improvements, corrections or other changes without further notice to this document and any product described herein. This document is written in English but may be translated into multiple languages for reference. Only the English version of this document is the final and determinative format released by Diodes.
8. Any unauthorized copying, modification, distribution, transmission, display or other use of this document (or any portion hereof) is prohibited. Diodes assumes no responsibility for any losses incurred by the customers or users or any third parties arising from any such unauthorized use.
9. This Notice may be periodically updated with the most recent version available at <https://www.diodes.com/about/company/terms-and-conditions/important-notice>

The Diodes logo is a registered trademark of Diodes Incorporated in the United States and other countries.
All other trademarks are the property of their respective owners.
© 2023 Diodes Incorporated. All Rights Reserved.

www.diodes.com