

## Description

The AH3965/AH3966/AH3967/AH3968 is a high voltage dual Hall-effect sensor designed for the applications that require accurate speed and direction sensing. To support the wide range of the demanding applications, the design has been optimized to operate over the supply range of 2.7V to 27V. With chopper stabilized architecture and an internal bandgap regulator to provide temperature compensated supply for internal circuits, the AH3965/AH3966/AH3967 provides speed and direction outputs, while the AH3968 provides two independent outputs at Q1 and Q2.

For robustness and protection, the device has a reverse blocking diode with a Zener clamp on the supply.

In the occasion of a supply voltage drop to minimum threshold point, undervoltage lockout protection would be triggered to freeze the device, which prevents the electrical malfunction from affecting the next magnetic measurement circuits, and the output current state updated is always based on the proper accurate measurement result.

## Features and Performance

- Dual Latch Hall Operation with Dual Outputs (AH3968) or Speed & Direction Output (AH3965/AH3966/AH3967)
- Wide Supply Voltage Operation: 2.7V to 27V
- Chopper Stabilized Design Provides
  - Superior Temperature Stability
  - Minimal Switch Point Drift
  - Enhanced Immunity to Stress
- Battery Polarity Reverse Connection Protection
- Transient Spike Voltage Protection
- UVLO Protection
- High ESD Rating: HBM = 5kV, CDM = 2kV
- Temperature Range: -40°C to +125°C
- **Totally Lead-Free & Fully RoHS Compliant (Notes 1 & 2)**
- **Halogen and Antimony Free. "Green" Device (Note 3)**
- **An automotive-compliant part is available under separate datasheet ([AH396XQ](#))**

## Pin Assignments

(Top View)

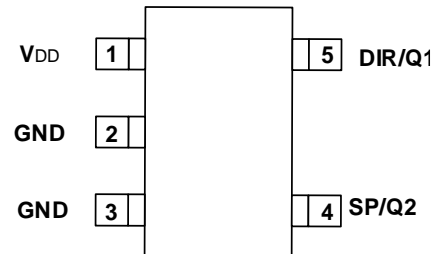

TSOT25 (Type A1)

## Applications

- Industrial motors
- White goods
- Pumps
- Rotation speed & direction detection
- Linear speed & direction detection
- Angular position detection

- Notes:
1. No purposely added lead. Fully EU Directive 2002/95/EC (RoHS), 2011/65/EU (RoHS 2) & 2015/863/EU (RoHS 3) compliant.
  2. See <https://www.diodes.com/quality/lead-free/> for more information about Diodes Incorporated's definitions of Halogen- and Antimony-free, "Green" and Lead-free.
  3. Halogen- and Antimony-free "Green" products are defined as those which contain <900ppm bromine, <900ppm chlorine (<1500ppm total Br + Cl) and <1000ppm antimony compounds.

**Typical Applications Circuit**

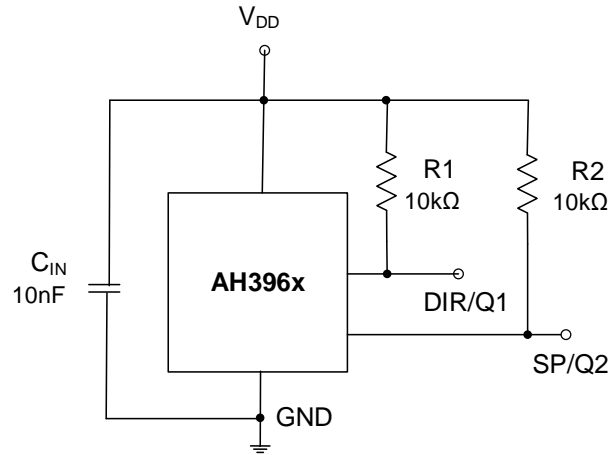

**Pin Descriptions**

Package: TSOT25 (Type A1)

Pin Number	Pin Name		Function
4	AH3965/AH3966/AH3967	SP	Speed, open-drain output
	AH3968	Q2	Speed 2, open-drain output
5	AH3965/AH3966/AH3967	DIR	Direction, open-drain output
	AH3968	Q1	Speed 1, open-drain output
1	V <sub>DD</sub>		Supply voltage input
2	GND		Ground
3	GND		Ground

**Functional Block Diagram**

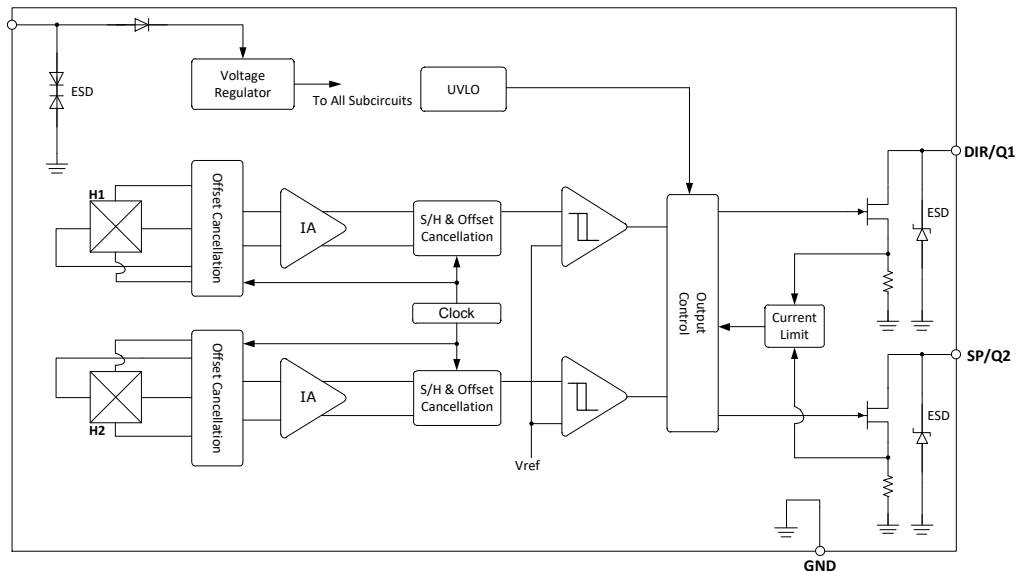

### Absolute Maximum Ratings (Note 4) (@T<sub>A</sub> = +25°C, unless otherwise specified.)

Symbol	Parameter	Rating	Unit
V <sub>DD</sub> (Note 5)	Supply voltage	40	V
V <sub>DDR</sub> (Note 5)	Reverse supply voltage	-18	V
I <sub>DD</sub>	Supply current	50	mA
I <sub>DDR</sub>	Reverse supply current	-50	mA
I <sub>OUT</sub>	Output current	50	mA
I <sub>OUTR</sub>	Reverse output current	-50	mA
B	Magnetic flux density	Unlimited	GS
T <sub>A</sub>	Operation ambient temperature	-40 to +125	°C
T <sub>J</sub>	Maximum junction temperature	+150	°C
T <sub>S</sub>	Storage temperature	-55 to +150	°C
ESD (HBM)	ESD (Human Body Model)	5000	V
ESD (CDM)	ESD (Charged Device Model)	2000	V

Notes:

- Stresses greater than those listed under *Absolute Maximum Ratings* can cause permanent damage to the device. These are stress ratings only, and functional operation of the device at these or any other conditions beyond those indicated under *Recommended Operating Conditions* is not implied. Exposure to *Absolute Maximum Ratings* for extended periods can affect device reliability.
- Should not be exceeding the maximum junction temperature and maximum duration of 500ms.

### Recommended Operating Conditions (@T<sub>A</sub> = -40°C to +125°C, unless otherwise specified.)

Symbol	Parameter	Conditions	Min	Max	Unit
V <sub>DD</sub>	Supply voltage	Operating	2.7	27	V
T <sub>OP</sub>	Operating temperature	Operating	-40	+125	°C

### Electrical Characteristics (Note 6) (@T<sub>A</sub> = -40°C to +125°C, V<sub>DD</sub> = 2.7V to 27V, unless otherwise specified.)

Symbol	Parameter	Conditions	Min	Typ	Max	Units
V <sub>DD</sub>	Supply voltage	Operating	2.7	12	27	V
I <sub>DD</sub>	Supply current	V <sub>DD</sub> = 2.7V to 27V	3.5	4.7	7	mA
V <sub>UVLO</sub>	Undervoltage lockout threshold	V <sub>DD</sub> falling	2.0	2.35	2.7	V
I <sub>DDR</sub>	Reverse supply current	V <sub>DD</sub> = -18V, T <sub>A</sub> = -40°C to +125°C	-1.5	—	—	mA
V <sub>Osat</sub>	Output saturation voltage	B > B <sub>OP</sub> , I <sub>OUT</sub> = 10mA	—	0.2	0.5	V
I <sub>LEK</sub>	Output leakage current	V <sub>OUT</sub> = 12V, V <sub>DD</sub> = 12V, B < B <sub>RP</sub>	—	0.1	1	μA
I <sub>LIM</sub>	Output current limit	Output on	11	25	44	mA
f <sub>M</sub>	Maximum switching frequency*	B > 3 x B <sub>OP</sub> , alternative square magnet field	40	60	—	kHz
f <sub>C</sub>	Chopping frequency*	—	—	500	—	kHz
t <sub>PON</sub>	Power on time (Note 7)	V <sub>DD</sub> = 12V, dV <sub>DD</sub> /dt > 2.7V/μs	—	13	—	μs
t <sub>R</sub>	Output rise time*	V <sub>DD</sub> = 12V, pullup resistor 1kΩ, C <sub>L</sub> = 50pF	—	0.2	1	μs
t <sub>F</sub>	Output fall time*	V <sub>DD</sub> = 12V, pullup resistor 1kΩ, C <sub>L</sub> = 50pF	—	0.2	1	μs
t <sub>D</sub>	Response delay time (Note 8)	B > 3 x B <sub>OP</sub>	—	13	—	μs
t <sub>DC</sub>	Count signal delay (Note 6)	—	50	500	1000	ns
t <sub>JITTER</sub>	Output jitter (Note 6)	—	—	±5	—	μs
d <sub>HALL</sub>	Hall plate distance	—	—	1.45	—	mm
V <sub>Z</sub>	Zener clamp voltage	I <sub>DD</sub> = 8mA, T <sub>A</sub> = +25°C	36	—	—	V

\* Guaranteed by design.

- Notes:
6. Typical values are defined at T<sub>A</sub> = +25°C, V<sub>DD</sub> = 12V. Maximum and minimum values over the operating temperature range are not tested in production but guaranteed by design, process control and characterization.
  7. Time from applying V<sub>DD</sub> ≥ 2.7V to the sensor until the output state is valid.
  8. Time delayed from the magnetic threshold reached to the output rise or fall.

**Magnetic Characteristics** (Notes 6, 9) ( $T_A = -40^{\circ}\text{C}$  to  $+125^{\circ}\text{C}$ ,  $V_{DD} = 2.7\text{V}$  to  $27\text{V}$ , unless otherwise specified.)

Part Name	Operating Point B <sub>OP</sub> (Gauss)			Release Point B <sub>RP</sub> (Gauss)			Hysteresis B <sub>HYS</sub> (Gauss)			Magnetic Matching (Gauss) (Note 10)		Magnetic Offset (Gauss) (Note 10)		T <sub>c</sub> (ppm/°C)	Output			
	Min	Typ	Max	Min	Typ	Max	Min	Typ	Max	Min	Max	Min	Max	Typ	SP	DIR	Q1	Q2
AH3965	-10	10	30	-30	-10	10	5	20	35	-25	25	-15	15	-350	V	V	—	—
AH3966	8	25	42	-42	-25	-8	32	50	68	-20	20	-20	20	-350	V	V	—	—
AH3967	50	75	100	-100	-75	-50	120	150	180	-30	30	-20	20	-350	V	V	—	—
AH3968	50	75	100	-100	-75	-50	120	150	180	-30	30	-20	20	-350	—	—	V	V

Notes: 9. Positive x-axis direction indicates the south pole approaching the part marking surface i.e. increasing south pole magnetic field strength to the sensor; reversing direction x-axis toward 0 means the decreasing south magnetic field strength to the sensor. Negative x-axis indicates north pole magnetic field to the part marking surface.  
 10.  $T_A = +25^{\circ}\text{C}$ ,  $V_{DD} = 2.7\text{V}$  to  $27\text{V}$ .

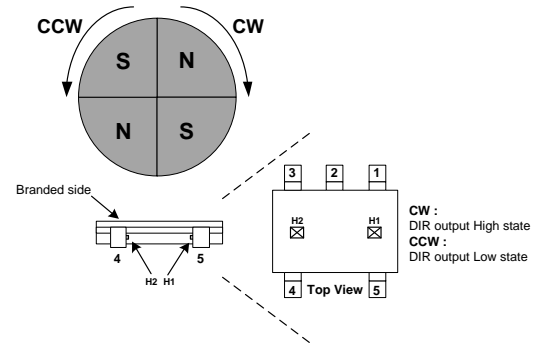
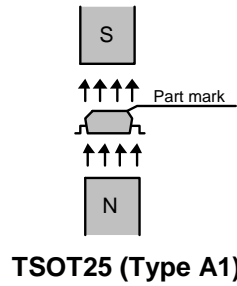
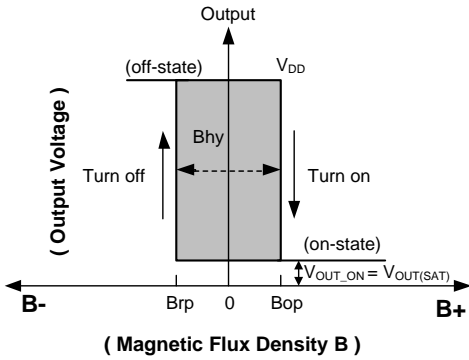

**Operating Characteristics**

Timing Diagrams for the Speed and Direction Output SP/DIR and Two Speed Outputs Q1/Q2

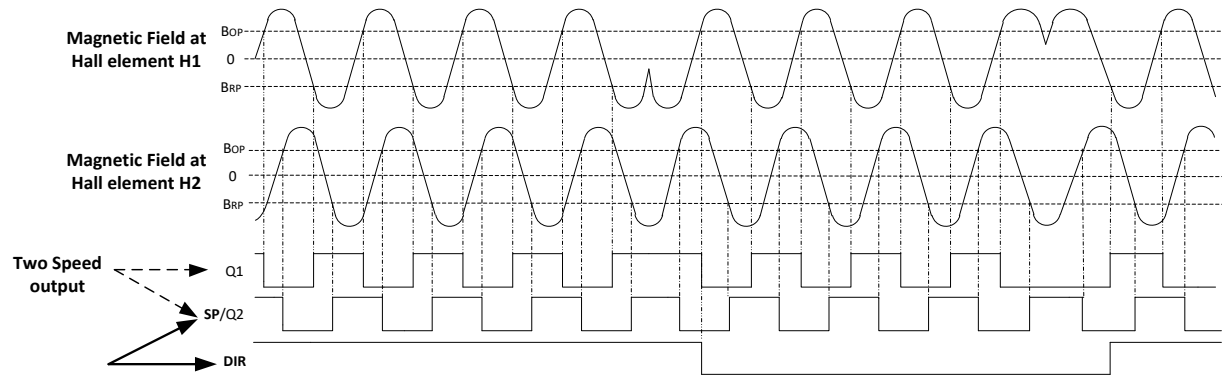

Count Signal Delay t<sub>dc</sub>

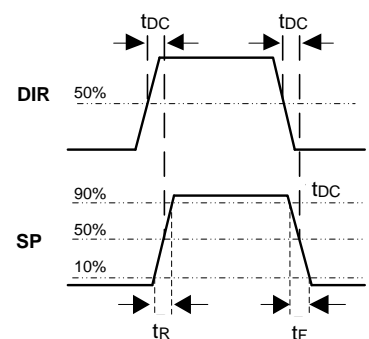

**Performance Characteristics**

**Supply Current  $I_{DD}$**

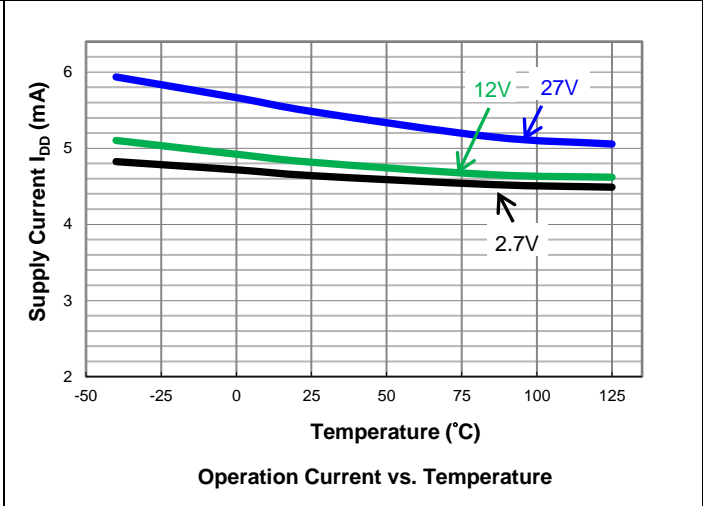
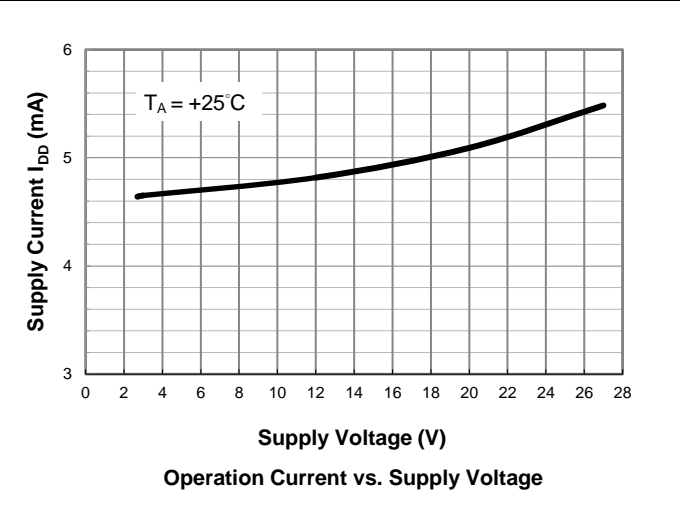

**Reverse Supply Current  $I_{DDR}$**

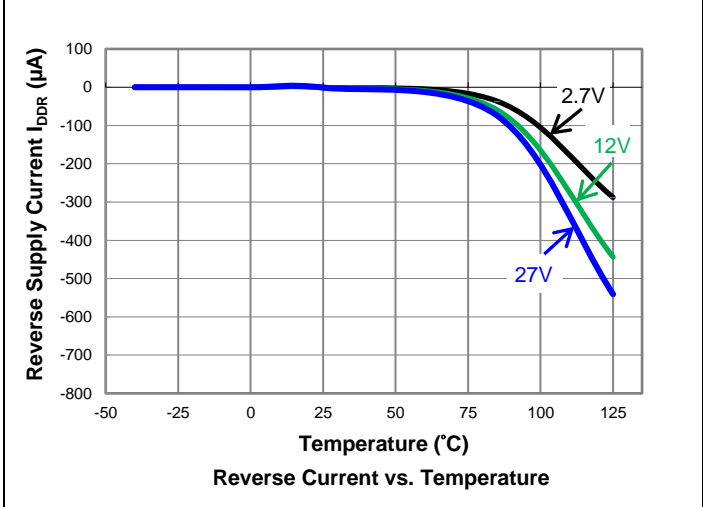
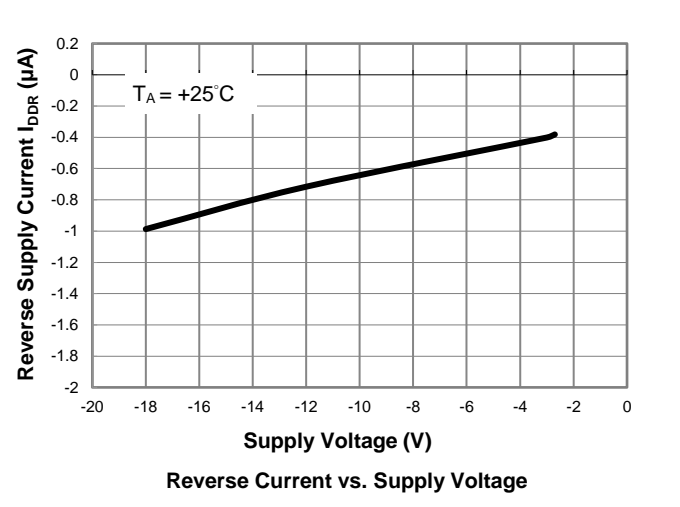

**Undervoltage Lockout Threshold**

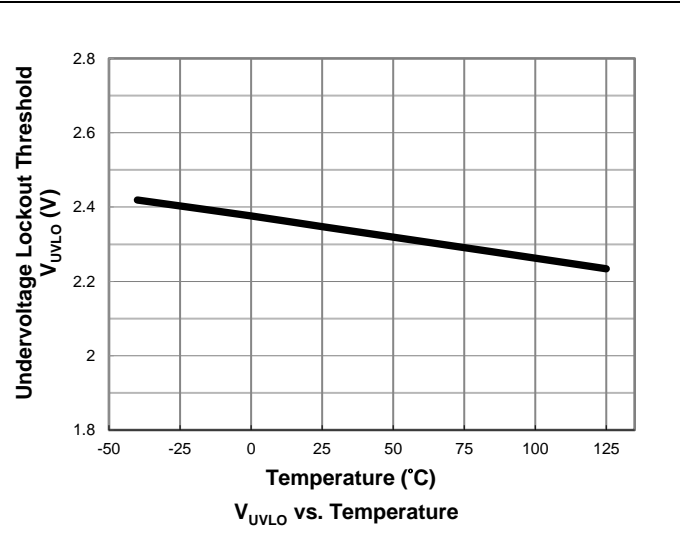

**Performance Characteristics** (continued)

**Output Saturation Voltage  $V_{Osat}$**

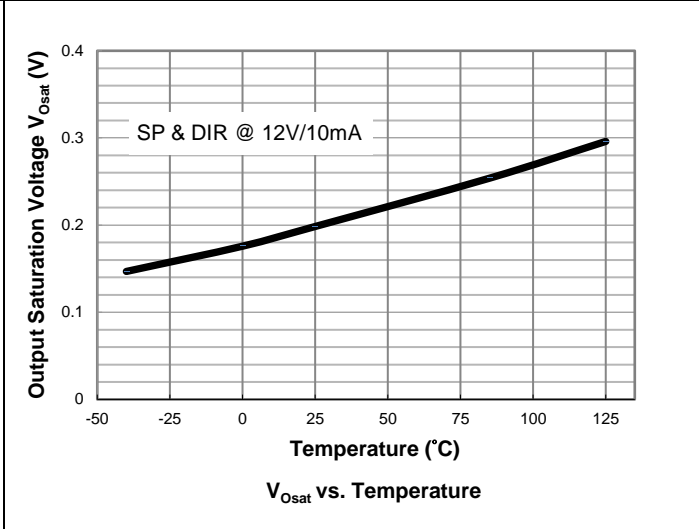
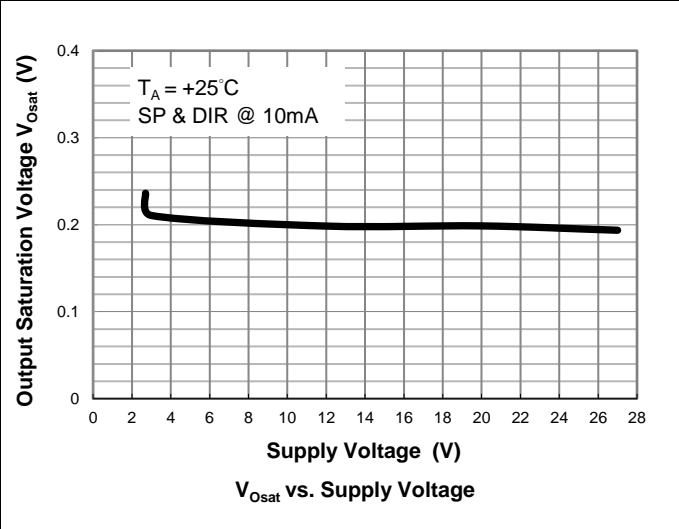

**Output Leakage Current  $I_{LEK}$**

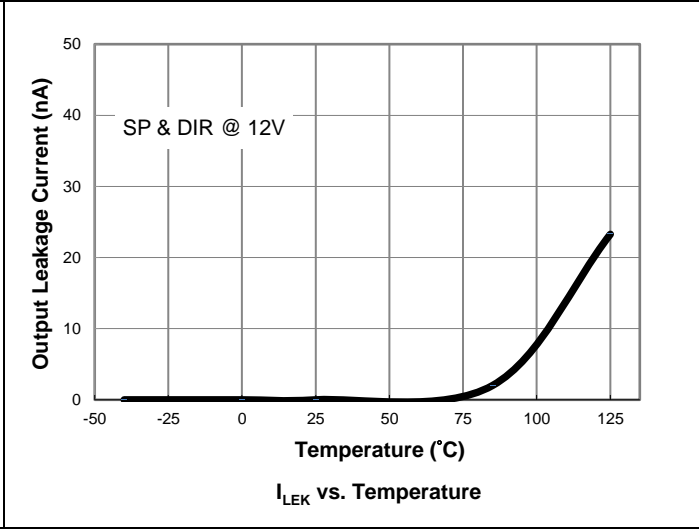
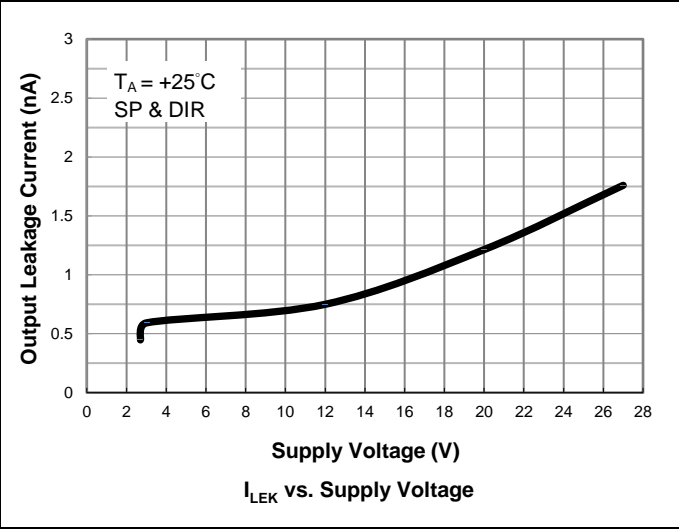

**Output Current Limit  $I_{LIM}$**

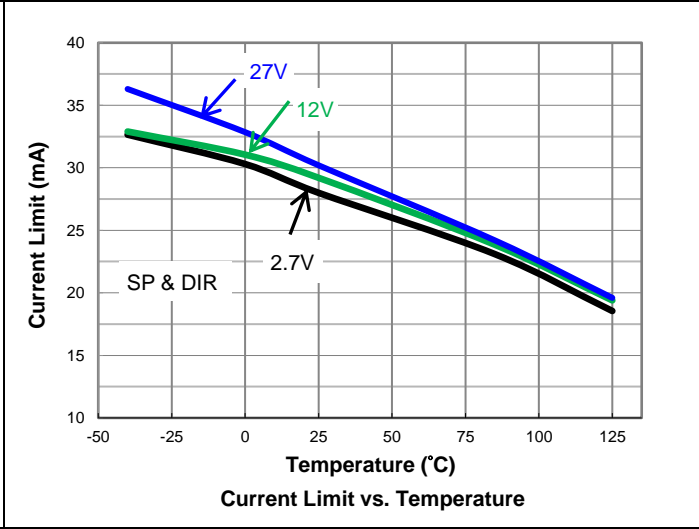
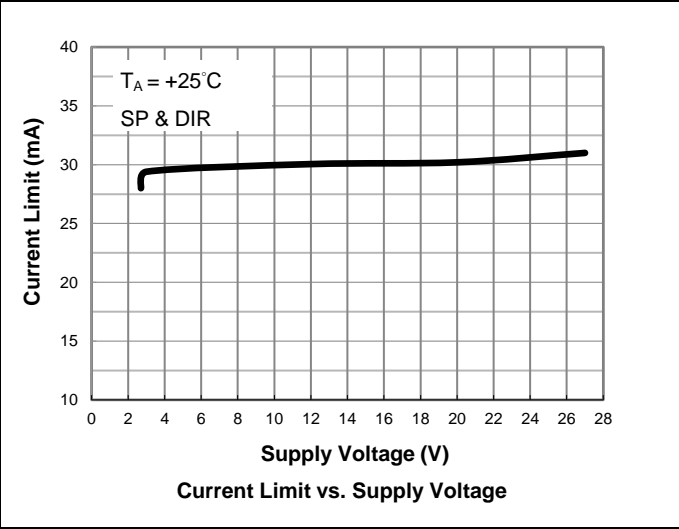

**Performance Characteristics** (continued)

**Output Rise Time  $t_R$  & Output Fall Time  $t_F$**

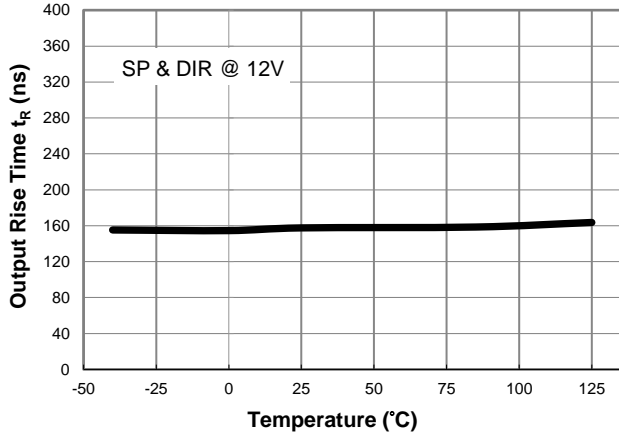

Output Rise Time  $t_R$  vs. Temperature

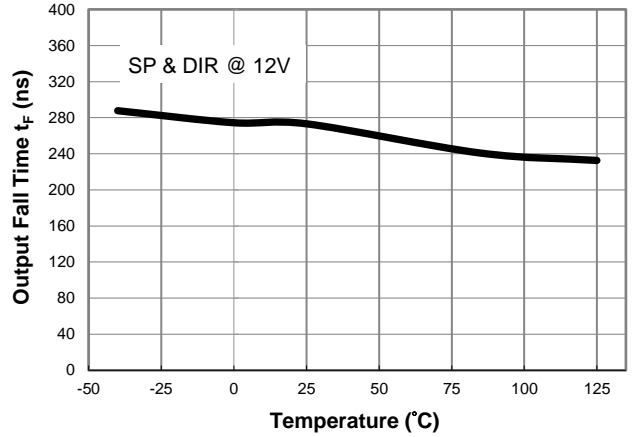

Output Fall Time  $t_F$  vs. Temperature

**Zener Clamp Voltage  $V_Z$**

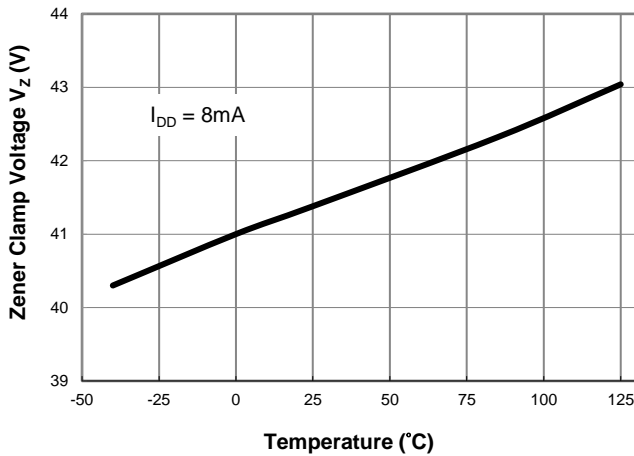

Zener Clamp Voltage  $V_Z$  vs. Temperature

**Power On Time  $t_{PON}$**

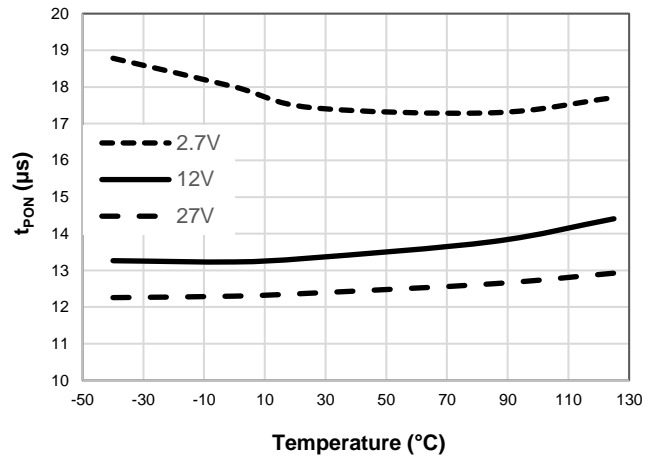

$t_{PON}$  vs. Temperature



**Performance Characteristics** (continued)

**AH3965 Magnetic Characteristics**

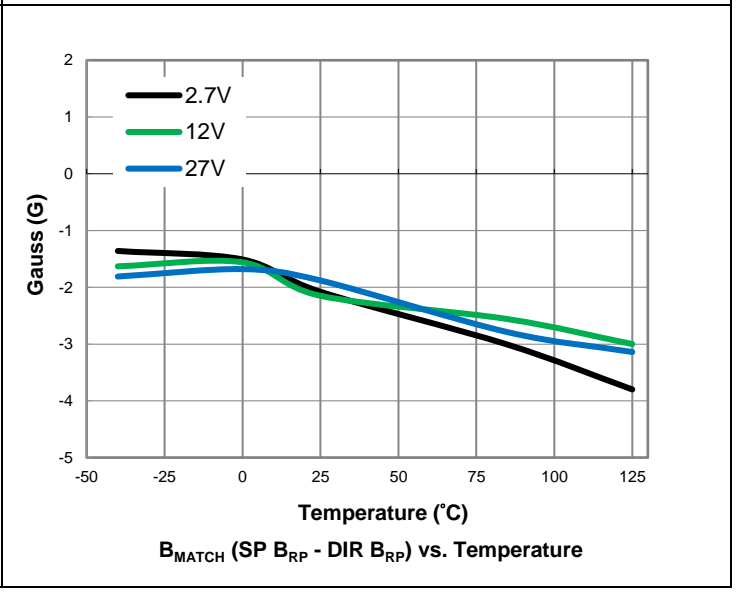
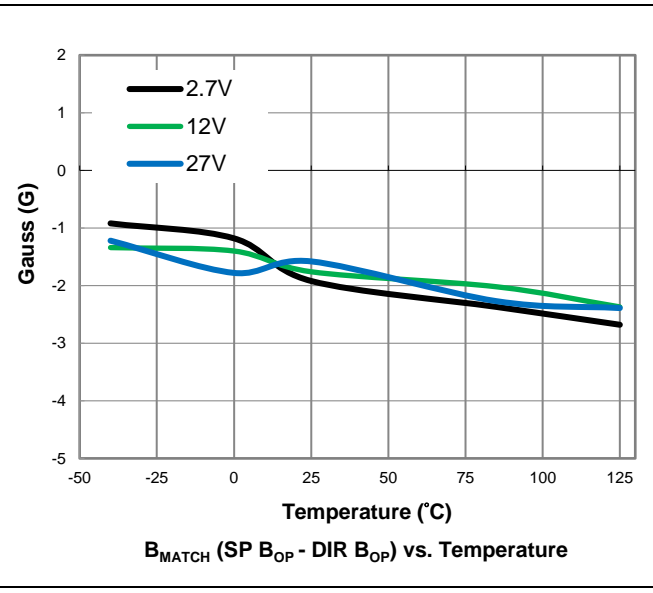
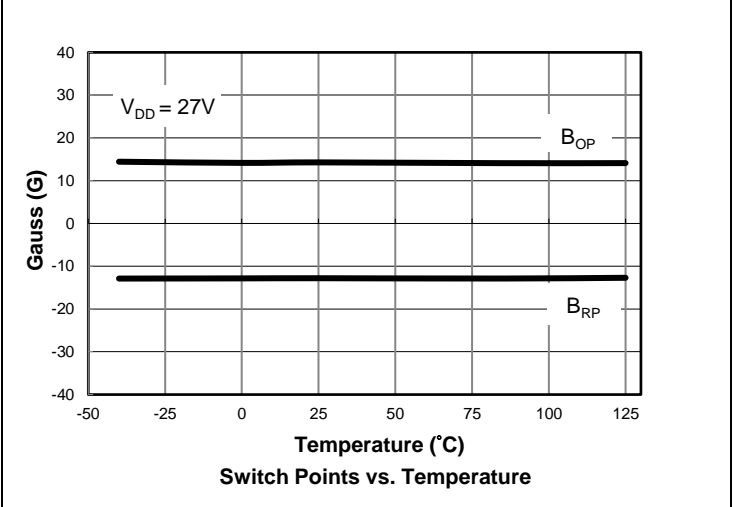
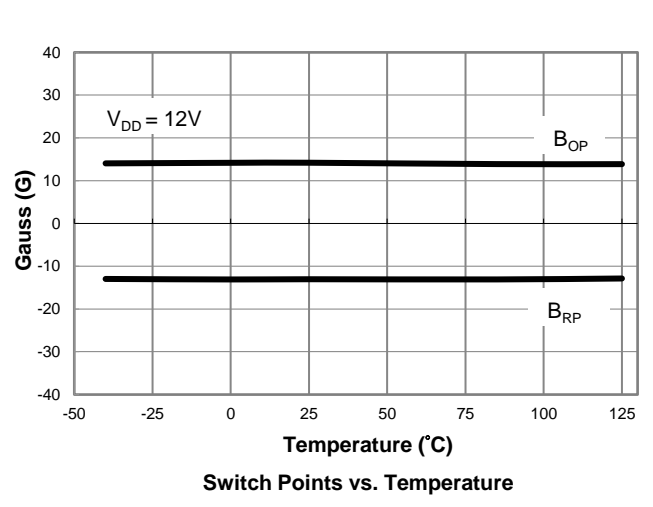
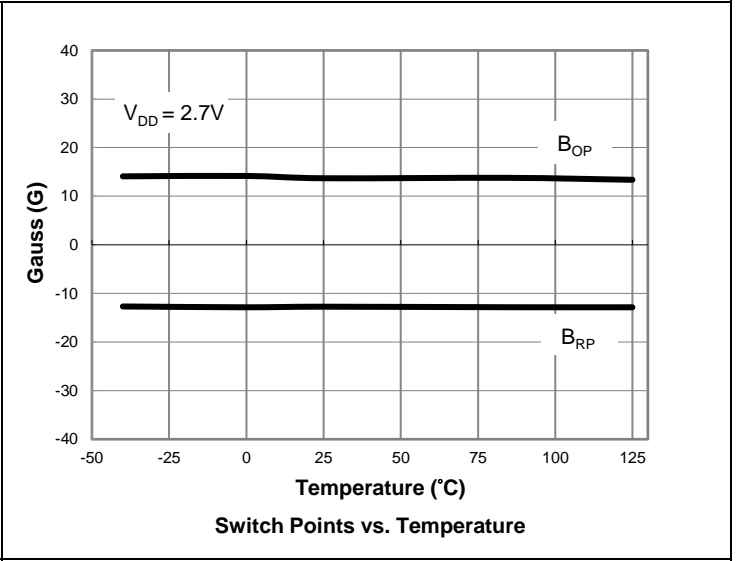
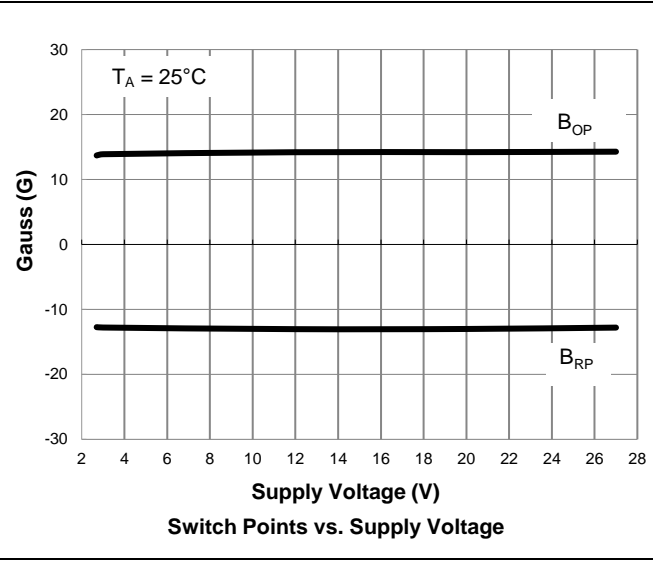

**Performance Characteristics** (continued)

**AH3965 Magnetic Characteristics** (continued)

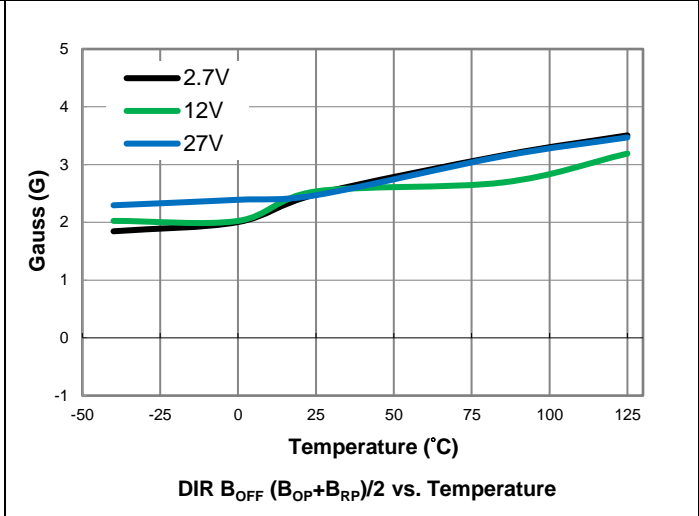
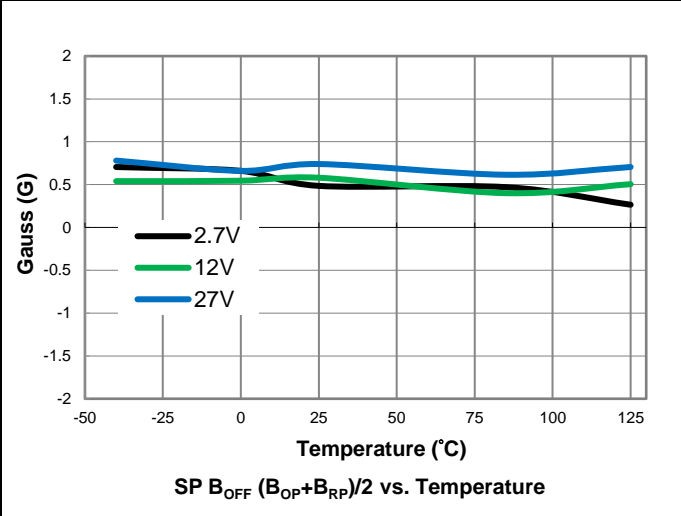

**AH3966 Magnetic Characteristics**

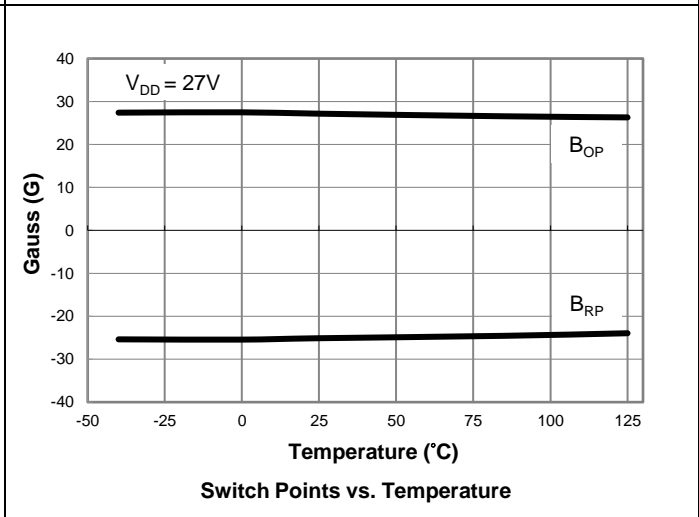
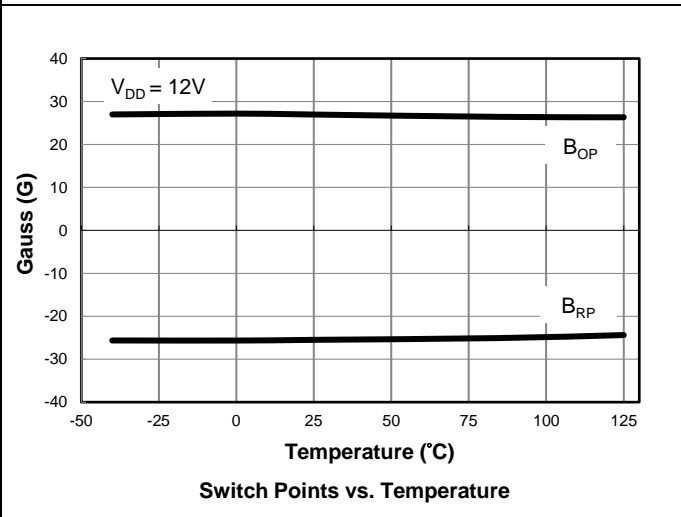
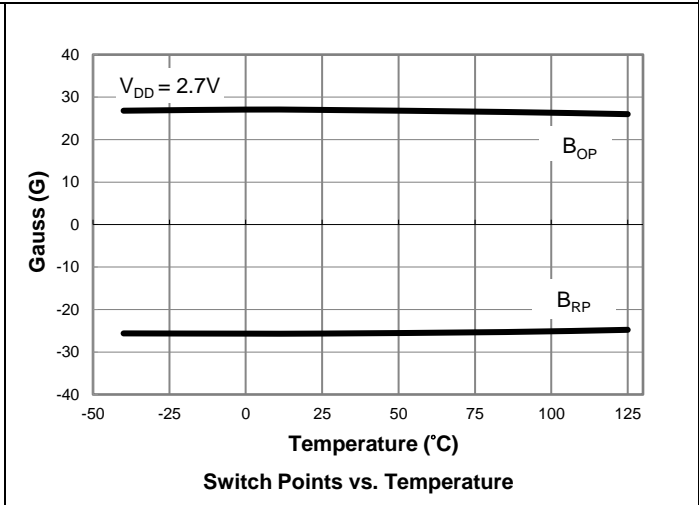
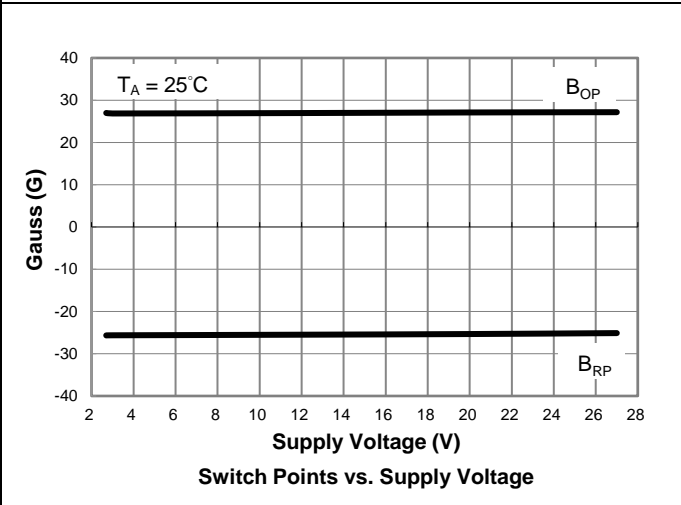

**Performance Characteristics** (continued)

**AH3966 Magnetic Characteristics** (continued)

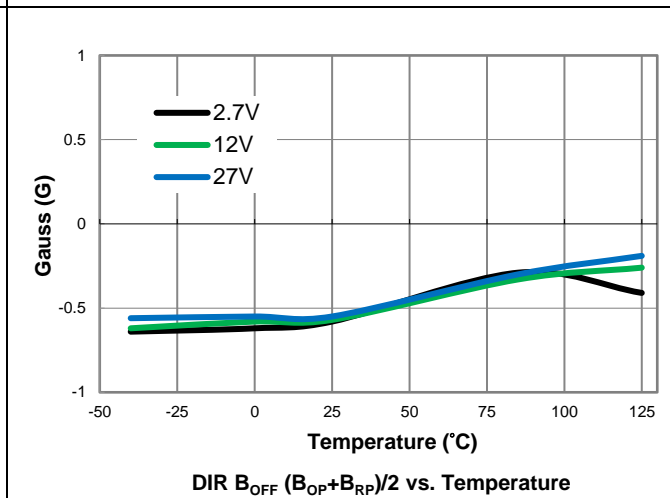
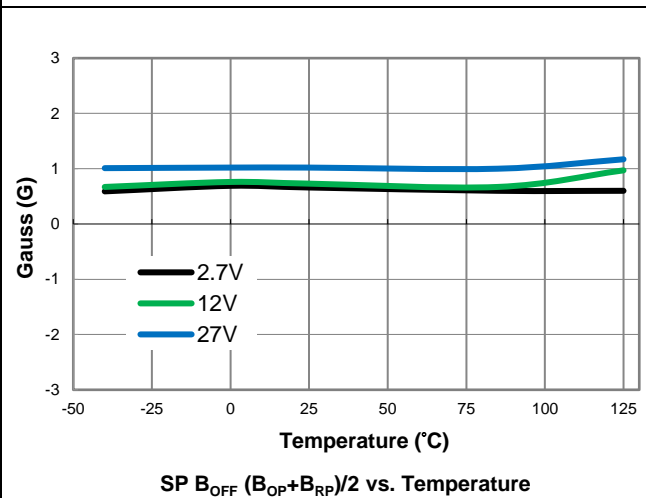
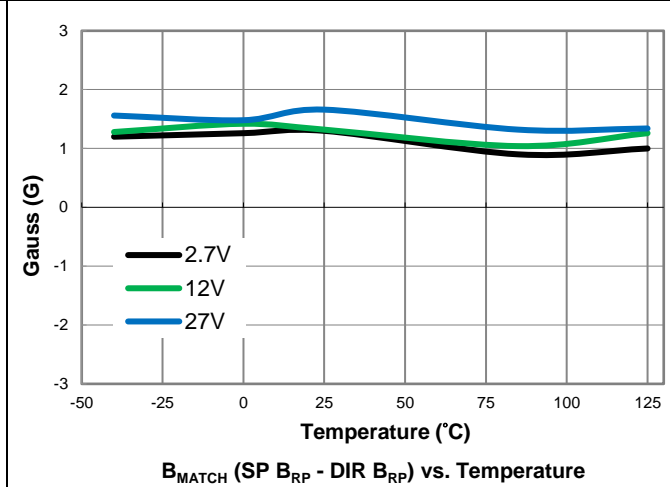
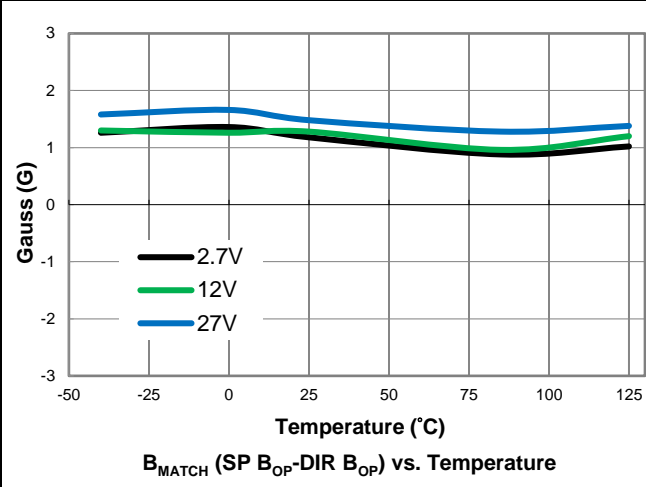

**AH3967 Magnetic Characteristics**

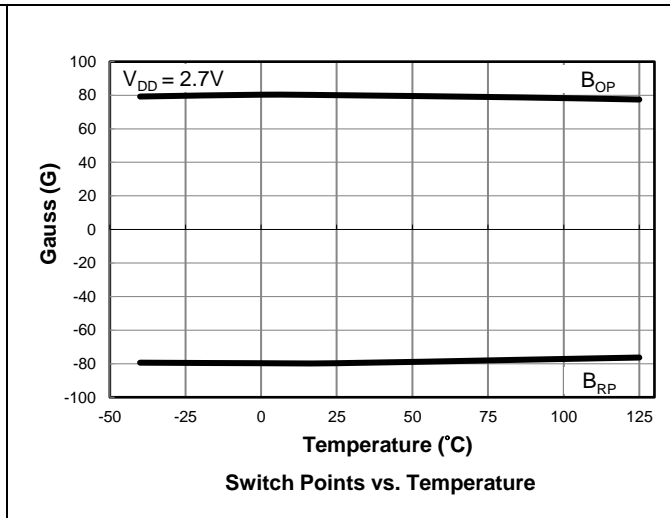
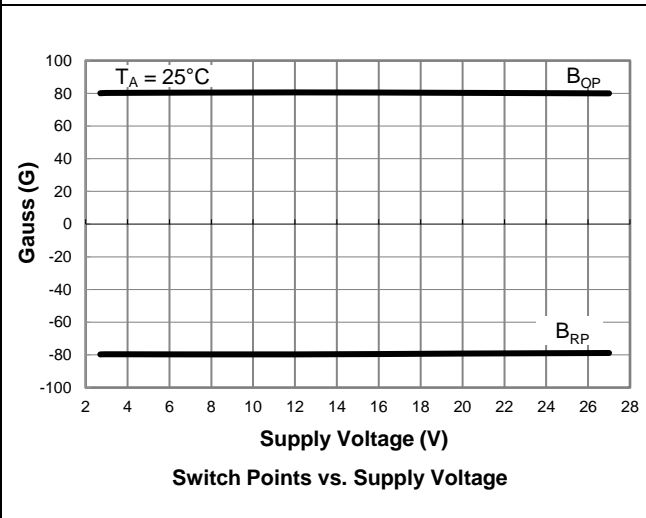

**Performance Characteristics** (continued)

**AH3967 Magnetic Characteristics** (continued)

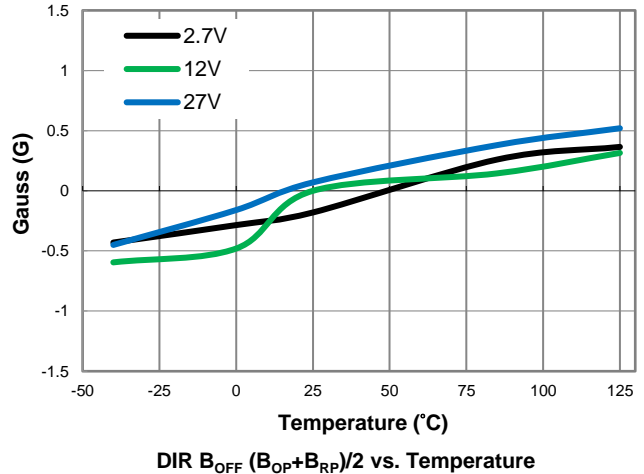
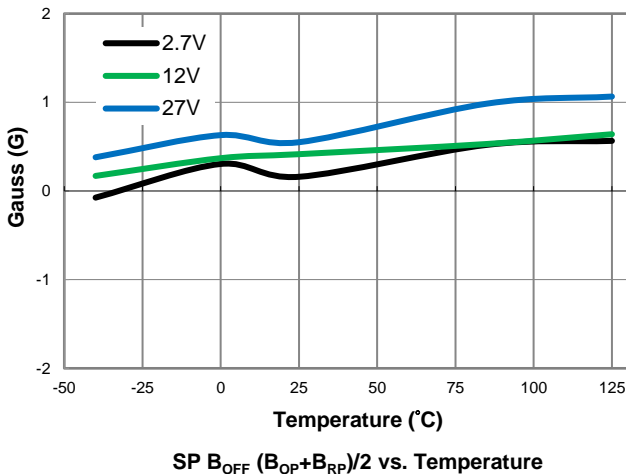
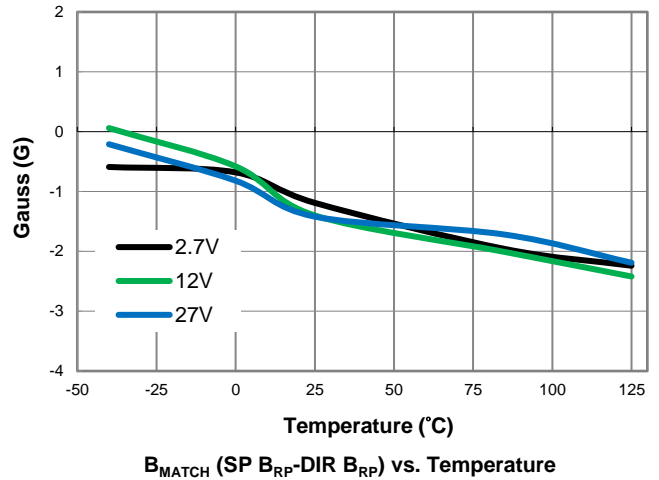
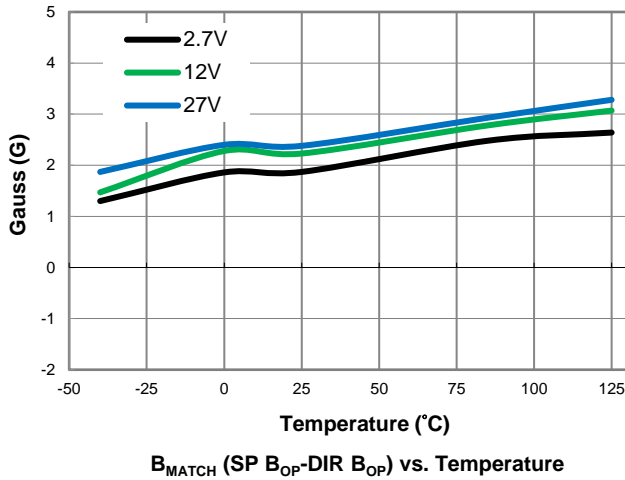
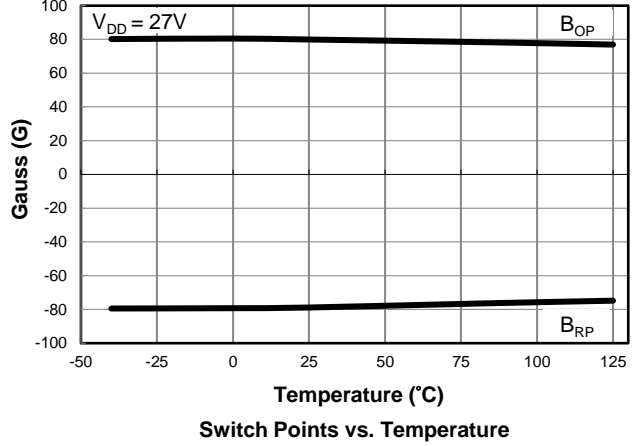
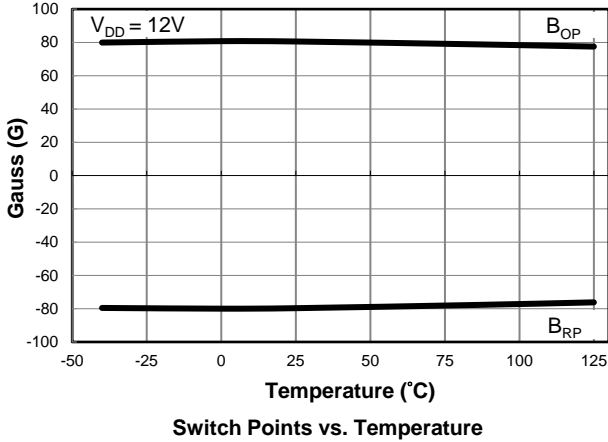

**Performance Characteristics** (continued)

**AH3968 Magnetic Characteristics**

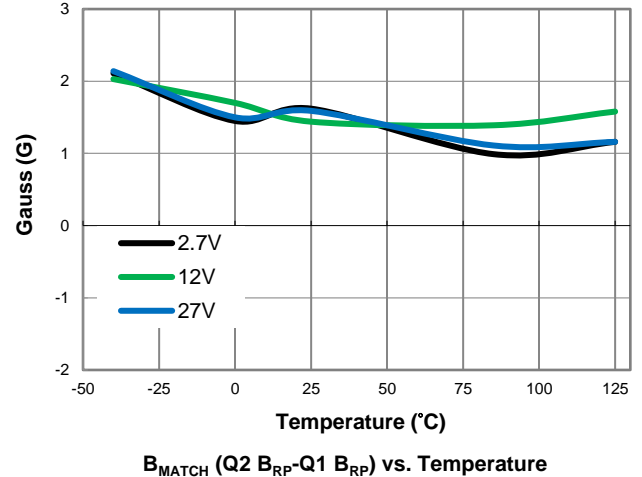
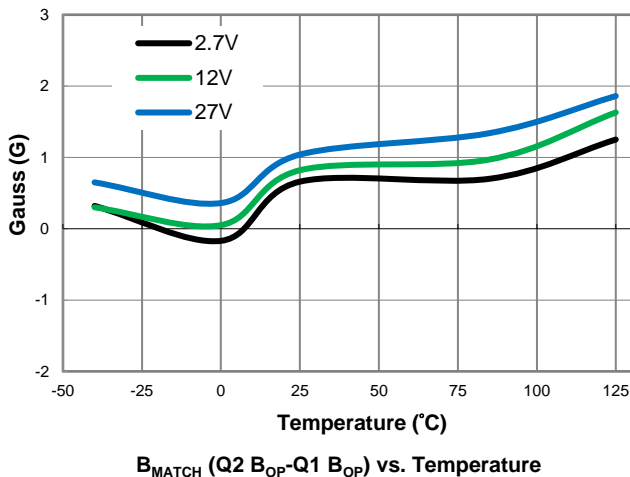
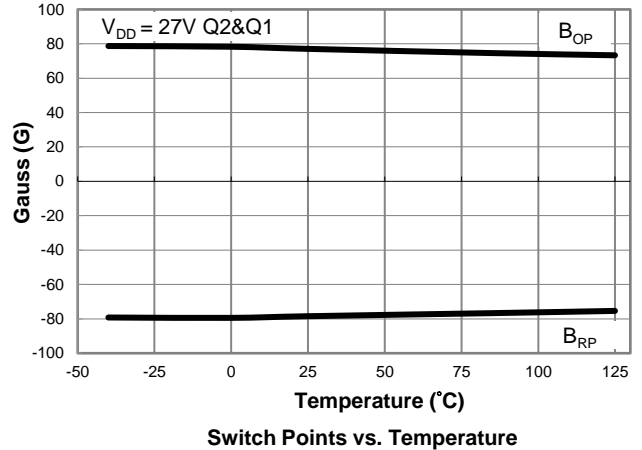
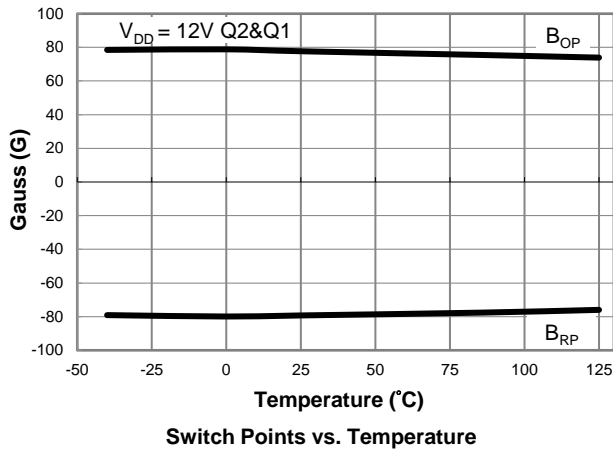
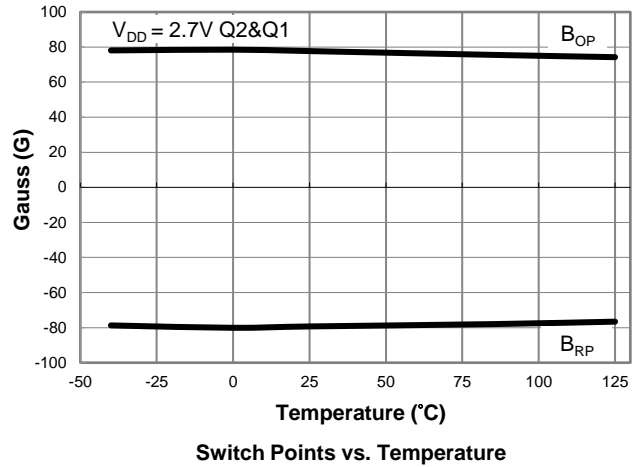
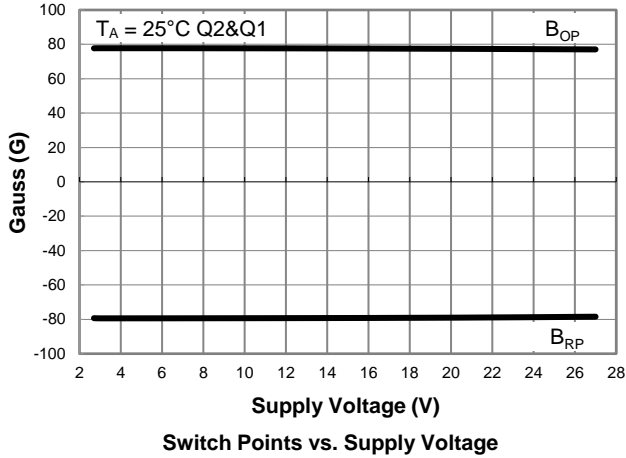

**Performance Characteristics** (continued)

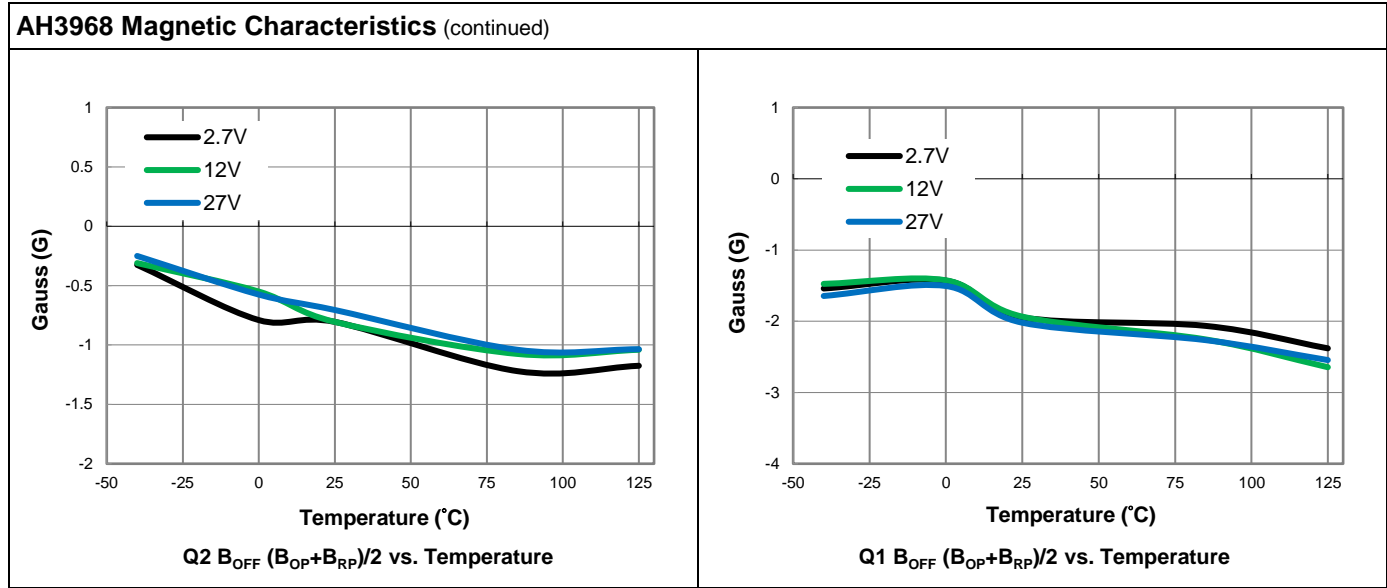

### Ordering Information

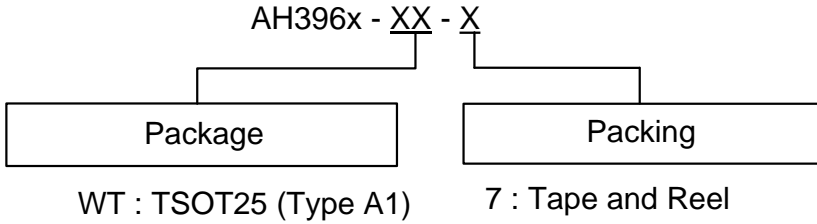

Part Number	Part Number Suffix	Package Code	Package	Packing	
				Qty.	Carrier
AH3965-WT-7	-7	WT	TSOT25 (Type A1)	3000	7" Tape and Reel
AH3966-WT-7	-7	WT	TSOT25 (Type A1)	3000	7" Tape and Reel
AH3967-WT-7	-7	WT	TSOT25 (Type A1)	3000	7" Tape and Reel
AH3968-WT-7	-7	WT	TSOT25 (Type A1)	3000	7" Tape and Reel

### Marking Information

Package Type: TSOT25 (Type A1)

(Top View)

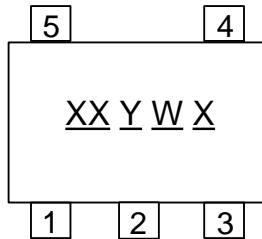

XX : Identification Code  
Y : Year 0 to 9 (ex: 3 = 2023)  
W : Week : A to Z : week 1 to 26;  
a to z : week 27 to 52; z represents week 52 and 53  
X : Internal Code

Part Number	Package	Identification Code
AH3965-WT-7	TSOT25 (Type A1)	M2
AH3966-WT-7	TSOT25 (Type A1)	M3
AH3967-WT-7	TSOT25 (Type A1)	M4
AH3968-WT-7	TSOT25 (Type A1)	M5

**Package Outline Dimensions**

Please see <http://www.diodes.com/package-outlines.html> for the latest version.

**TSOT25 (Type A1)**

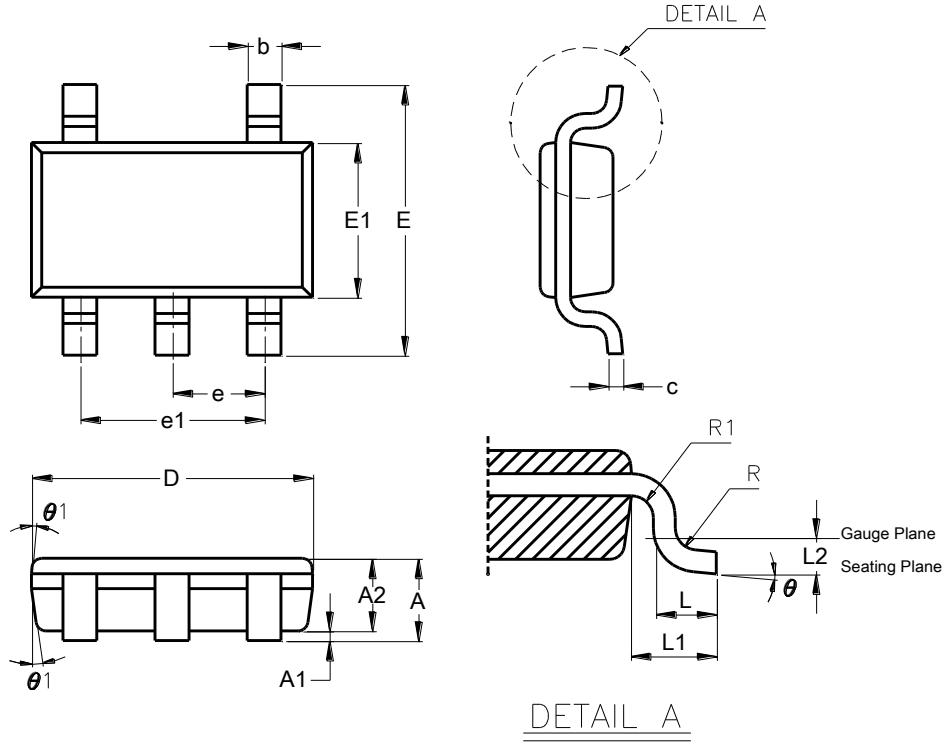

TSOT25 (Type A1)			
Dim	Min	Max	Typ
A	0.750	0.800	--
A1	0.00	0.050	--
A2	0.700	0.775	0.750
b	0.350	0.500	--
c	0.100	0.200	--
D	2.800	3.000	2.900
E	2.600	3.000	2.800
E1	1.500	1.700	1.600
e	0.950 BSC		
e1	1.900 BSC		
L	0.370	0.600	0.450
L1	0.600 REF		
L2	0.250 BSC		
R	0.100	--	--
R1	0.100	--	--
theta	0°	8°	4°
theta1	4°	12°	10°
<b>All Dimensions in mm</b>			

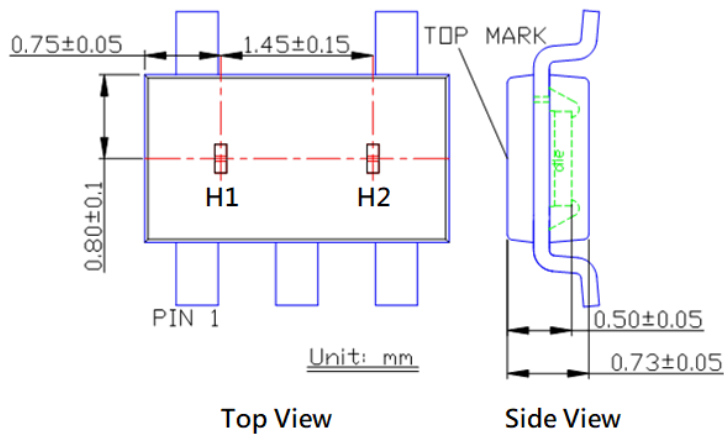

**Sensor Location**



**Suggested Pad Layout**

Please see <http://www.diodes.com/package-outlines.html> for the latest version.

TSOT25 (Type A1)

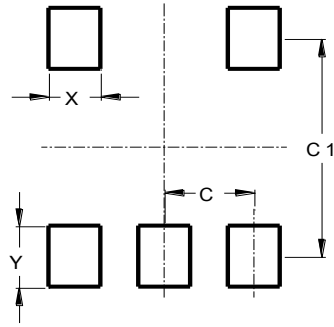

Dimensions	Value (in mm)
C	0.95
C1	2.50
X	0.55
Y	0.70

**Mechanical Data**

- Moisture Sensitivity: Level 1 per J-STD-020
- Terminals: Finish – Matte Tin Plated Leads, Solderable per MIL-STD-202, Method 208 (G3)
- Weight: 0.016 grams (Approximate)

**IMPORTANT NOTICE**

1. DIODES INCORPORATED (Diodes) AND ITS SUBSIDIARIES MAKE NO WARRANTY OF ANY KIND, EXPRESS OR IMPLIED, WITH REGARDS TO ANY INFORMATION CONTAINED IN THIS DOCUMENT, INCLUDING, BUT NOT LIMITED TO, THE IMPLIED WARRANTIES OF MERCHANTABILITY, FITNESS FOR A PARTICULAR PURPOSE OR NON-INFRINGEMENT OF THIRD PARTY INTELLECTUAL PROPERTY RIGHTS (AND THEIR EQUIVALENTS UNDER THE LAWS OF ANY JURISDICTION).
2. The Information contained herein is for informational purpose only and is provided only to illustrate the operation of Diodes' products described herein and application examples. Diodes does not assume any liability arising out of the application or use of this document or any product described herein. This document is intended for skilled and technically trained engineering customers and users who design with Diodes' products. Diodes' products may be used to facilitate safety-related applications; however, in all instances customers and users are responsible for (a) selecting the appropriate Diodes products for their applications, (b) evaluating the suitability of Diodes' products for their intended applications, (c) ensuring their applications, which incorporate Diodes' products, comply the applicable legal and regulatory requirements as well as safety and functional-safety related standards, and (d) ensuring they design with appropriate safeguards (including testing, validation, quality control techniques, redundancy, malfunction prevention, and appropriate treatment for aging degradation) to minimize the risks associated with their applications.
3. Diodes assumes no liability for any application-related information, support, assistance or feedback that may be provided by Diodes from time to time. Any customer or user of this document or products described herein will assume all risks and liabilities associated with such use, and will hold Diodes and all companies whose products are represented herein or on Diodes' websites, harmless against all damages and liabilities.
4. Products described herein may be covered by one or more United States, international or foreign patents and pending patent applications. Product names and markings noted herein may also be covered by one or more United States, international or foreign trademarks and trademark applications. Diodes does not convey any license under any of its intellectual property rights or the rights of any third parties (including third parties whose products and services may be described in this document or on Diodes' website) under this document.
5. Diodes' products are provided subject to Diodes' Standard Terms and Conditions of Sale (<https://www.diodes.com/about/company/terms-and-conditions/terms-and-conditions-of-sales/>) or other applicable terms. This document does not alter or expand the applicable warranties provided by Diodes. Diodes does not warrant or accept any liability whatsoever in respect of any products purchased through unauthorized sales channel.
6. Diodes' products and technology may not be used for or incorporated into any products or systems whose manufacture, use or sale is prohibited under any applicable laws and regulations. Should customers or users use Diodes' products in contravention of any applicable laws or regulations, or for any unintended or unauthorized application, customers and users will (a) be solely responsible for any damages, losses or penalties arising in connection therewith or as a result thereof, and (b) indemnify and hold Diodes and its representatives and agents harmless against any and all claims, damages, expenses, and attorney fees arising out of, directly or indirectly, any claim relating to any noncompliance with the applicable laws and regulations, as well as any unintended or unauthorized application.
7. While efforts have been made to ensure the information contained in this document is accurate, complete and current, it may contain technical inaccuracies, omissions and typographical errors. Diodes does not warrant that information contained in this document is error-free and Diodes is under no obligation to update or otherwise correct this information. Notwithstanding the foregoing, Diodes reserves the right to make modifications, enhancements, improvements, corrections or other changes without further notice to this document and any product described herein. This document is written in English but may be translated into multiple languages for reference. Only the English version of this document is the final and determinative format released by Diodes.
8. Any unauthorized copying, modification, distribution, transmission, display or other use of this document (or any portion hereof) is prohibited. Diodes assumes no responsibility for any losses incurred by the customers or users or any third parties arising from any such unauthorized use.
9. This Notice may be periodically updated with the most recent version available at <https://www.diodes.com/about/company/terms-and-conditions/important-notice>

The Diodes logo is a registered trademark of Diodes Incorporated in the United States and other countries.  
All other trademarks are the property of their respective owners.  
© 2023 Diodes Incorporated. All Rights Reserved.

[www.diodes.com](http://www.diodes.com)