

Description

The AP3064 is a high efficiency boost controller with 4-string current sources for driving WLED backlight. It operates over a wide input voltage range from 4.5V to 33V.

The current of 4 strings are simply programmed from 20mA to 220mA with an external resistor. The current matching between each string is $\pm 1.5\%$ (Typ). Its operating frequency can be adjusted from 0.1MHz to 1MHz.

The AP3064 features cycle-by-cycle current limit, soft-start, under voltage lockout (UVLO) protection, programmable OVP, over temperature protection (OTP), open/short LED protection, V_{OUT} short/Schottky diode open protection and Schottky Diode short-circuit protection.

The AP3064 is available in SO-16 package.

Features

- Input Voltage Range: 4.5V to 33V
- Drives up to 4 Strings in Parallel, 220mA per String
- Programmable WLED Current from 20mA to 220mA
- Adjustable Operating Frequency: 100kHz to 1MHz
- String-to-string Current Matching Accuracy: $\pm 1.5\%$
- Built-in OCP, OTP, UVLO
- External PWM Dimming
- Open/Short LED Protection
- Programmable Soft-start
- Programmable OVP
- Schottky Diode/Inductor Short-circuit Protection
- V_{OUT} Short/Schottky Diode Open Protection
- **Totally Lead-Free & Fully RoHS Compliant (Notes 1 & 2)**
- **Halogen and Antimony Free. "Green" Device (Note 3)**

Notes:

1. No purposely added lead. Fully EU Directive 2002/95/EC (RoHS), 2011/65/EU (RoHS 2) & 2015/863/EU (RoHS 3) compliant.
2. See <https://www.diodes.com/quality/lead-free/> for more information about Diodes Incorporated's definitions of Halogen- and Antimony-free, "Green" and Lead-free.
3. Halogen- and Antimony-free "Green" products are defined as those which contain <900ppm bromine, <900ppm chlorine (<1500ppm total Br + Cl) and <1000ppm antimony compounds.

Pin Assignments

(Top View)

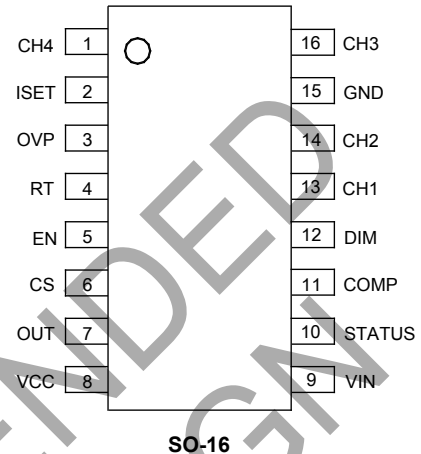

SO-16

Applications

- LCD Monitor
- LCD Display Module
- LCD TV

Typical Applications Circuit

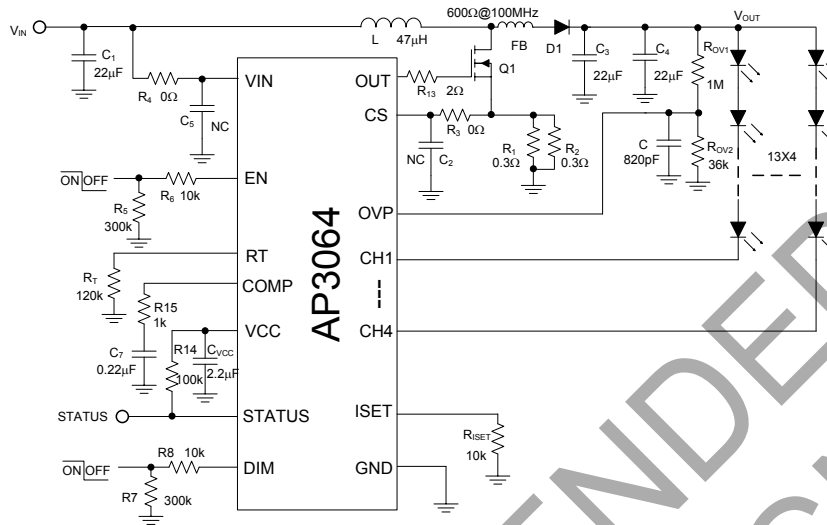

Pin Description

Pin Number	Pin Name	Function
1	CH4	LED current sink 4. Leave the pin open directly if not used
2	ISSET	LED current setting pin. The corresponding maximum current of all 4 strings is set through connecting a resistor from this pin to GND
3	OVP	Over voltage protection pin. When the OVP pin voltage exceeds 2.0V, the OVP is triggered and the power switch is turned off. When the OVP pin voltage drops below hysteresis voltage, the OVP is released and the power switch will resume normal operation
4	RT	Frequency control pin
5	EN	ON/OFF control pin. Forcing this pin above 2.4V enables the IC while below 0.5V shuts down the IC. When the IC is in shutdown mode, all functions are disabled to decrease the supply current below 3µA
6	CS	Power switch current sense input
7	OUT	Boost converter power switch gate output. This pin output high voltage (5V/V _{IN} -0.5V) to drive the external N-MOSFET
8	VCC	5V linear regulator output pin. This pin should be bypassed to GND (recommend to connect with GND pin) with a ceramic capacitor
9	VIN	Supply input pin. A capacitor (typical 10µF) should be connected between the V _{IN} and GND to keep the DC input voltage constant
10	STATUS	LED operation status output
11	COMP	Soft-start and control loop compensation
12	DIM	PWM dimming control pin. Adding a PWM signal to this pin to control LED dimming. If not used, connect it to the high level
13	CH1	LED current sink 1. Leave the pin open directly if not used
14	CH2	LED current sink 2. Leave the pin open directly if not used
15	GND	Ground
16	CH3	LED current sink 3. Leave the pin open directly if not used

Functional Block Diagram

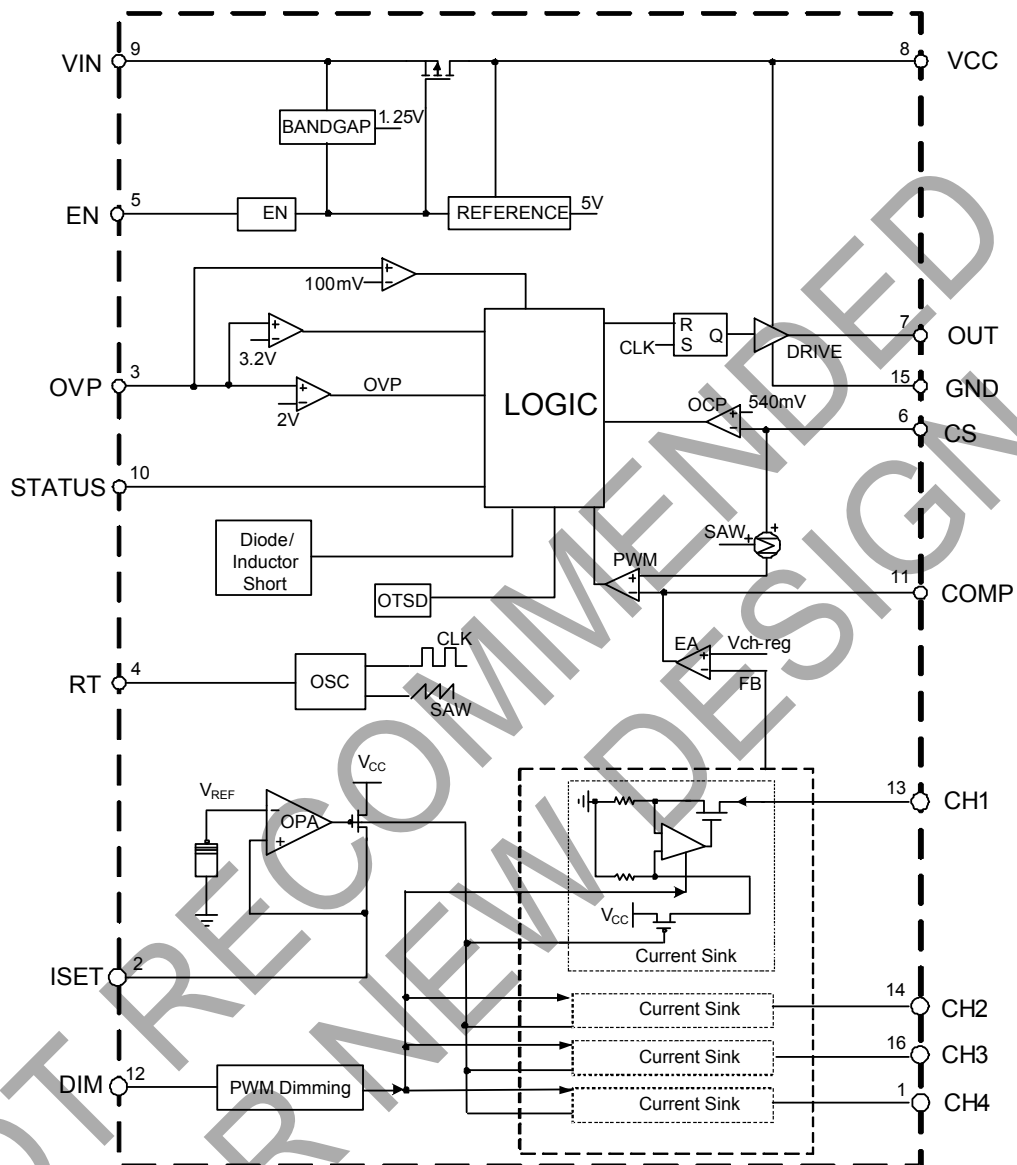

Absolute Maximum Ratings (Note 4)

Symbol	Parameter	Value	Unit
V _{IN}	Input Voltage	-0.3 to 42	V
V _{CH}	CH1 to CH4 Voltage	-0.3 to 65	V
V _{EN}	EN Pin Voltage	-0.3 to 7	V
V _{CC}	VCC Pin Voltage	-0.3 to 7	V
V _{CS}	CS Pin Voltage	-0.3 to 7 (Note 5)	V
V _{COMP}	COMP Pin Voltage	-0.3 to 7	V
V _{ISET}	ISET Pin Voltage	-0.3 to 7	V
V _{OUT}	OUT Pin Voltage	-0.3 to 7	V
V _{OVP}	OVP Pin Voltage	-0.3 to 7	V
V _{RT}	RT Pin Voltage	-0.3 to 7	V
V _{STATUS}	STATUS Pin Voltage	-0.3 to 7	V
V _{DIM}	DIM Pin Voltage	-0.3 to 7	V
V _{GND}	GND Pin Voltage	-0.3 to 0.3	V
θ _{JA}	Thermal Resistance (Junction to Ambient) (Note 6)	79	°C/W
θ _{JC}	Thermal Resistance (Junction to Case) (Note 6)	10	°C/W
T _J	Operating Junction Temperature	+150	°C
T _{STG}	Storage Temperature	-65 to +150	°C
T _{LEAD}	Lead Temperature (Soldering, 10sec)	+260	°C
—	ESD (Machine Model)	200	V
—	ESD (Human Body Model)	2000	V

Notes: 4. Stresses greater than those listed under "Absolute Maximum Ratings" may cause permanent damage to the device. These are stress ratings only, and functional operation of the device at these or any other conditions beyond those indicated under "Recommended Operating Conditions" is not implied. Exposure to "Absolute Maximum Ratings" for extended periods may affect device reliability.

5. Negative CS 100ns Transient maximum rating voltage reach to -0.4V.

6. Device mounted on 2"x2" FR-4 substrate PCB, 2oz copper, with minimum recommended pad layout.

Recommended Operating Conditions

Symbol	Parameter	Min	Max	Unit
V _{IN}	Input Voltage	4.5	33	V
f _O	Operating Frequency	0.1	1	MHz
V _{CHX}	LED Channel Voltage	—	60	V
I _{CHX}	LED Channel Current	20	220	mA
f _{PWM}	PWM Dimming Frequency	0.1	20	kHz
T _A	Operating Ambient Temperature Range	-40	+85	°C

Electrical Characteristics ($V_{IN} = 24V$, $V_{EN} = 5V$, Typical $T_A = +25^\circ C$, unless otherwise specified.)

Symbol	Parameter	Conditions	Min	Typ	Max	Unit
INPUT SUPPLY						
V_{IN}	Input Voltage	—	4.5	—	33	V
I_Q	Quiescent Current	No Switching	—	3	5	mA
I_{SHTD}	Shutdown Supply Current	$V_{EN} = V_{DD} = 0V$	—	0.1	3	μA
V_{UVLO}	UVLO	V_{IN} Rising	3.6	3.8	4.0	V
V_{HYS}	UVLO Hysteresis	—	—	200	—	mV
VCC SECTION						
V_{CC}	VCC Voltage	$V_{IN} \geq 5.5V$	—	5	—	V
		$V_{IN} < 5.5V$, Load = 10mA	—	$V_{IN}-0.1$	—	V
t_{RISING}	OUT Pin Rising Time (Note 7)	1nF Load	—	30	50	ns
$t_{FALLING}$	OUT Pin Falling Time (Note 7)	1nF Load	—	30	50	ns
—	Load Regulation (Note 7)	Load = 0 to 30mA	—	5	—	mV/mA
—	Line Regulation (Note 7)	$V_{IN} = 5.5$ to 24V	—	0.3	—	mV/V
HIGH FREQUENCY OSCILLATOR						
f_{OSC}	Switch Frequency (Target: 10% Variation)	$R_T = 100k\Omega$	440	520	600	kHz
—	Switch Frequency Range	—	0.1	—	1	MHz
D_{MAX}	Maximum Duty Cycle	$f = 500kHz$	88	90	—	%
$t_{ON-TIME}$	Minimum On-time (Note 7)	$f = 500kHz$	—	200	—	ns
ENABLE LOGIC AND DIMMING LOGIC						
V_{EN_H}	EN High Voltage	—	2.4	—	—	V
V_{EN_L}	EN Low Voltage	—	—	—	0.5	V
V_{DIM_H}	PWM Logic for External Dimming	—	2.5	—	—	V
V_{DIM_L}		—	—	—	0.3	V
t_{PWM_MIN}	PWM Dimming Minimum Pulse Width (Note 7)	—	—	$3/f_{osc}$	—	μs
POWER SWITCH DRIVE						
V_{LIMIT}	Current Limit Threshold Voltage	—	480	540	600	mV
V_{LIMIT2}	D/L Short Threshold Voltage	—	720	800	880	mV
t_{LEB}	Current Sense LEB Time (Note 7)	—	80	100	150	ns
COMPENSATION AND SOFT START (COMP PIN)						
G_{EA}	Error Amplifier Trans-conductance	—	—	2300	—	$\mu A/V$
I_{O_H}	Sourcing Current	$V_{COMP} = 0.5V$	80	120	160	μA
I_{O_L}	Sinking Current	$V_{COMP} = 2V$	80	120	160	μA

Note: 7. Guaranteed by design.

Electrical Characteristics (Cont. $V_{IN} = 24V$, $V_{EN} = 5V$, Typical $T_A = +25^\circ C$, unless otherwise specified.)

Symbol	Parameter	Conditions	Min	Typ	Max	Unit
OVER-VOLTAGE PROTECTION						
V_{OVP}	OVP Threshold Voltage	V_{OUT} Rising	1.9	2.0	2.1	V
V_{OVP_HYS}	OVP Hysteresis	—	—	250	—	mV
V_{OVP_SH}	Shutdown Under Abnormal Condition	—	3.0	3.2	3.4	V
CURRENT SOURCE						
I_{CH_MATCH}	LED Current Matching between Each String (Note 8)	$I_{CH} = 100mA$	—	1.5	4	%
I_{CH}	Regulation Current per Channel	$R_{ISET} = 12k\Omega$	92	100	108	mA
V_{LED_REG}	Minimum LED Regulation Voltage	$I_{CHX} = 100mA$	—	230	—	mV
I_{LED_LEAK}	CH1 to CH4 Leakage Current	$V_{EN} = 0V$, $V_{LED} = 37V$	—	0.1	1	μA
V_{LED_S}	LED Short Protection Threshold	—	6.6	7.3	8.0	V
OVER-TEMPERATURE PROTECTION						
T_{OTSD}	Thermal Shutdown Temperature (Note 7)	—	—	+160	—	$^\circ C$
T_{HYS}	Thermal Shutdown Recovery (Note 7)	—	—	+140	—	$^\circ C$

Notes: 7. Guaranteed by design.

$$8. I_{ST_MATCH} = \frac{I_{MAX} - I_{MIN}}{2 \times I_{AVG}} \times 100\%$$

NOT RECOMMENDED FOR NEW DESIGN

Performance Characteristics ($V_{IN} = 24V$, $V_{EN} = V_{DD} = 5V$, 13 LEDs in series, 4 strings in parallel, 120mA/string, $T_A = +25^\circ C$, unless otherwise specified.)

Frequency vs. R_T

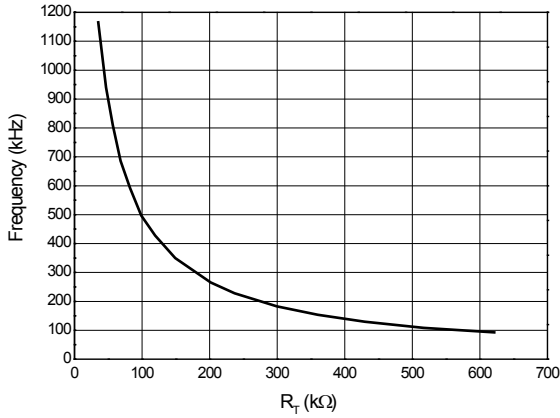

VCC Voltage vs. Input Voltage

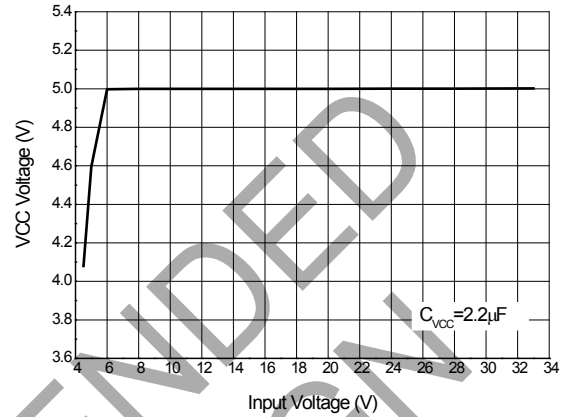

V_{CH} Regulation Voltage vs. Output Current

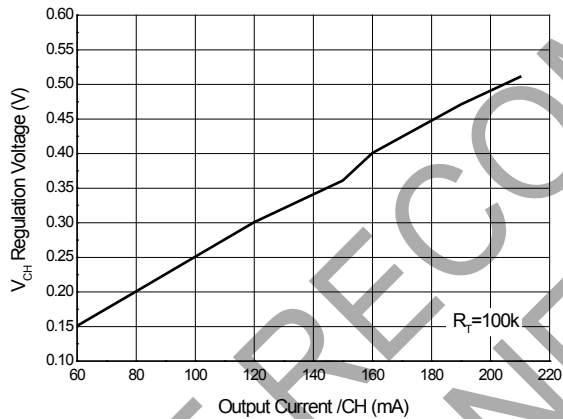

V_{CH} Regulation Voltage vs. Temperature

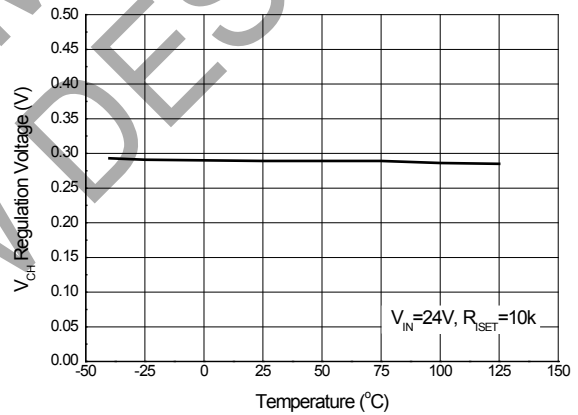

Channel Current vs. Channel

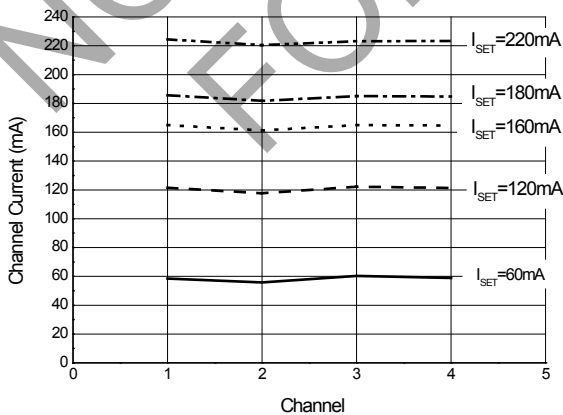

Efficiency vs. Output Current

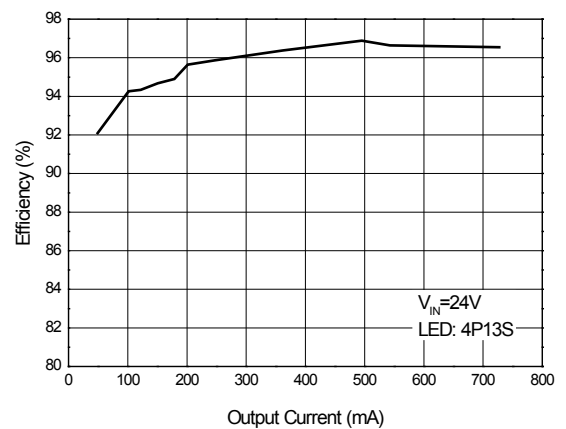

Performance Characteristics (Cont. $V_{IN} = 24V$, $V_{EN} = V_{DD} = 5V$, 13 LEDs in series, 4 strings in parallel, 120mA/string, $T_A = +25^\circ C$, unless otherwise specified.)

Steady State

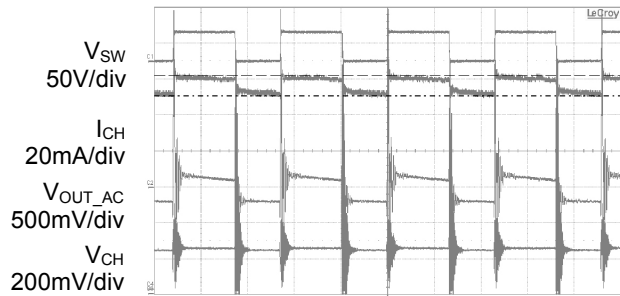

Time 1 μ s/div

System Startup

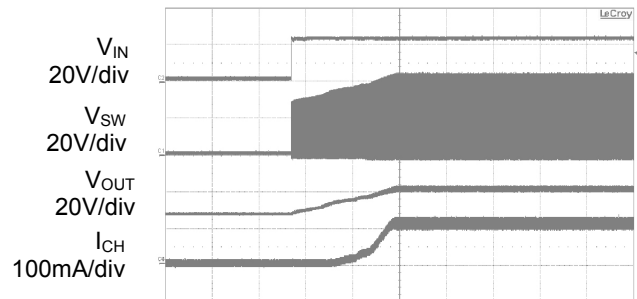

Time 20ms/div

PWM Dimming

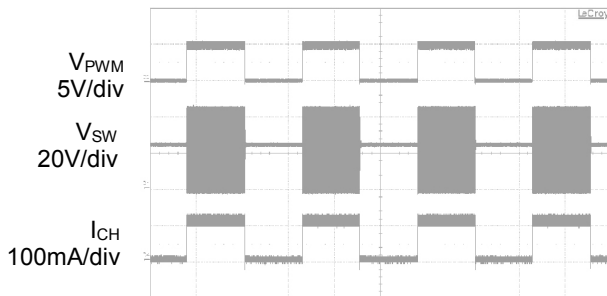

Time 2ms/div

LED Short Protection

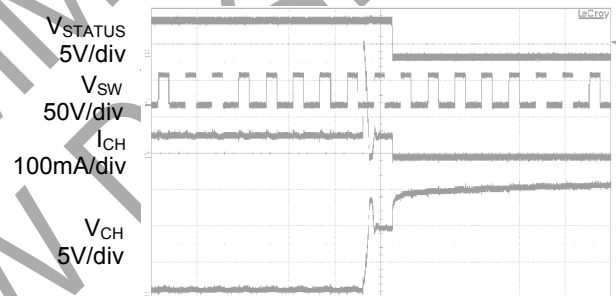

Time 10 μ s/div

LED Open Protection

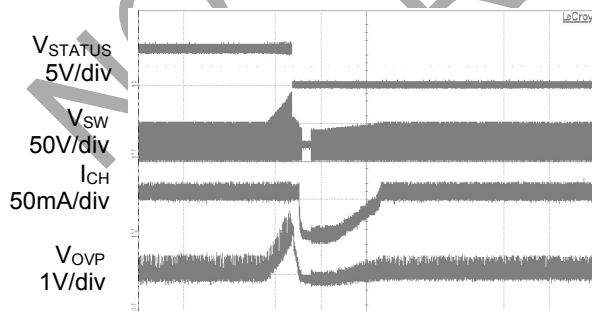

Time 50ms/div

Schottky/Inductor Short Protection

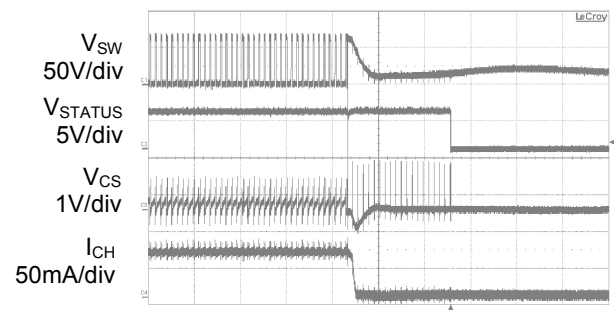

Time 50 μ s/div

Performance Characteristics (Cont. $V_{IN} = 24V$, $V_{EN} = V_{DD} = 5V$, 13 LEDs in series, 4 strings in parallel, 120mA/string, $T_A = +25^\circ C$, unless otherwise specified.)

V_{OUT} Short/Diode Open Protection

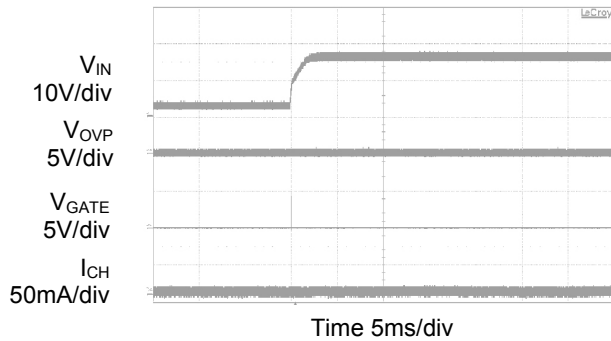

Over Temperature Protection

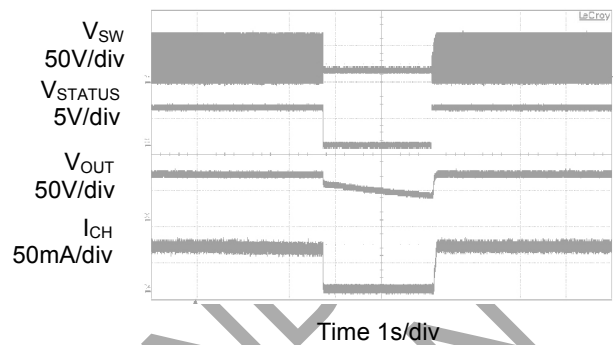

Application Information

1. Enable

The AP3064 is enabled when the voltage to EN is greater than approximately 2.4V, disabled when lower than 0.5V.

2. Frequency Selection

An external resistor R_T , placed between RT pin and GND, can be used to set the operating frequency. The operating frequency ranges from 100kHz to 1MHz. The high frequency operation optimizes the regulator for the smallest-sized component application, while low frequency operation can help to reduce switch loss. The approximate operating frequency can be expressed as below:

$$f_{OSC} [MHz] = \frac{52}{R_{RT} [K\Omega]}$$

3. LED Current Setting

The maximum LED current per channel can be adjusted up to 180mA via ISET pin. When $\geq 180mA$ current is needed in application, two or more channels can be paralleled to provide larger drive current. Connect a resistor R_{ISET} between ISET pin and GND to set the reference current I_{SET} . The LED current can be expressed as below:

$$I_{LED} [mA] = \frac{1200}{R_{ISET} [K\Omega]}$$

4. Dimming Control

Applying a PWM signal to DIM pin to adjust the LED current, that means, the LED current of all enabled channels can be adjusted at the same time and the LED brightness can be adjusted from $1\% \times I_{CHX_MAX}$ to $100\% \times I_{CHX_MAX}$. During the "high level" period of PWM signal, the LED is turned on and 100% of the current flows through LED, while during the "low level" period of the PWM signal, the LED is turned off and almost no current flows through the LED, thus changing the average current through LED and finally adjusting LED brightness. The external PWM signal frequency applied to DIM pin is allowed to be 100Hz or higher.

5. Status Output

After IC is enabled, STATUS will output logic low if any of the following conditions exists:

- (1) Any String is Open
- (2) LED Short Circuit Protection
- (3) Shut Down Under Abnormal Condition
- (4) Over Voltage Protection

Application Information (Cont.)

- (5) Over Temperature Protection
- (6) Schottky Diode Short Protection
- (7) V_{OUT} Short/Open Schottky Diode Protection

6. Over Voltage Protection

The AP3064 integrates an OVP circuit. The OVP pin is connected to the center tap of voltage-divider (R_{OV1} and R_{OV2}) that placed between high voltage output and GND. If the voltage on OVP pin exceeds 2.0V, which may results from open loop or excessive output voltage, all the functions of AP3064 will be disabled with output voltage falling. The OVP hysteresis is 250mV. The formulas of OVP can be expressed as below:

$$V_{OVP} = \frac{(R_{OV1} + R_{OV2}) \times 2.0V}{R_{OV2}}$$

7. Over Current Protection

The AP3064 integrates an OCP circuit. The CS pin is connected to the voltage-sensor (R_{CS}) that placed between the Drain of MOS and GND. If the voltage on CS pin exceeds 0.54V, it is turned off immediately and will not turn on until the next cycle begins.

8. LED Short-Circuit Protection

The AP3064 integrates an LED Short-circuit protection circuit. If the voltage at any of the CH1-4 pins exceeds a threshold of approximately 7.3V during normal operation, the corresponding string is turned off and is latched off. Toggle V_{IN} and/or EN to reset the latch. LED short detecting logic priority is lower than open LED and OVP logic. The LED short detecting is triggered when $0.1V < V_{LED_MIN}$ under dimming on mode, disabled when LED open occurs until output voltage resumes to the regulated voltage.

9. LED Open-circuit Protection

The AP3064 integrates an LED Open-circuit Protection circuit. When any LED string is open, V_{OUT} will boost up until the voltage at OVP pin reaches an approximate 2.0V threshold. The IC will automatically ignore the open string whose corresponding pin voltage is less than 100mV and the remaining string will continue operation. If all the strings are open and the voltage at OVP reaches a threshold of 2.0V, the MOSFET drive GATE will turn off and IC will shut down and latch.

10. V_{OUT} Short / Open Schottky Diode Protection

The AP3064 monitors the OVP pin, if the OVP pin voltage is less than 0.1V, MOSFET drive output will turn off. This protects the converter if the output Schottky diode is open or V_{OUT} is shorted to ground.

11. Under Voltage Lockout

The AP3064 provides an under voltage lockout circuit to prevent it from undefined status when startup. The UVLO circuit shuts down the device when V_{CC} drops below 3.6V. The UVLO circuit has 200mV hysteresis, which means the device starts up again when V_{CC} rise to 3.8V.

12. Over Temperature Protection

The AP3064 features Over Temperature Protection, if the junction temperature exceeds approximately +160°C, the IC will shut down until the junction temperature is less than approximately +140°C. When the IC is released from over temperature shutdown, it will start a soft-start process.

13. Schottky Diode/Inductor Short Circuit Protection

The AP3064 features Schottky diode/inductor short-circuit protection circuit. When CS pin voltage exceeds 0.8V for greater than 16 switching clocks, the IC will latch. The voltage of CS is monitored after a short delay of LEB.

14. Shut Down under Abnormal Condition

The AP3064 features shutdown under abnormal condition protection circuit. When OVP pin voltage exceeds 3.2V, the IC will latch. Toggle EN to restart the IC. This feature can be used for any other protection to shut down the IC.

Ordering Information

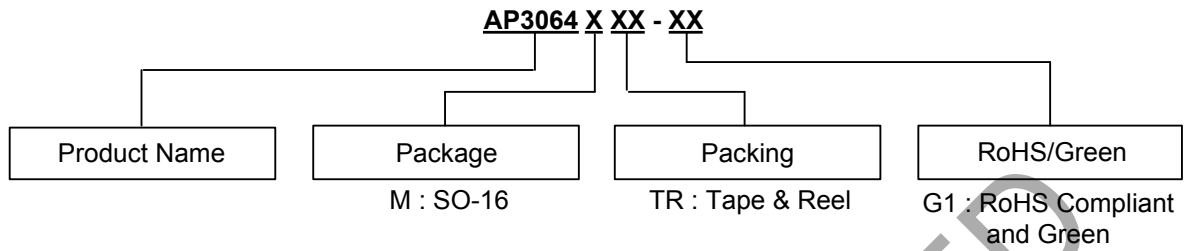

Package	Temperature Range	Part Number	Marking ID	Packing
SO-16	-40 to +85°C	AP3064MTR-G1	AP3064M-G1	4000/13" Tape & Reel

Marking Information

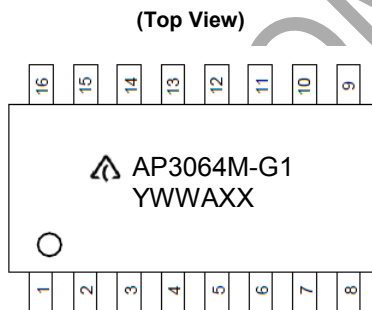

First Line: Logo and Marking ID
 Second Line: Date Code
 Y: Year
 WW: Work Week of Molding
 A: Assembly House Code
 XX: 7th and 8th Digits of Batch Number

Package Outline Dimensions

Please see <http://www.diodes.com/package-outlines.html> for the latest version.

SO-16

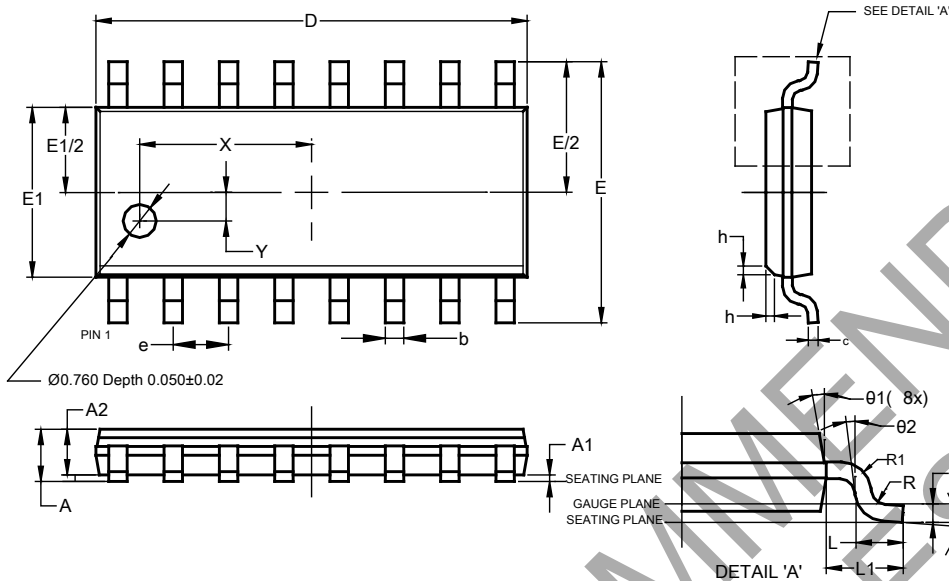

SO-16			
Dim	Min	Max	Typ
A	--	1.260	--
A1	0.10	0.23	--
A2	1.02	--	--
b	0.31	0.51	--
c	0.10	0.25	--
D	9.80	10.00	--
E	5.90	6.10	--
E1	3.80	4.00	--
e	1.27 BSC		
h	0.15	0.25	0.20
L	0.40	1.27	--
L1	1.04 REF		
L2	0.25 BSC		
R	0.07	--	--
R1	0.07	--	--
X	3.945 REF		
Y	0.661 REF		
θ	0°	8°	--
θ1	5°	15°	--
θ2	0°	--	--
All Dimensions in mm			

Suggested Pad Layout

Please see <http://www.diodes.com/package-outlines.html> for the latest version.

SO-16

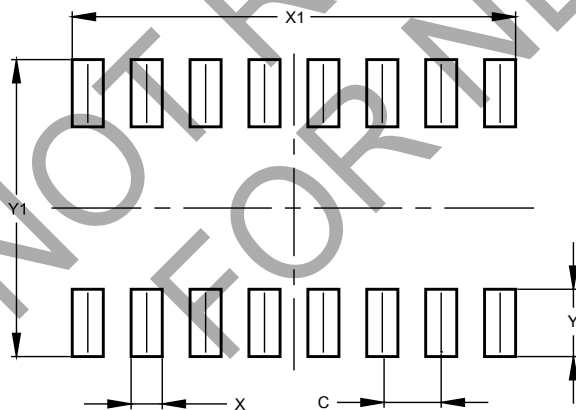

Dimensions	Value (in mm)
C	1.270
X	0.670
X1	9.560
Y	1.450
Y1	6.400

IMPORTANT NOTICE

1. DIODES INCORPORATED AND ITS SUBSIDIARIES (“DIODES”) MAKE NO WARRANTY OF ANY KIND, EXPRESS OR IMPLIED, WITH REGARDS TO ANY INFORMATION CONTAINED IN THIS DOCUMENT, INCLUDING, BUT NOT LIMITED TO, THE IMPLIED WARRANTIES OF MERCHANTABILITY, FITNESS FOR A PARTICULAR PURPOSE OR NON-INFRINGEMENT OF THIRD PARTY INTELLECTUAL PROPERTY RIGHTS (AND THEIR EQUIVALENTS UNDER THE LAWS OF ANY JURISDICTION).
2. The Information contained herein is for informational purpose only and is provided only to illustrate the operation of Diodes products described herein and application examples. Diodes does not assume any liability arising out of the application or use of this document or any product described herein. This document is intended for skilled and technically trained engineering customers and users who design with Diodes products. Diodes products may be used to facilitate safety-related applications; however, in all instances customers and users are responsible for (a) selecting the appropriate Diodes products for their applications, (b) evaluating the suitability of the Diodes products for their intended applications, (c) ensuring their applications, which incorporate Diodes products, comply the applicable legal and regulatory requirements as well as safety and functional-safety related standards, and (d) ensuring they design with appropriate safeguards (including testing, validation, quality control techniques, redundancy, malfunction prevention, and appropriate treatment for aging degradation) to minimize the risks associated with their applications.
3. Diodes assumes no liability for any application-related information, support, assistance or feedback that may be provided by Diodes from time to time. Any customer or user of this document or products described herein will assume all risks and liabilities associated with such use, and will hold Diodes and all companies whose products are represented herein or on Diodes’ websites, harmless against all damages and liabilities.
4. Products described herein may be covered by one or more United States, international or foreign patents and pending patent applications. Product names and markings noted herein may also be covered by one or more United States, international or foreign trademarks and trademark applications. Diodes does not convey any license under any of its intellectual property rights or the rights of any third parties (including third parties whose products and services may be described in this document or on Diodes’ website) under this document.
5. Diodes products are provided subject to Diodes’ Standard Terms and Conditions of Sale (<https://www.diodes.com/about/company/terms-and-conditions/terms-and-conditions-of-sales/>) or other applicable terms. This document does not alter or expand the applicable warranties provided by Diodes. Diodes does not warrant or accept any liability whatsoever in respect of any products purchased through unauthorized sales channel.
6. Diodes products and technology may not be used for or incorporated into any products or systems whose manufacture, use or sale is prohibited under any applicable laws and regulations. Should customers or users use Diodes products in contravention of any applicable laws or regulations, or for any unintended or unauthorized application, customers and users will (a) be solely responsible for any damages, losses or penalties arising in connection therewith or as a result thereof, and (b) indemnify and hold Diodes and its representatives and agents harmless against any and all claims, damages, expenses, and attorney fees arising out of, directly or indirectly, any claim relating to any noncompliance with the applicable laws and regulations, as well as any unintended or unauthorized application.
7. While efforts have been made to ensure the information contained in this document is accurate, complete and current, it may contain technical inaccuracies, omissions and typographical errors. Diodes does not warrant that information contained in this document is error-free and Diodes is under no obligation to update or otherwise correct this information. Notwithstanding the foregoing, Diodes reserves the right to make modifications, enhancements, improvements, corrections or other changes without further notice to this document and any product described herein. This document is written in English but may be translated into multiple languages for reference. Only the English version of this document is the final and determinative format released by Diodes.
8. Any unauthorized copying, modification, distribution, transmission, display or other use of this document (or any portion hereof) is prohibited. Diodes assumes no responsibility for any losses incurred by the customers or users or any third parties arising from any such unauthorized use.

Copyright © 2021 Diodes Incorporated

www.diodes.com