

Description

The AP3616 is a sixteen-channel constant current sink with current match used for LED driver. It uses an external resistor to set the current for sixteen LED strings with an accuracy of $\pm 1.5\%$. The full scale LED current can be adjusted from 20mA to 75mA for each channel. The LED lightness can be adjusted by PWM dimming function.

The device can keep working normally without any damage when LEDs are short or open. It features undervoltage lockout protection and overtemperature protection.

The AP3616 has three interface terminals (FB, SYN and FBX pins). The FB and SYN pins allow the device to work with a DC/DC converter to drive LED arrays for good performance. And the FBX pin enables the device to be connected in parallel.

The AP3616 is available in SOIC-28 and HSOP-28 packages.

Features

- Input Voltage Range: 4.2V to 27V
- Maximum Output Current: Typical 1.2A (75mA per Channel)
- Current Match Accuracy (Typical): $\pm 1.5\%$
- PWM / Linear Dimming Control
- Open LED Self-check and Protection
- Flexible Short LED Protection
- Undervoltage Lockout Protection
- Overtemperature Protection
- FBX and SYN Pins Enable Parallel Application
- Overvoltage Protection
- **Totally Lead-Free & Fully RoHS Compliant (Notes 1 & 2)**
- **Halogen and Antimony Free. "Green" Device (Note 3)**

Applications

- LCD Display Modules
- LCD Monitor
- LCD TV

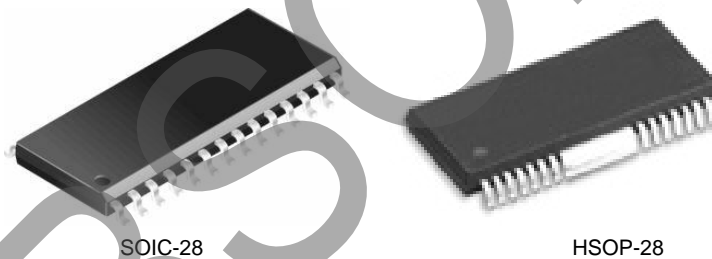
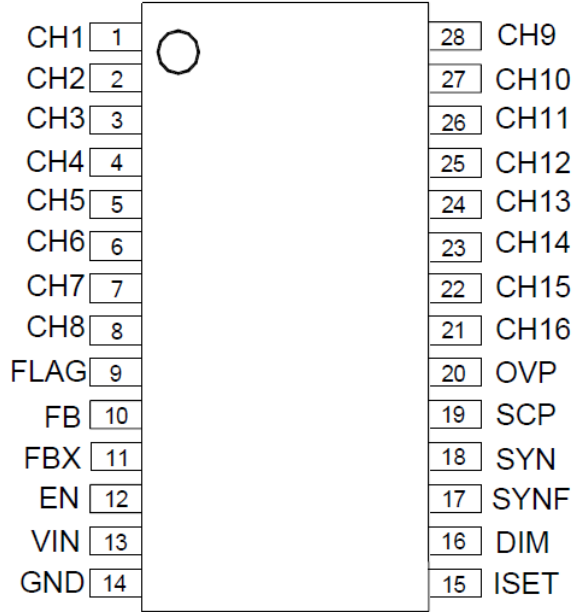

Figure 1. Package Types of AP3616

- Notes:
1. No purposely added lead. Fully EU Directive 2002/95/EC (RoHS), 2011/65/EU (RoHS 2) & 2015/863/EU (RoHS 3) compliant.
 2. See <https://www.diodes.com/quality/lead-free/> for more information about Diodes Incorporated's definitions of Halogen- and Antimony-free, "Green" and Lead-free.
 3. Halogen- and Antimony-free "Green" products are defined as those which contain <900ppm bromine, <900ppm chlorine (<1500ppm total Br + Cl) and <1000ppm antimony compounds.

Pin Configuration

M Package
(SOIC-28)



M28 Package
(HSOP-28)

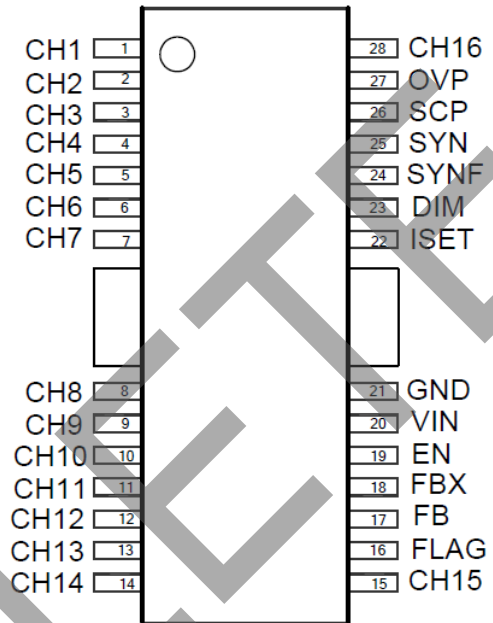

Figure 2. Pin Configuration of AP3616 (Top View)

OBSOLETE - PART DISCONTINUED

OBSOLETE

Pin Description

Pin Number		Pin Name	Function
SOIC-28	HSOP-28		
1 to 8 28 to 21	1 to 8 9 to 15 & 28	CH1 to CH8 CH9 to CH16	White LED cathode connection pins. If not used, leave them unconnected
9	16	FLAG	Error flag pin. When LED load goes to error (short or open), the flag open drain output will close
10	17	FB	Feedback pin. This pin is an interface terminal, which samples the voltage of each channel, and outputs the lowest voltage of the string to DC/DC converter
11	18	FBX	This pin is an interface terminal. Connect it to FB pin can achieve parallel application. If not used, leave it unconnected
12	19	EN	Enable pin. Logic high enables the IC and logic low disables the IC
13	20	VIN	Input voltage pin
14	21	GND	Ground pin
15	22	ISET	LED current setting pin. An external resistor is connected to this pin. Current on each channel can be expressed by $I_{CHANNEL} = 1.194 * 1560 / R_{ISET}$
16	23	DIM	Dimming control pin. Adding a PWM signal or DC signal to this pin to control LED dimming. Connect it to high-voltage level if not used
17	24	SYNF	Synchronous PWM frequency setting pin. A nF level of capacitor should be connected to this pin to set PWM frequency at about 80Hz to 25kHz
18	25	SYN	PWM dimming synchronous pin, this pin outputs DC transformed PWM signal to synchronize parallel AP3616 and power converter, if not used, leave it unconnected
19	26	SCP	LED short trigger voltage setting pin. This pin is used to set the LED short circuit protection voltage level
20	27	OVP	This pin is used to trigger OVP condition. OVP triggering voltage should be lower than the OVP voltage of its cascade chip, such as, AP3039A in Figure 19

OBSOLETE

Functional Block Diagram

OBSOLETE - PART DISCONTINUED

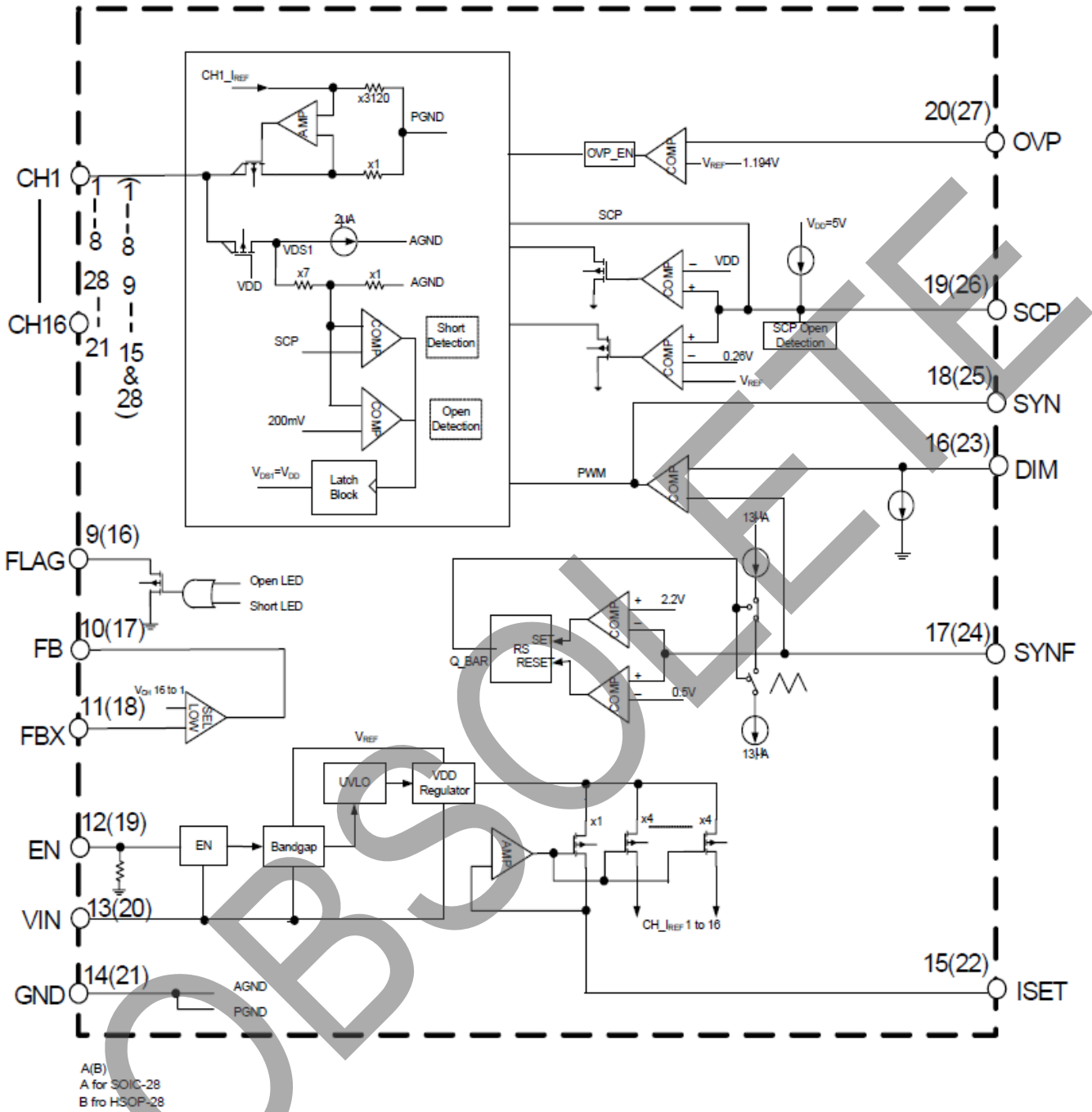
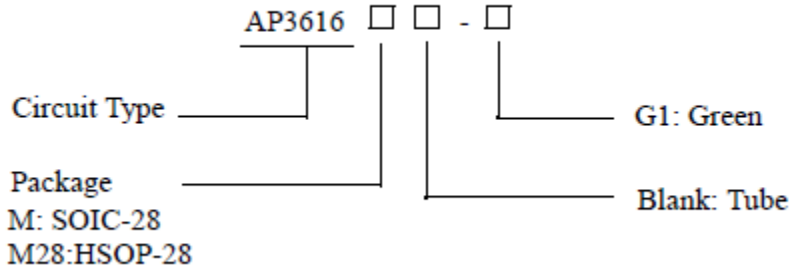

Figure 3. Functional Block Diagram of AP3616

Ordering Information



Part Number	Marking ID	Temperature Range	Package	Packing Type
AP3616M-G1	AP3616M-G1	-40 to 85°C	SOIC-28	Tube
AP3616M28-G1	AP3616M28-G1		HSOP-28	Tube

Absolute Maximum Ratings (@T_A = +25°C, unless otherwise specified.) (Note 4)

Parameter	Rating	Value	Unit
Input Voltage	V _{IN}	30	V
FLAG Pin Voltage	V _{FLAG}	30	V
EN Pin Voltage	V _{EN}	30	V
Voltage on Each Channel	V _{CHX}	-0.3 to 60	V
Voltage on Other Separate Pins	-	-0.3 to 60	V
Thermal Resistance (Junction to Ambient, No Heat Sink)	SOIC-28	72	°C/W
	HSOP-28	59	
Operating Junction Temperature	T _J	150	°C
Lead Temperature (Soldering, 10 sec)	T _{STG}	-65 to 150	°C
ESD (Human Body Model)	-	2,000	V
ESD (Machine Model)	-	200	V

Note 4: Stresses greater than those listed under "Absolute Maximum Ratings" may cause permanent damage to the device. These are stress ratings only, and functional operation of the device at these or any other conditions beyond those indicated under "Recommended Operating Conditions" is not implied. Exposure to "Absolute Maximum Ratings" for extended periods may affect device reliability.

OBSOLETE - PART DISCONTINUED

Recommended Operating Conditions (@T_A = +25°C, unless otherwise specified.)

Symbol	Parameter	Min	Max	Unit	
V _{CC}	Input Voltage	4.2	27	V	
f _{PWM}	Recommended PWM Dimming Frequency	0.08	25	kHz	
I _{CHX}	Full Scale Setting Current per Channel	V _{CHX} =0.5V	20	40	mA
		V _{CHX} =0.8V	20	60	
		V _{CHX} =1.2V	20	75	
T _A	Operating Temperature Range	-40	85	°C	

Electrical Characteristics (@T_A = +25°C, unless otherwise specified.)

Parameter	Symbol	Conditions	Min	Typ	Max	Unit
V_{CC} SECTION						
Quiescent Current	I _Q	ISET, SYN and FB Pin Floating	-	2	4	mA
Shutdown Supply Current	I _{STBY}	V _{EN} =0V, ISET, SYN and FB Pin Floating	-	0.1	1	μA
Undervoltage Lockout Threshold	V _{UVLO}	V _{IN} Falling Edge	3.65	3.9	4.15	V
Undervoltage Lockout Hysteresis	V _{UVLO_HYS}	-	-	300	-	mV
CHANNEL SECTION						
Maximum Output Current per Channel	I _{CHX_MAX}	V _{CHX} =0.8V, R _{ISET} =0	75	-	-	mA
Current Sink Saturation Voltage per Channel	V _{CHX_SAT}	I _{CHX} =60mA	-	-	0.6	V
Current Matching Accuracy between Any Two Channels	CH_MATCHING	I _{CHX} =60mA, V _{CH} =0.8V	-	-	3	%
Output Current Load Regulation	-	V _{CHX} =0.5V to 2.8V	-	-	4	%
Output Current Line Regulation (Note 5)	-	V _{CHX} =4.2V to 2.8V	-	-	2	%V

Note 5: Guaranteed by design (GBD).

Electrical Characteristics (Cont.) (@T_A = +25°C, unless otherwise specified.)

Parameter	Symbol	Conditions	Min	Typ	Max	Unit
DIMMING SECTION						
PWM High Level Threshold Voltage	V _{IH_PWM}	-	2.5	-	-	V
PWM Low Level Threshold Voltage	V _{IL_PWM}	-	-	-	0.3	V
Linear Dimming Level	V _{L_DIM}	-	0.5	-	2.2	V
LED SHORT PROTECTION SECTION						
SCP Current	I _{SCP}	-	10.5	12.5	14.5	μA
CURRENT SINK SECTION						
ISET Reference Voltage	V _{ISET}	R _{ISET} =30k, CH1 to CH16 Floating T _A = -40°C to +85°C	1.170	1.194	1.218	V
I _{CHX} /I _{SET} Current Multiplication Ratio	k	R _{ISET} =30k, V _{CHX} =1V	-	1615	-	-
ENABLE SECTION						
EN Pin High Level Threshold	V _{IH_EN}	-	2.0	-	-	V
EN Pin Low Level Threshold	V _{IL_EN}	-	-	-	0.8	V
OVP SECTION						
Threshold Voltage	V _{THRESHOLD}	-	1.130	1.194	1.250	V
FLAG SECTION						
Saturation Voltage	V _{SAT}	I _{SINK} =2mA	-	-	0.3	V
SYN SECTION						
PWM Frequency	f _{PWM}	-	0.08	-	25	kHz
SYNF High Level Output Voltage	V _{OUT_H}	-	2.4	-	-	V
SYNF Low Level Output Voltage	V _{OUT_L}	-	-	-	0.4	V
FB SECTION						
Feedback Output Current	I _{FB}	V _{FB} Drop to 97%	13	17	-	μA
TOTAL DEVICE						
Thermal Shutdown Temperature	T _{OTSD}	CHX Pin Left Floating	-	160	-	°C
Thermal Shutdown Hysteresis	T _{HYS}	-	-	20	-	°C

OBSOLETE - PART DISCONTINUED

Typical Performance Characteristics ($V_{IN}=24V$, $V_{EN}=5V$, $R_{ISET}=30k\Omega$, $T_A=25^\circ C$, unless otherwise specified.)

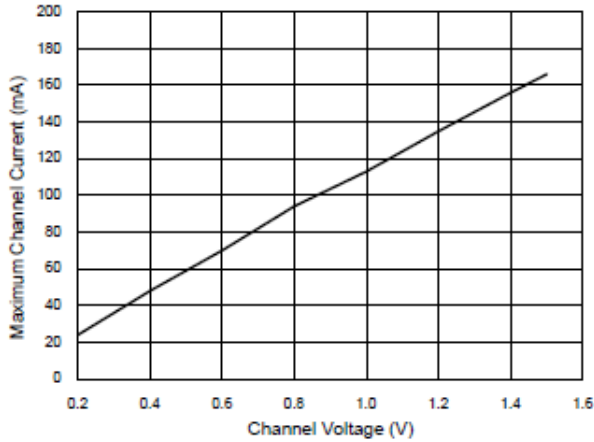

Figure 4. Maximum Channel Current vs. Channel Voltage

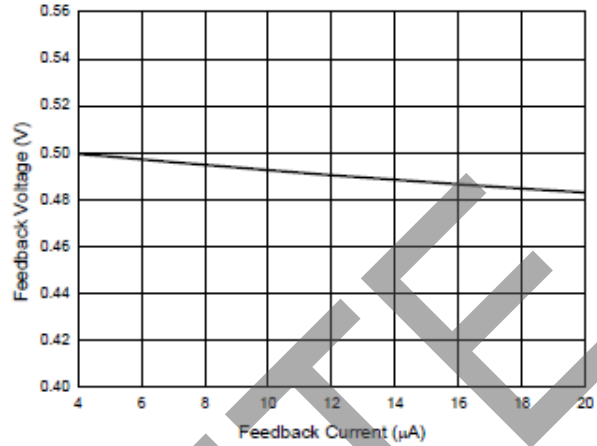

Figure 5. Feedback Voltage vs. Feedback Current

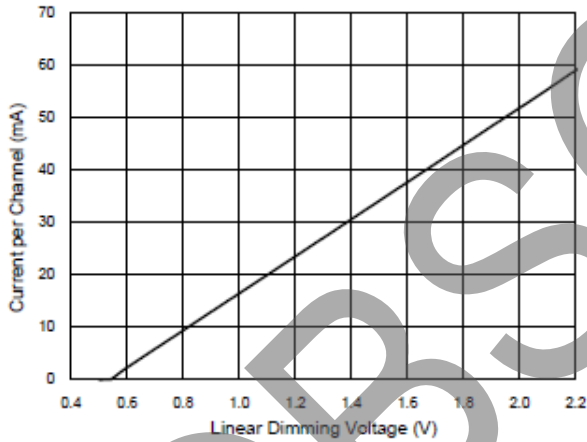

Figure 6. Channel Current vs. Linear Dimming Voltage

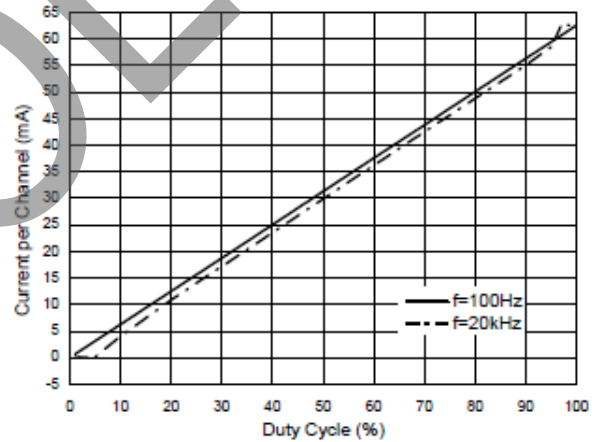

Figure 7. Current per Channel vs. Duty Cycle (PWM Dimming)

OBSOLETE - PART DISCONTINUED

Typical Performance Characteristics (Cont.) ($V_{IN}=24V$, $V_{EN}=5V$, $R_{ISET}=30k\Omega$, $T_A=25^\circ C$, unless otherwise specified.)

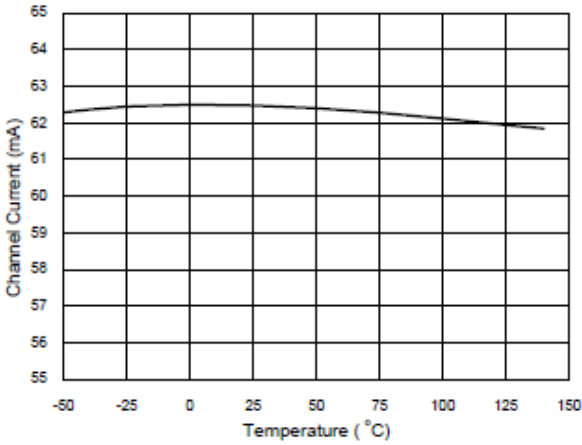

Figure 8. Channel Current vs. Temperature

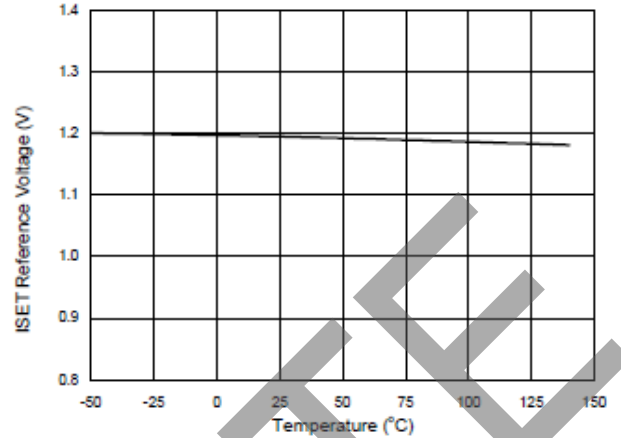

Figure 9. ISET Reference Voltage vs. Temperature

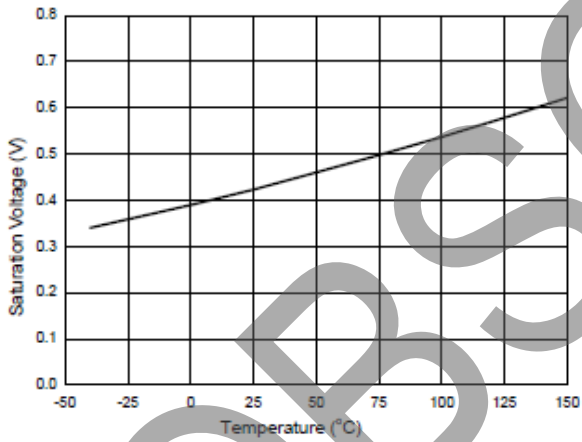

Figure 10. Saturation Voltage vs. Temperature

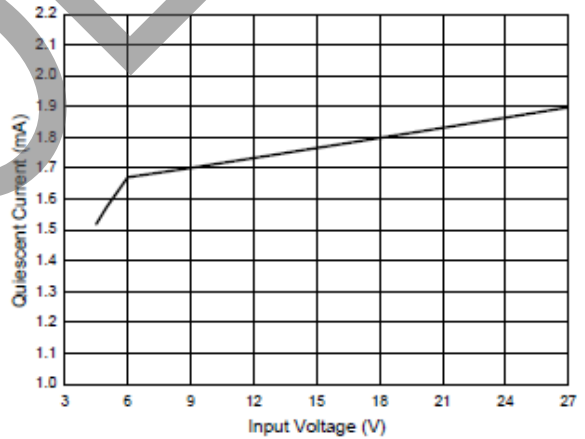

Figure 11. Quiescent Current vs. Input Voltage

OBSOLETE - PART DISCONTINUED

Typical Performance Characteristics (Cont.) ($V_{IN}=24V$, $V_{EN}=5V$, $R_{ISET}=30k\Omega$, $T_A=25^\circ C$, unless otherwise specified.)

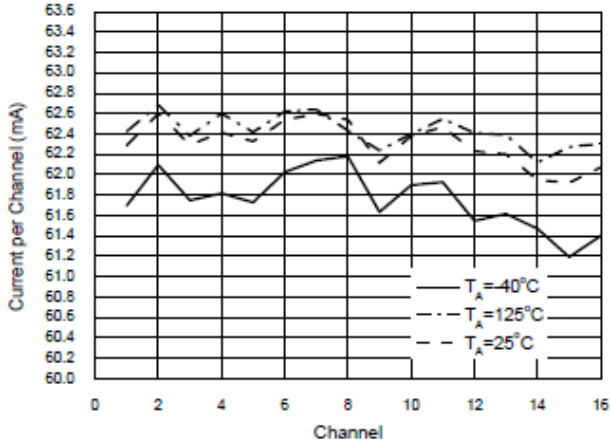

Figure 12. Current per Channel vs. Channel

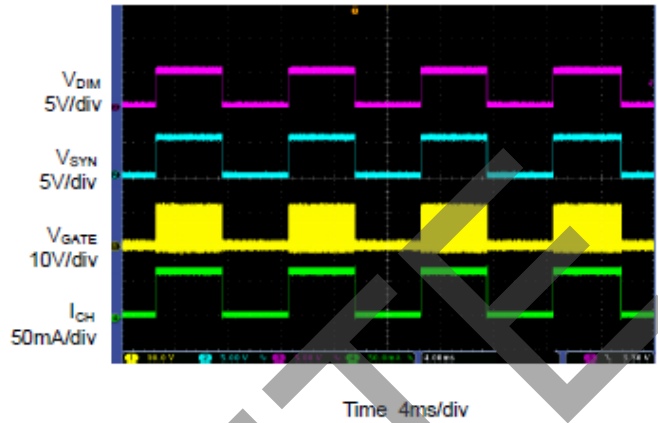

Figure 13. PWM Dimming ($f=100Hz$, Duty Cycle=50%)

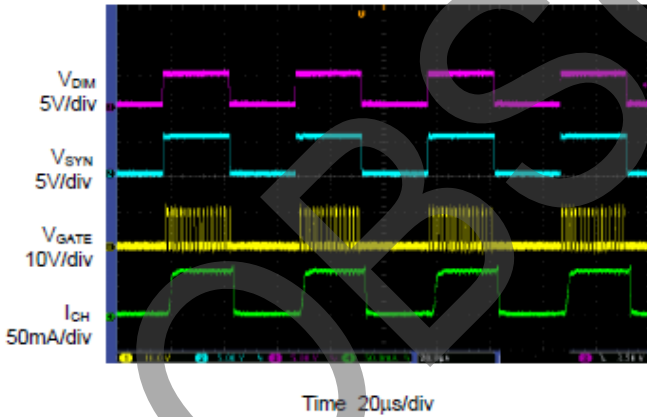

Figure 14. PWM Dimming ($f=20kHz$, Duty Cycle=50%)

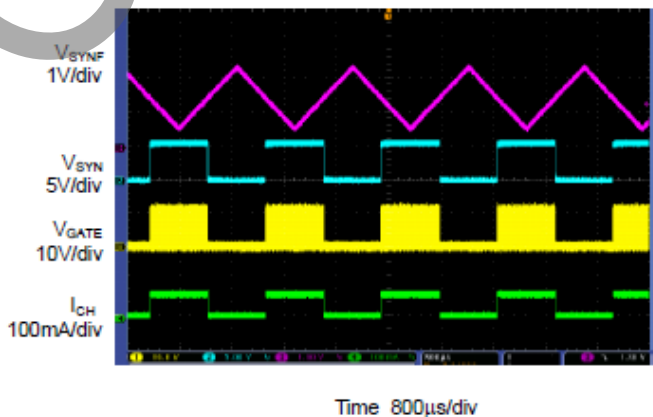
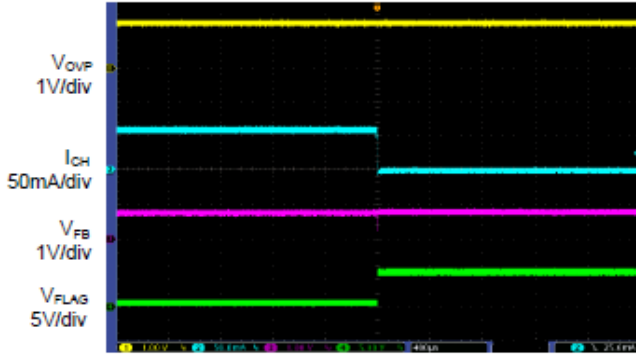

Figure 15. Linear Dimming ($V_{DIM}=1.4V$)

Typical Performance Characteristics (Cont.) ($V_{IN}=24V$, $V_{EN}=5V$, $R_{ISET}=30k\Omega$, $T_A=25^\circ C$, unless otherwise specified.)

OBSOLETE - PART DISCONTINUED



Time 400µs/div

Figure 16. LED Open Protection

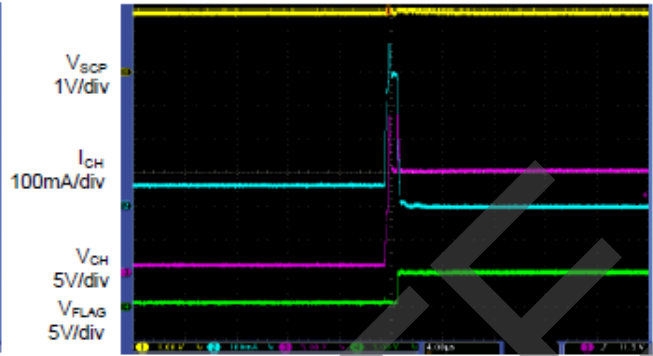

Time 4µs/div

Figure 17. LED Short Protection

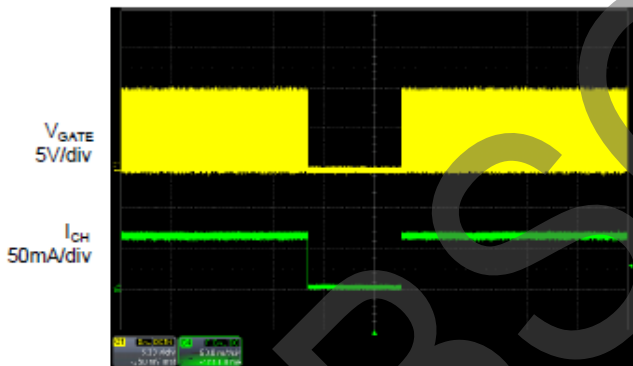

Time 2s/div

Figure 18. OTP and Recovery

Function Description

1. LED Current Setting

The maximum LED current per channel can be adjusted up to 75mA via ISET pin. When $\geq 75\text{mA}$ current is needed in application, two or more channels can be paralleled to provide larger drive current. Connect a resistor R_{ISET} between ISET pin and GND to set the reference current ISET. The LED current is determined by the following equation.

$$I_{LED} (mA) = \frac{k \cdot V_{ISET}}{R_{ISET} (k\Omega)} = \frac{1560 \times 1.194}{R_{ISET} (k\Omega)}$$

2. Dimming Control

The AP3616 provides two dimming methods: external PWM signal or DC voltage input. Applying a PWM signal to DIM pin to adjust the LED current, that means, the LED current of all enabled channels can be adjusted at the same time and the LED brightness can be adjusted from 1%*I_{CHX_MAX} to 100%*I_{CHX_MAX}. During the high level period of PWM signal, the LED is turned on and 100% of the current flows through LED, while during the low level period of the PWM signal, the LED is turned off and almost no current flows through the LED, thus changing the average current through LED and finally adjusting LED brightness. The external PWM signal frequency applied to PWM pin is allowed to be 80Hz or higher.

3. Overvoltage Protection

The AP3616 integrates an OVP circuit. The OVP pin is connected to the center tap of voltage-divider (ROV3 and ROV4) that placed between high voltage output and GND (Figure 19). If the voltage on OVP pin exceeds 1.194V, which may results from open loop or excessive output voltage, the AP3616 will start LED open protection.

$$V_{OVP} = \frac{(R_{OV3} + R_{OV4}) \times 1.194V}{R_{OV4}}$$

4. LED Short-Circuit Protection

The AP3616 integrates an LED short-circuit protection circuit. During normal operation, any shortcircuited LED will cause the corresponding LED pin voltage to rise. If any LED pin voltage exceeds 8 times of the voltage at SCP pin, the corresponding LED current sink will be latched off, while the remaining string(s) keep normal operation. Toggle the VIN and/or EN to reset the latch. An internal current source was connected to this pin, a resistor connected here is used to set the shorting LED trigger voltage.

5. LED Open-Circuit Protection

The AP3616 integrates an LED Open-Circuit Protection circuit. When any LED string is open, V_{OUT} will boost up until the voltage at OVP pin reaches an approximate 1.194V threshold. The IC will automatically ignore the open string(s) whose CHX pin voltage is less than 100mV.

OBSOLETE

Typical Application

OBSOLETE - PART DISCONTINUED

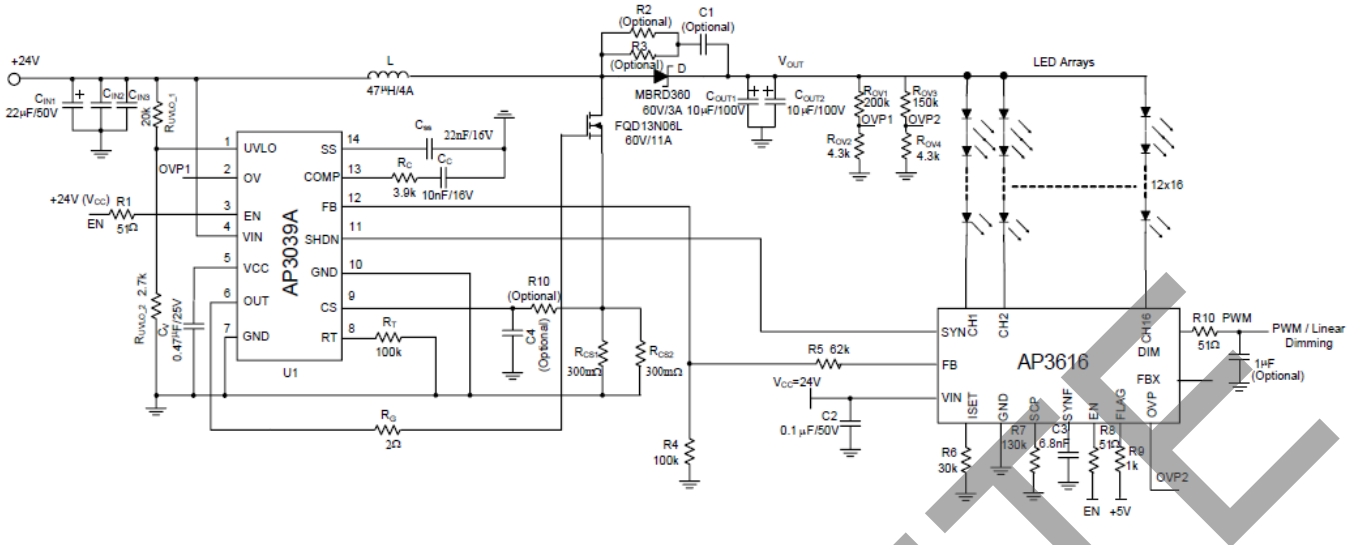

Single Chip Application (12S16P)

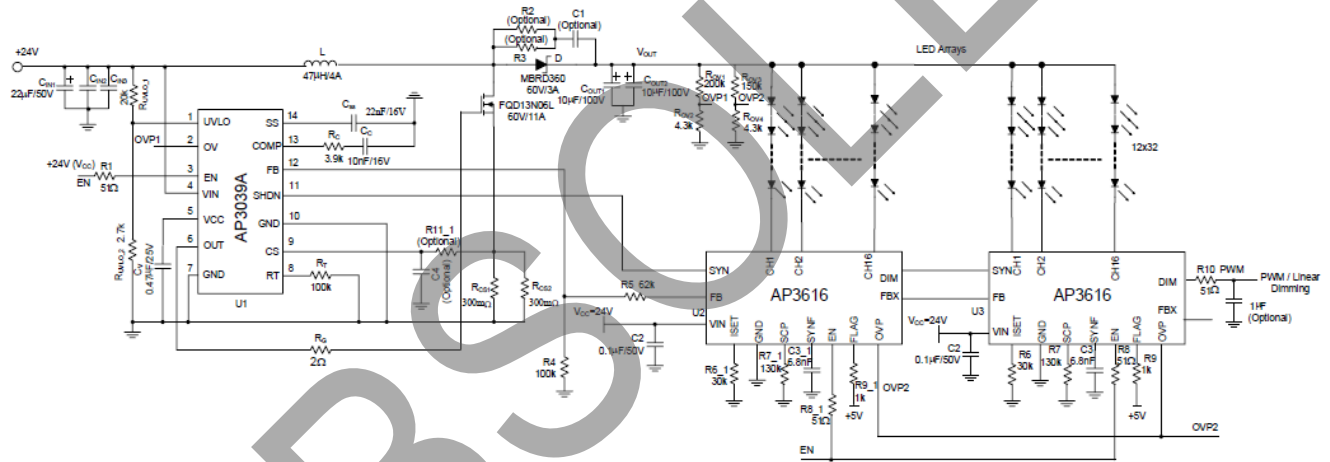

Multi Chips Application (12S32P)

Figure 19. Typical Applications of AP3616

Mechanical Dimensions

SOIC-28 Unit: mm(inch)

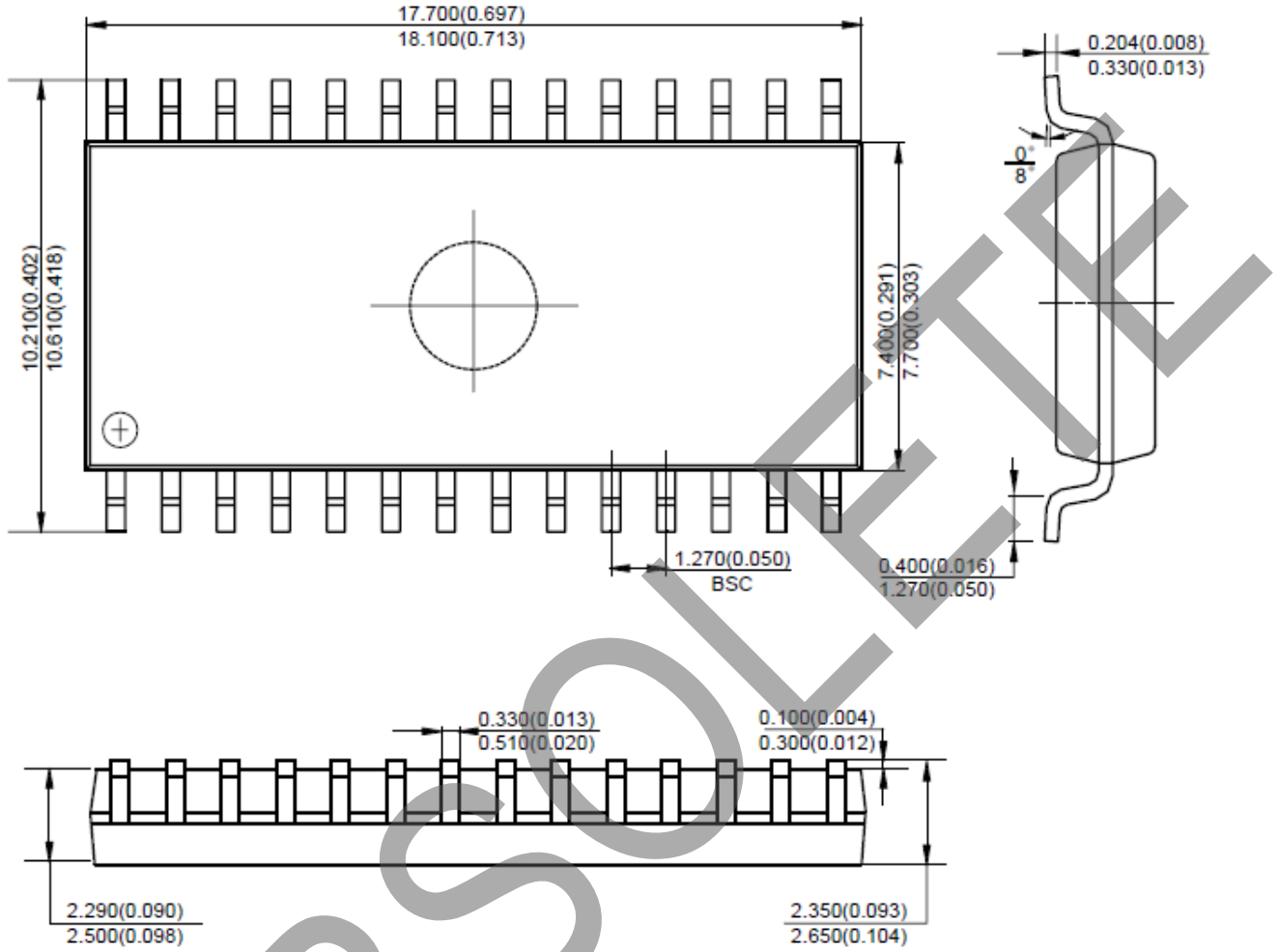

Note: Eject hole, oriented hole and mold mark is optional.

OBSOLETE - PART DISCONTINUED

OBSOLETE

Mechanical Dimensions (Cont.)

HSOP-28 Unit: mm(inch)

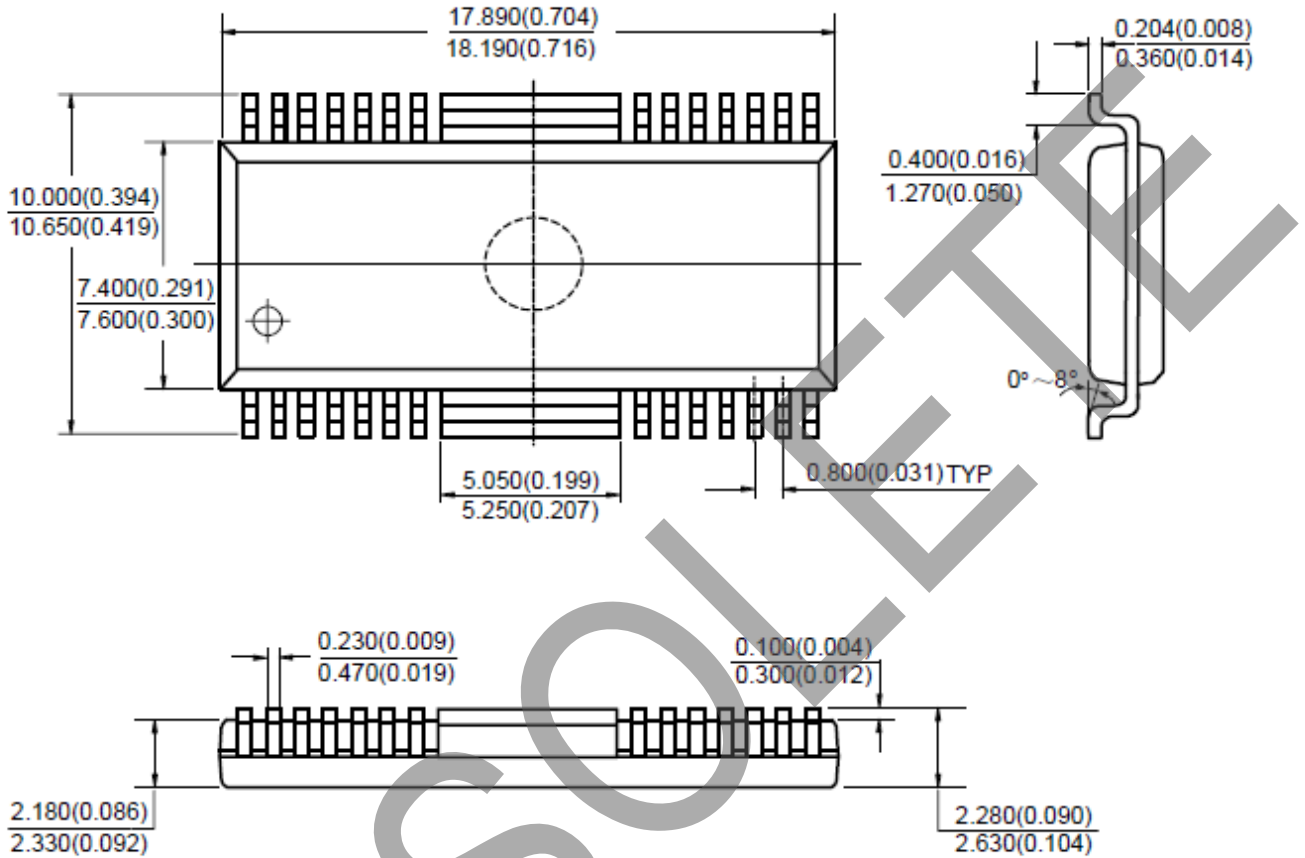

Note: Eject hole, oriented hole and mold mark is optional.

OBSOLETE - PART DISCONTINUED

OBSOLETE

Suggested Pad Layout

(1) SOIC-28

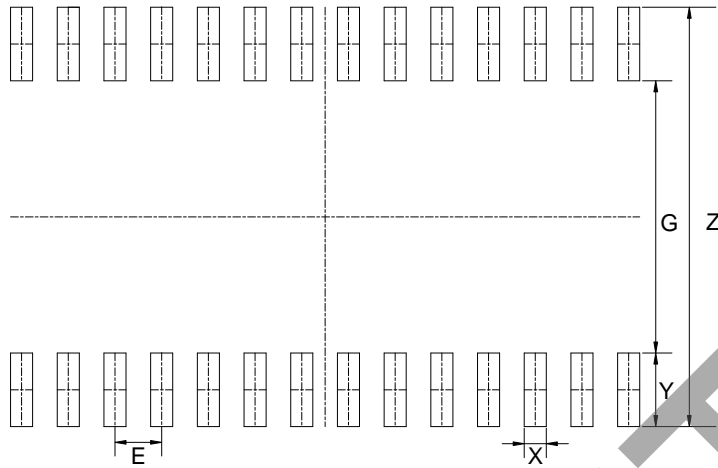

Dimensions	Z (mm)/(inch)	G (mm)/(inch)	X (mm)/(inch)	Y (mm)/(inch)	E (mm)/(inch)
Value	11.400/0.449	7.400/0.291	0.600/0.024	2.000/0.079	1.270/0.050

ALL DIMENSIONS ARE NOMINAL VALUES SHOWN IN MILLIMETERS

Note: The suggested land pattern dimensions have been provided for reference only, as actual pad layouts may vary depending on application. These numbers may be modified based on user equipment capability or fabrication criteria. A more robust pattern may be desired for wave soldering and is calculated by adding 0.2 mm to the 'Z' dimension. For further information, please reference document IPC-7351A, Naming Convention for Standard SMT Land Patterns, and for International grid details, please see document IEC, Publication 97.

OBSOLETE - PART DISCONTINUED

OBSOLETE

Suggested Pad Layout (Cont.)

(2) HSOP-28

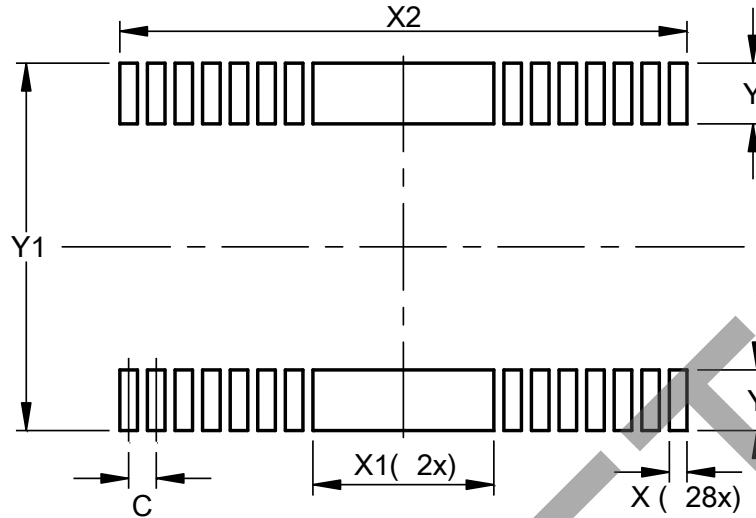

Dimensions	Value (in mm)
C	0.80
X	0.51
X1	5.25
X2	16.45
Y	1.75
Y1	10.60

ALL DIMENSIONS ARE NOMINAL VALUES SHOWN IN MILLIMETERS

Note: The suggested land pattern dimensions have been provided for reference only, as actual pad layouts may vary depending on application. These numbers may be modified based on user equipment capability or fabrication criteria. A more robust pattern may be desired for wave soldering and is calculated by adding 0.2 mm to the 'Z' dimension. For further information, please reference document IPC-7351A, Naming Convention for Standard SMT Land Patterns, and for International grid details, please see document IEC, Publication 97.

OBSOLETE - PART DISCONTINUED

OBSOLETE

IMPORTANT NOTICE

DIODES INCORPORATED MAKES NO WARRANTY OF ANY KIND, EXPRESS OR IMPLIED, WITH REGARDS TO THIS DOCUMENT, INCLUDING, BUT NOT LIMITED TO, THE IMPLIED WARRANTIES OF MERCHANTABILITY AND FITNESS FOR A PARTICULAR PURPOSE (AND THEIR EQUIVALENTS UNDER THE LAWS OF ANY JURISDICTION).

Diodes Incorporated and its subsidiaries reserve the right to make modifications, enhancements, improvements, corrections or other changes without further notice to this document and any product described herein. Diodes Incorporated does not assume any liability arising out of the application or use of this document or any product described herein; neither does Diodes Incorporated convey any license under its patent or trademark rights, nor the rights of others. Any Customer or user of this document or products described herein in such applications shall assume all risks of such use and will agree to hold Diodes Incorporated and all the companies whose products are represented on Diodes Incorporated website, harmless against all damages.

Diodes Incorporated does not warrant or accept any liability whatsoever in respect of any products purchased through unauthorized sales channel. Should Customers purchase or use Diodes Incorporated products for any unintended or unauthorized application, Customers shall indemnify and hold Diodes Incorporated and its representatives harmless against all claims, damages, expenses, and attorney fees arising out of, directly or indirectly, any claim of personal injury or death associated with such unintended or unauthorized application.

Products described herein may be covered by one or more United States, international or foreign patents pending. Product names and markings noted herein may also be covered by one or more United States, international or foreign trademarks.

This document is written in English but may be translated into multiple languages for reference. Only the English version of this document is the final and determinative format released by Diodes Incorporated.

LIFE SUPPORT

Diodes Incorporated products are specifically not authorized for use as critical components in life support devices or systems without the express written approval of the Chief Executive Officer of Diodes Incorporated. As used herein:

- A. Life support devices or systems are devices or systems which:
1. are intended to implant into the body, or
 2. support or sustain life and whose failure to perform when properly used in accordance with instructions for use provided in the labeling can be reasonably expected to result in significant injury to the user.
- B. A critical component is any component in a life support device or system whose failure to perform can be reasonably expected to cause the failure of the life support device or to affect its safety or effectiveness.

Customers represent that they have all necessary expertise in the safety and regulatory ramifications of their life support devices or systems, and acknowledge and agree that they are solely responsible for all legal, regulatory and safety-related requirements concerning their products and any use of Diodes Incorporated products in such safety-critical, life support devices or systems, notwithstanding any devices- or systems-related information or support that may be provided by Diodes Incorporated. Further, Customers must fully indemnify Diodes Incorporated and its representatives against any damages arising out of the use of Diodes Incorporated products in such safety-critical, life support devices or systems.

Copyright © 2019, Diodes Incorporated

www.diodes.com

OBSOLETE