

## Description

The AP9060 is designed to protect the latest generation of PMICs for portable applications such as Smartphones, UMPCs and others that utilize battery power.

The device, with its integrated low resistance p-channel MOSFET, operates as a switch and passes the input voltage through to the output till the input reaches a clamp voltage limit. Once  $V_{IN}$  goes above the clamp limit, which is set to 11.15V, the output voltage gets clamped and the feedback loop maintains the clamped  $V_{OUT}$  by reducing the drive to the p-channel FET.

The output voltage is clamped at 11.15V to ensure that a following PMIC can detect a faulty charger and ensure safe and proper communication to the system.

The AP9060 also supports reverse operation whereby it can pass up to 1A of current from the PMIC to the load connected to the USB port. This makes the AP9060 suitable for USB On-The-Go enabled devices.

The AP9060 protection device is available in a low-profile W-DFN1114-3 package with a typical height of 0.8mm.

## Applications

- Power interface for new generation PMICs
- Charger front-end protections
- Smartphones
- UMPC
- Portable applications

## Pin Assignments

**W-DFN1114-3**

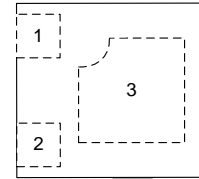

Top View



## Features

- Wide Input Voltage Range of 3V to 30V
- Ultra-Low Bias Current
- Integrated Low On-Resistance P-Channel FET
- Output Voltage Clamped at 11.15V
- PMOS Protection Mechanism – Removes EMI Issues Typically Associated with an NMOS Solution
- Supports Reverse Current Operation (USB OTG)
- Available in a W-DFN1114-3 Package
- **Totally Lead-Free & Fully RoHS Compliant (Notes 1 & 2)**
- **Halogen and Antimony Free. “Green” Device (Note 3)**
- **For automotive applications requiring specific change control (i.e. parts qualified to AEC-Q100/101/104/200, PPAP capable, and manufactured in IATF 16949 certified facilities), please [contact us](#) or your local Diodes representative. <https://www.diodes.com/quality/product-definitions/>**

Notes: 1. No purposely added lead. Fully EU Directive 2002/95/EC (RoHS) & 2011/65/EU (RoHS 2) compliant.  
 2. See <http://www.diodes.com> for more information about Diodes Incorporated’s definitions of Halogen- and Antimony-free, “Green” and Lead-free.  
 3. Halogen- and Antimony-free “Green” products are defined as those which contain <900ppm bromine, <900ppm chlorine (<1500ppm total Br + Cl) and <1000ppm antimony compounds.

OBSOLETE - PART DISCONTINUED

**Typical Applications Circuit**

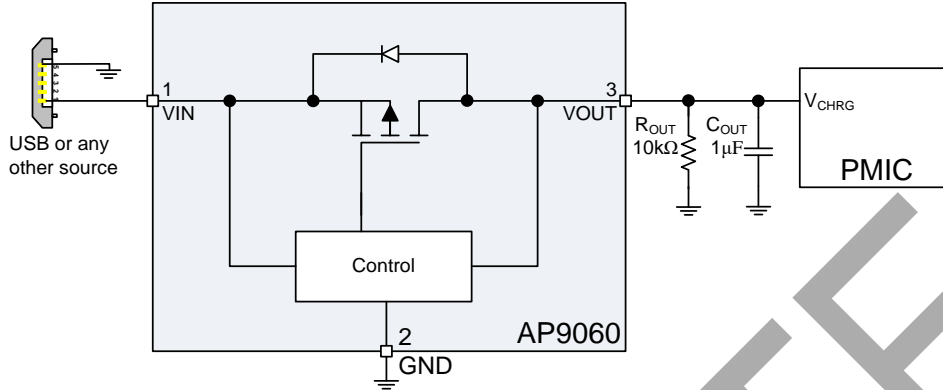

Figure 1 Typical Application Circuit

**Pin Descriptions**

Pin Number	Pin Name	Function
1	VIN	Input voltage to the device.
2	GND	System ground.
3/PAD	VOUT	Output voltage, which follows VIN and gets clamped if VIN exceeds the clamp voltage of 11.15V (typ).

**Functional Block Diagram**

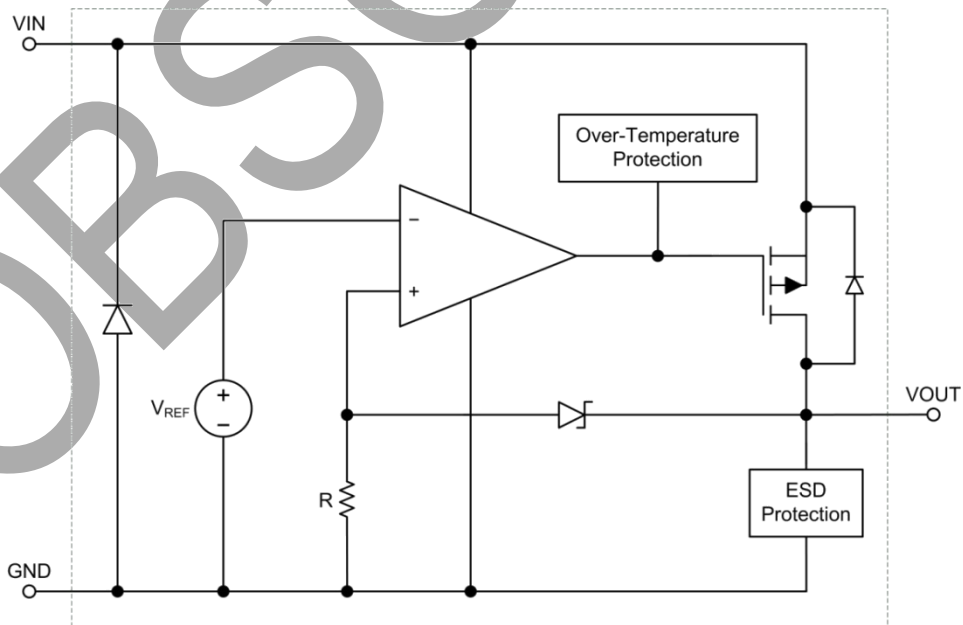

Figure 2 Functional Block Diagram

**Absolute Maximum Ratings** (Note 4) (@T<sub>A</sub> = +25°C, unless otherwise specified.)

Symbol	Parameter	Rating	Unit
V <sub>IN</sub>	Input Supply Voltage	-0.3 to +30	V
I <sub>MAX</sub>	Maximum Continuous Switch Current (Note 6) T <sub>A</sub> = +25°C T <sub>A</sub> = +85°C	2.6 1.6	A
P <sub>D</sub>	Power Dissipation @ T <sub>A</sub> = +25°C (Note 6)	1.1	W
T <sub>J</sub>	Junction Temperature Range	-40 to +125	°C
T <sub>STG</sub>	Storage Temperature Range	-55 to +150	°C
T <sub>L</sub>	Maximum Lead Temperature for Soldering Purposes	260	°C
<b>ESD Susceptibility (Note 5)</b>			
HBM	Human Body Model	8.0	kV
MM	Machine Model	350	V

- Notes:
- Stresses greater than those listed under “*Absolute Maximum Ratings*” can cause permanent damage to the device. These are stress ratings only, and functional operation of the device at these or any other conditions beyond those indicated under “*Recommended Operating Conditions*” is not implied. Exposure to “*Absolute Maximum Ratings*” for extended periods can affect device reliability.
  - Semiconductor devices are ESD sensitive and may be damaged by exposure to ESD events. Suitable ESD precautions should be taken when handling and transporting these devices.
  - Surface mounted on JEDEC’s High Effective Thermal Conductivity Test Board (JESD51-7).

**Thermal Resistance** (Note 6)

Symbol	Parameter	Rating	Unit
θ <sub>JA</sub>	Junction to Ambient	85	°C/W

- Note: 6. Surface mounted on JEDEC’s High Effective Thermal Conductivity Test Board (JESD51-7).

**Recommended Operating Conditions** (Note 7) (@T<sub>A</sub> = +25°C, unless otherwise specified.)

Symbol	Parameter	Min	Max	Unit
V <sub>IN</sub>	Supply Voltage	3	30	V
T <sub>A</sub>	Operating Ambient Temperature Range	-40	+85	°C

- Note: 7. The device function is not guaranteed outside of the recommended operating conditions.

**Electrical Characteristics** (@T<sub>A</sub> = +25°C, unless otherwise specified.)

AP9060 is tested at V<sub>IN</sub> = 5V, I<sub>OUT</sub> = 0mA, unless otherwise noted.

Symbol	Parameter	Test Conditions	Min	Typ	Max	Unit
V <sub>CLAMP</sub>	Output clamp voltage	V <sub>IN</sub> = 30V	10.8	11.15	11.5	V
R <sub>ON</sub>	On-Resistance (Note 8)	V <sub>IN</sub> = 5V, I <sub>OUT</sub> = 1000mA V <sub>IN</sub> = 3V, I <sub>OUT</sub> = 1000mA	—	90 105	120 139	mΩ
V <sub>pk</sub>	Peak Output Voltage (Note 9)	V <sub>IN</sub> goes from 0V to 30V with 100ns rise time, C <sub>OUT</sub> = 100nF	—	—	16.0	V
I <sub>bias</sub>	Input Bias Current	V <sub>IN</sub> = 5V V <sub>IN</sub> = 30V	—	5 25	6 31	μA
THM <sub>SD</sub>	Thermal Shutdown Threshold (Note 9)	R <sub>OUT</sub> = 10kΩ	—	140	—	°C
THM <sub>hyst</sub>	Thermal Shutdown Hysteresis (Note 9)	R <sub>OUT</sub> = 10kΩ	—	20	—	°C
V <sub>OUT_REV</sub>	Reverse Supply Voltage on V <sub>OUT</sub> (Note 10)	I <sub>IN</sub> = -500mA	3.0	5.0	8.0	V
I <sub>IN_REV</sub>	Reverse Load Current on V <sub>IN</sub> (Note 10)	V <sub>OUT</sub> = 5V	—	-500	-1000	mA
T <sub>start</sub>	Soft-Start Time	V <sub>IN</sub> = 5V	—	10	—	ms

- Notes:
- Pulse tested with a width of 20ms.
  - Guaranteed by design.
  - To support reverse power operation, as in the case of USB OTG systems. A voltage source is connected to V<sub>OUT</sub> and a load connected on V<sub>IN</sub>.

**Typical Performance Characteristics**

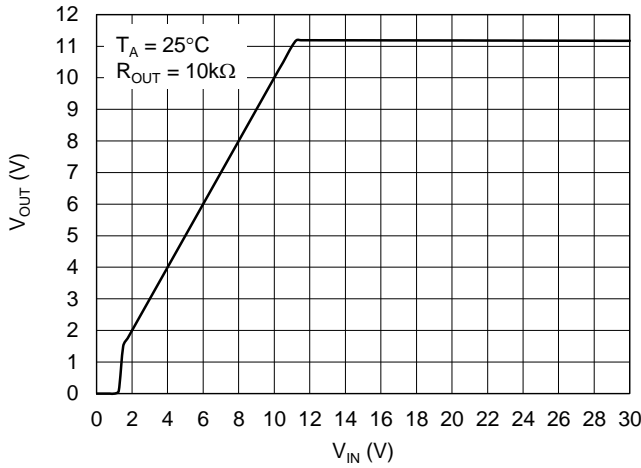

Figure 3 V<sub>OUT</sub> vs. V<sub>IN</sub>

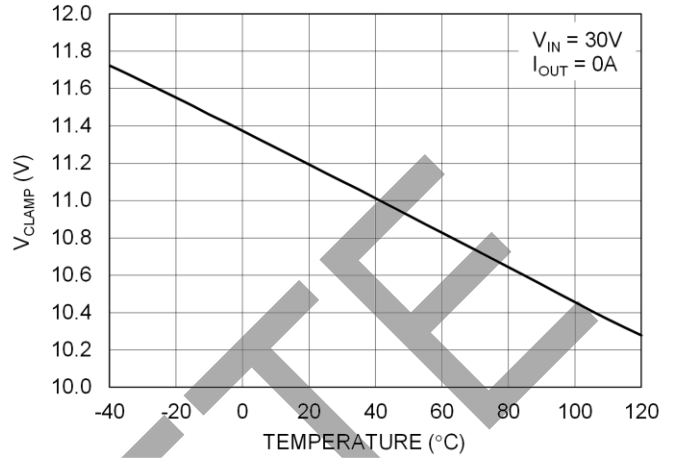

Figure 4 Output Clamp Voltage vs. Temperature

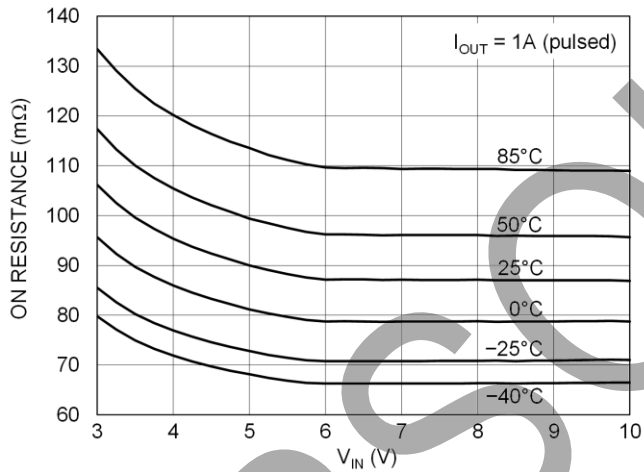

Figure 5 On-Resistance vs. V<sub>IN</sub> and Temperature

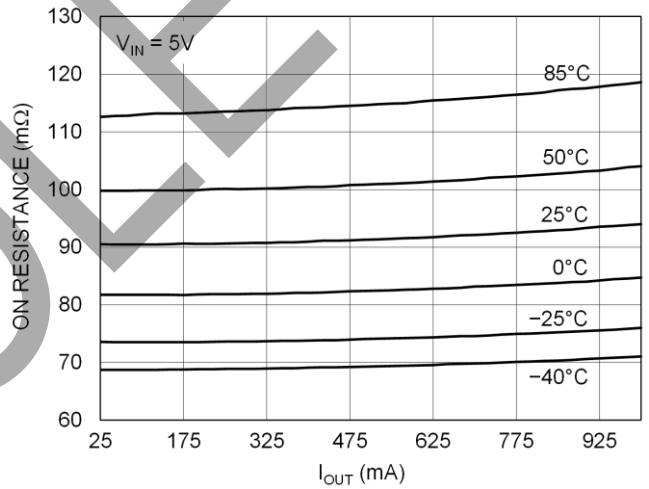

Figure 6 On-Resistance vs. I<sub>OUT</sub> and Temperature

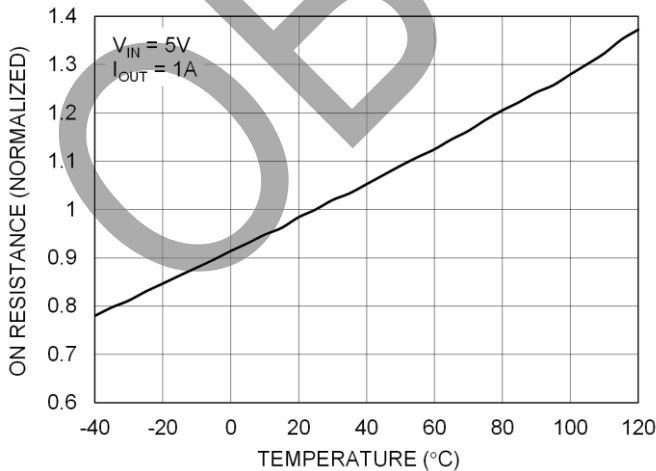

Figure 7 On-Resistance (Normalized) vs. Temperature

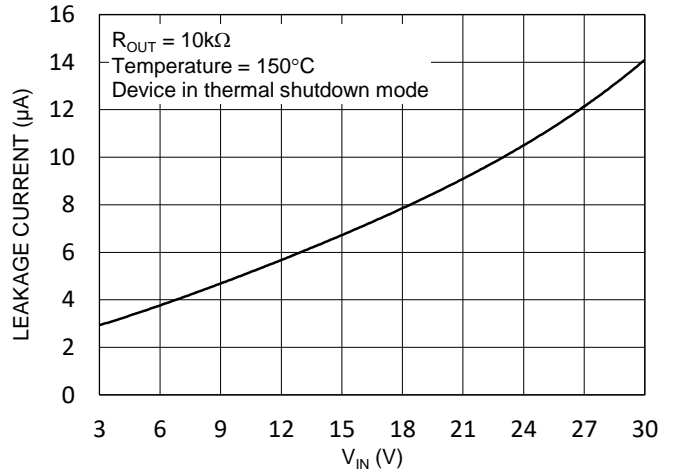

Figure 8 FET Leakage Current (in Thermal Shutdown) vs. V<sub>IN</sub>

---

## Application Information

---

### Over-Voltage Protection

The AP9060 protects sensitive circuits by clamping the input voltage to a safe level. In other words, the AP9060 conditions the input voltage before presenting it to the sensitive circuitry.

The clamp voltage on the AP9060 is set to 11.15V (typically at room temperature). Therefore, the sensitive circuitry will not be exposed to a voltage greater than 11.15V. As a consequence, it is important to ensure that the sensitive ICs that follow the AP9060 are safe to operate up to the clamp voltage level (refer to Figure 4 for variation in clamp voltage over temperature).

If the input voltage is below  $V_{CLAMP}$ , the PMOS pass transistor in the AP9060 fully turns on and only  $I \times R_{ON}$  is dropped across the FET (where,  $I$  is the current drawn by the sensitive ICs). On the other hand, if  $V_{IN}$  is greater than the clamp voltage, then the AP9060 limits the drive to the FET to ensure that the voltage on  $V_{OUT}$  is maintained at the clamp level.

### Over-Temperature Protection

As a secondary protection mechanism, the AP9060 incorporates an over-temperature shutdown feature. Therefore, if the sensitive circuitry draws too much current either in normal mode or in the clamp mode, the AP9060 will turn off the PMOS transistor, provided the junction temperature exceeds the thermal shutdown threshold ( $THM_{SD}$ ). Thereafter, the device will resume normal operation once the junction temperature falls below  $THM_{SD} - THM_{hyst}$ .

In the clamp mode, given that any input voltage above  $V_{CLAMP}$  is dropped across the pass transistor in the AP9060, care must be taken to keep the power dissipation within the AP9060 in check by minimising the current drawn in this mode.

### Fast Input Transient Protection

The AP9060 will also protect the sensitive circuits against fast input transients. Upon detecting a fast transient on  $V_{IN}$ , the AP9060 reduces the drive to the FET in order to minimise the overshoot on  $V_{OUT}$ . With 100nF on  $V_{OUT}$ , if the voltage on  $V_{IN}$  goes from 0V to 30V in 100ns, the output voltage will not peak above  $V_{pk}$ .

### Reverse Operation

The AP9060 supports the USB OTG specification and can operate in the reverse direction as well. Therefore, if the sensitive circuitry drives a voltage on  $V_{OUT}$  ( $V_{OUT\_REV}$ ) and a load is connected on  $V_{IN}$  ( $I_{IN\_REV}$ ), then the AP9060 will turn the FET on in the reverse direction and only  $I \times R_{ON}$  will be dropped across the device, similar to the forward operation.

However, note that neither over-voltage nor over-temperature protection mechanisms will function in this mode.

### Output Capacitor

It is recommended to have a capacitor on  $V_{OUT}$  in a range between 100nF and 10 $\mu$ F.

### Output Resistor

It is recommended to have a resistor on  $V_{OUT}$  in a range between 10k $\Omega$  and 100k $\Omega$ .

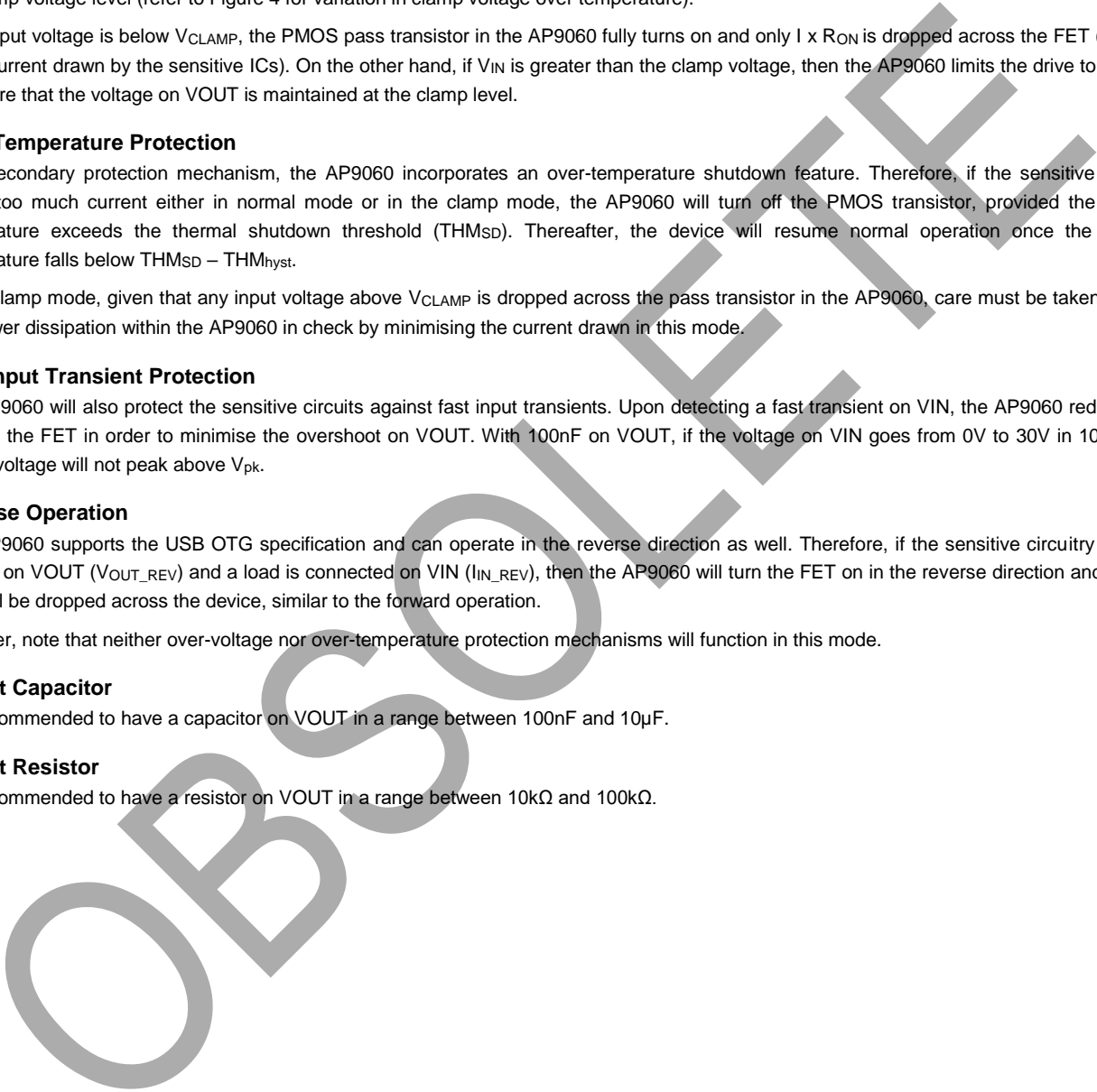

OBSOLETE - PART DISCONTINUED

**Ordering Information**

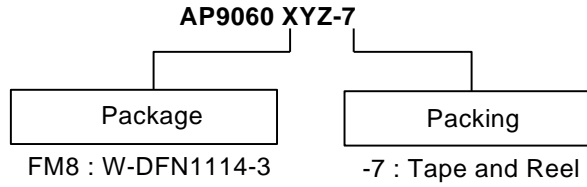

Part Number	Package Code	Package (Note 11)	Packing	
			Qty.	Carrier
AP9060FM8-7	FM8	W-DFN1114-3	3000	7" Tape & Reel

Note: 11. For packaging details, go to our website at <https://www.diodes.com/design/support/packaging/diodes-packaging/>.

**Marking Information**

W-DFN1114-3

( Top View )

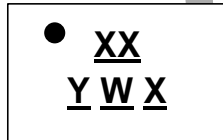

- XX : Identification Code
- Y : Year 0 to 9
- W : Week : A to Z : 1 to 26 Week;  
a to z : 27 to 52 Week; z Represents  
52 and 53 Week
- X : A to Z : Internal Code

Device	Package	Identification Code
AP9060FM8-7	W-DFN1114-3	CZ

**Package Outline Dimensions**

Please see <http://www.diodes.com/package-outlines.html> for the latest version.

W-DFN1114-3

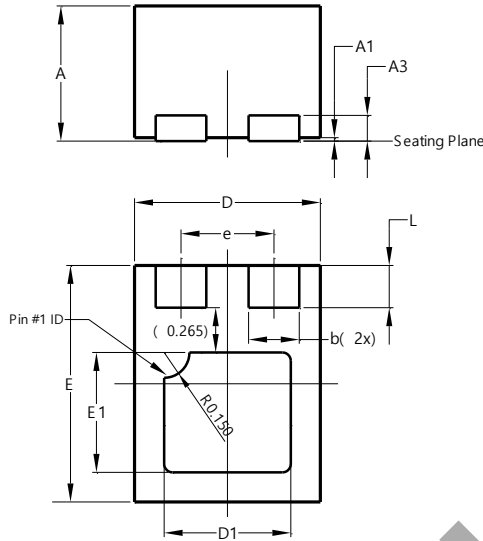

W-DFN1114-3			
Dim	Min	Max	Typ
A	0.77	0.83	0.80
A1	0	0.05	0.02
A3	-	-	0.152
b	0.25	0.35	0.30
D	1.05	1.15	1.10
D1	0.70	0.80	0.75
e	-	-	0.55
E	1.35	1.45	1.40
E1	0.66	0.76	0.71
L	0.20	0.30	0.25
All Dimensions in mm			

**Suggested Pad Layout**

Please see <http://www.diodes.com/package-outlines.html> for the latest version.

W-DFN1114-3

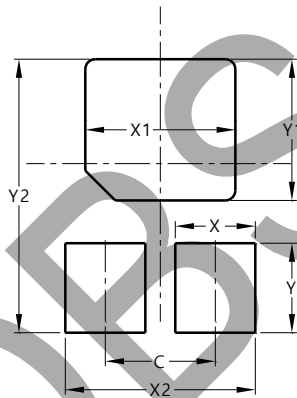

Dimensions	Value(in mm)
C	0.550
X	0.400
X1	0.750
X2	0.950
Y	0.450
Y1	0.710
Y2	1.375

OBSOLETE - PART DISCONTINUED

**Tape Orientation** (All Dimensions in mm.) (Note 12)

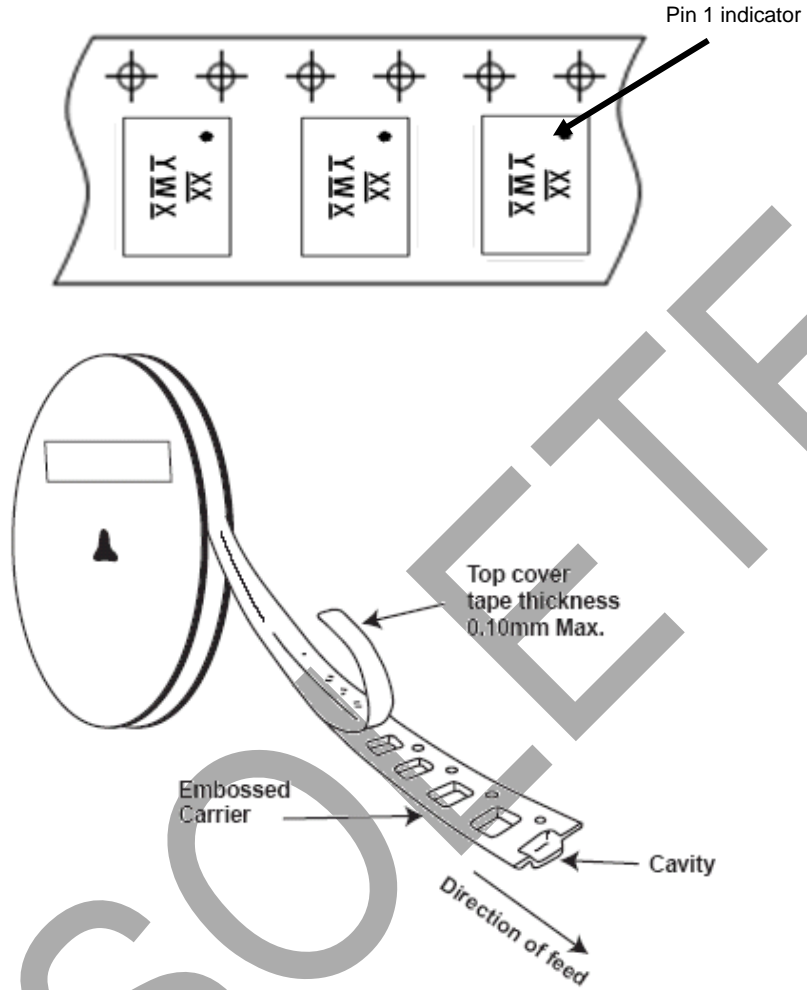

Note: 12. The taping orientation of the other package type can be found on our website at <http://www.diodes.com/package-outlines.html>.

OBSOLETE - PART DISCONTINUED

OBSOLETE



**IMPORTANT NOTICE**

1. DIODES INCORPORATED (Diodes) AND ITS SUBSIDIARIES MAKE NO WARRANTY OF ANY KIND, EXPRESS OR IMPLIED, WITH REGARDS TO ANY INFORMATION CONTAINED IN THIS DOCUMENT, INCLUDING, BUT NOT LIMITED TO, THE IMPLIED WARRANTIES OF MERCHANTABILITY, FITNESS FOR A PARTICULAR PURPOSE OR NON-INFRINGEMENT OF THIRD PARTY INTELLECTUAL PROPERTY RIGHTS (AND THEIR EQUIVALENTS UNDER THE LAWS OF ANY JURISDICTION).
2. The Information contained herein is for informational purpose only and is provided only to illustrate the operation of Diodes' products described herein and application examples. Diodes does not assume any liability arising out of the application or use of this document or any product described herein. This document is intended for skilled and technically trained engineering customers and users who design with Diodes' products. Diodes' products may be used to facilitate safety-related applications; however, in all instances customers and users are responsible for (a) selecting the appropriate Diodes products for their applications, (b) evaluating the suitability of Diodes' products for their intended applications, (c) ensuring their applications, which incorporate Diodes' products, comply the applicable legal and regulatory requirements as well as safety and functional-safety related standards, and (d) ensuring they design with appropriate safeguards (including testing, validation, quality control techniques, redundancy, malfunction prevention, and appropriate treatment for aging degradation) to minimize the risks associated with their applications.
3. Diodes assumes no liability for any application-related information, support, assistance or feedback that may be provided by Diodes from time to time. Any customer or user of this document or products described herein will assume all risks and liabilities associated with such use, and will hold Diodes and all companies whose products are represented herein or on Diodes' websites, harmless against all damages and liabilities.
4. Products described herein may be covered by one or more United States, international or foreign patents and pending patent applications. Product names and markings noted herein may also be covered by one or more United States, international or foreign trademarks and trademark applications. Diodes does not convey any license under any of its intellectual property rights or the rights of any third parties (including third parties whose products and services may be described in this document or on Diodes' website) under this document.
5. Diodes' products are provided subject to Diodes' Standard Terms and Conditions of Sale (<https://www.diodes.com/about/company/terms-and-conditions/terms-and-conditions-of-sales/>) or other applicable terms. This document does not alter or expand the applicable warranties provided by Diodes. Diodes does not warrant or accept any liability whatsoever in respect of any products purchased through unauthorized sales channel.
6. Diodes' products and technology may not be used for or incorporated into any products or systems whose manufacture, use or sale is prohibited under any applicable laws and regulations. Should customers or users use Diodes' products in contravention of any applicable laws or regulations, or for any unintended or unauthorized application, customers and users will (a) be solely responsible for any damages, losses or penalties arising in connection therewith or as a result thereof, and (b) indemnify and hold Diodes and its representatives and agents harmless against any and all claims, damages, expenses, and attorney fees arising out of, directly or indirectly, any claim relating to any noncompliance with the applicable laws and regulations, as well as any unintended or unauthorized application.
7. While efforts have been made to ensure the information contained in this document is accurate, complete and current, it may contain technical inaccuracies, omissions and typographical errors. Diodes does not warrant that information contained in this document is error-free and Diodes is under no obligation to update or otherwise correct this information. Notwithstanding the foregoing, Diodes reserves the right to make modifications, enhancements, improvements, corrections or other changes without further notice to this document and any product described herein. This document is written in English but may be translated into multiple languages for reference. Only the English version of this document is the final and determinative format released by Diodes.
8. Any unauthorized copying, modification, distribution, transmission, display or other use of this document (or any portion hereof) is prohibited. Diodes assumes no responsibility for any losses incurred by the customers or users or any third parties arising from any such unauthorized use.
9. This Notice may be periodically updated with the most recent version available at <https://www.diodes.com/about/company/terms-and-conditions/important-notice>

The Diodes logo is a registered trademark of Diodes Incorporated in the United States and other countries.  
All other trademarks are the property of their respective owners.  
© 2023 Diodes Incorporated. All Rights Reserved.

[www.diodes.com](http://www.diodes.com)