

Description

The APX4558 device is a dual low noise operational amplifier. The wide bandwidth and low noise make it very suited to audio applications.

The device is short-circuit protected, and the internal frequency compensation ensures stability without external components.

Pin Assignments

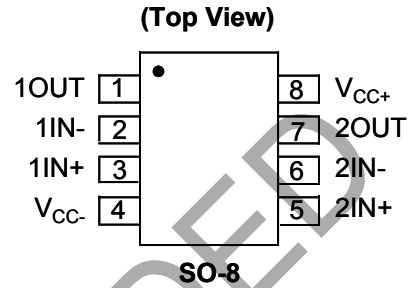

Features

- Unity-Gain Bandwidth . . . 3 MHz typical
- Gain and Phase match between amplifiers
- Low Noise . . . 8 nV/ $\sqrt{\text{Hz}}$ typical at 1 kHz
- Wide Common-Mode and Differential voltage ranges
- No frequency compensation required
- Low power consumption
- No latch-up
- Green mold compound (No Br, Sb) (Note 1)

Applications

- Audio pre amps
- RCA line out buffers

Notes: 1. EU Directive 2002/95/EC (RoHS). All applicable RoHS exemptions applied. Please visit our website at http://www.diodes.com/products/lead_free.html.

Schematic Diagram

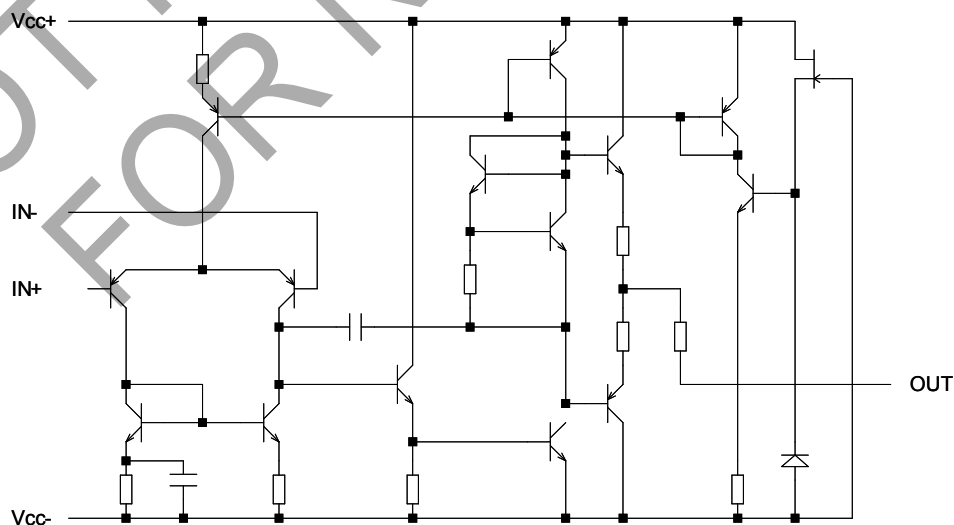

Pin Descriptions

Pin #	Name	Description
1	1OUT	Amplifier 1 output
2	1IN-	Amplifier 1 inverting input
3	1IN+	Amplifier 1 non-inverting input
4	V _{CC-}	Negative supply pin for amplifier 1 and amplifier 2
5	2IN+	Amplifier 2 non-inverting input
6	2IN-	Amplifier 2 inverting input
7	2OUT	Amplifier 2 output
8	V _{CC+}	Positive supply pin for amplifier 1 and amplifier 2.

Absolute Maximum Ratings (Note 2)

Symbol	Parameter	Rating	Unit
V _{CC+}	Supply voltage (Note 3)	18	V
V _{CC-}		-18	
V _{ID}	Differential input voltage (Note 4)	±30	V
V _I	Input voltage (any input) (Note 3, 5)	±15	V
	Duration of output short circuit to ground, one amplifier at a time (Note 6)	Unlimited	
T _J	Junction Temperature (Note 7)	150	°C
T _{STG}	Storage Temperature	-65 to 150	°C

- Notes:
- Stresses beyond those listed under Absolute Maximum Ratings may cause permanent damage to the device. These are stress ratings only, and functional operation of the device at these or any other conditions beyond those indicated under Recommended Operating Conditions is not implied. Exposure to absolute-maximum-rated conditions for extended periods may affect device reliability.
 - All voltage values, unless otherwise noted, are with respect to the midpoint between V_{CC+} and V_{CC-}.
 - Differential voltages are at IN+ with respect to IN-.
 - The magnitude of the input voltage must never exceed the magnitude of the supply voltage or 15 V, whichever is less.
 - Temperature and/or supply voltages must be limited to ensure that the dissipation rating is not exceeded.
 - Maximum power dissipation is a function of T_J (max), θ_{JA}, and T_A. The maximum allowable power dissipation at any allowable ambient temperature is P_D = (T_J (max) - T_A)/θ_{JA}. Operating at the absolute maximum T_J of 150°C can affect reliability.

Recommended Operating Conditions

Symbol	Parameter		Min	Max	Unit
V _{CC+}	Supply voltage (Note 3)		5	15	V
V _{CC-}			-5	-15	
T _A	Operating Ambient	APX4558	0	70	°C
	Temperature Range	APX4558I	-40	105	

Electrical Characteristics ($V_{CC\pm} = \pm 15V$, $T_A = 25C$, unless otherwise stated)

Symbol	Parameter	Conditions	T_A	Min	Typ.	Max	Unit
AC Characteristics							
V_{IO}	Input offset voltage	$V_O = 0V$	25°C		0.5	6	mV
			Full temp			7.5	
I_{IO}	Input offset current	$V_O = 0V$	25°C		5	200	nA
			Full temp			300	
I_{IB}	Input bias current	$V_O = 0V$	25°C		150	500	nA
			Full temp			800	
V_{ICR}	Common-mode input voltage range		25°C	± 12	± 14		V
V_{OM}	Maximum output voltage swing	$R_L = 10k\Omega$	25°C	± 12	± 14		V
			25°C	± 10	± 13		
			Full temp	± 10			
A_{VD}	Large-signal differential voltage amplification	$R_L \geq 2k\Omega$ $V_O = \pm 10V$	25°C	20	300		V/mV
			Full temp	15			
R_{IN}	Input resistance		25°C	0.3	5		M Ω
CMRR	Common-mode rejection ratio	$V_{IN} = V_{ICR(Min)}$	25°C	70	90		dB
PSRR	Power supply rejection ratio	$V_{CC\pm} = \pm 15V$ to $\pm 9V$	25°C	76	90		dB
I_{CC}	Supply current both amplifiers	$V_O = 0V$, No load	25°C		2.5	5.6	mA
			T_A min		3	6.6	
			T_A max		2.3	5	
AC Characteristics							
B_1	Unity-gain bandwidth		25°C		3		MHz
SR	Slew rate at unity gain	$V_I = \pm 10V$, $R_L = 2k\Omega$, $C_L = 100pF$	25°C	1.1	1.7		V/ μs
v_n	Equivalent input noise voltage (closed loop)	$G=100$, $R_S = 100\Omega$ $F = 1kHz$, $BW = 1Hz$	25°C		8		nV/ \sqrt{Hz}
V_{O1}/V_{O2}	Crosstalk attenuation	Open loop	25°C		85		dB
		$G = 100$		$R_S = 1k\Omega$ $f = 10kHz$		105	
t_r	Rise time overshoot	$V_I = 20mV$, $R_L = 2k\Omega$, $C_L = 100pF$	25°C		0.13		μs
			25°C		5		%
Power and Thermal Characteristics							
P_D	Total power dissipation both amplifiers	$V_O = 0V$, No load	25°C		75	170	mW
			T_A min		90	200	
			T_A max		70	150	
θ_{JA}	Thermal Resistance Junction-to-Ambient	SO-8 (Note 8)			130		°C/W
θ_{JC}	Thermal Resistance Junction-to-Case	SO-8 Note 8)			15		°C/W

Notes: 8. Test condition for SO-8: Device mounted on FR-4 substrate PC board, with minimum recommended pad layout
 9. Full temp is specified as 0 to 70°C for the APX4558 and -40 to 105°C for the APX48558I

Typical Performance Characteristics

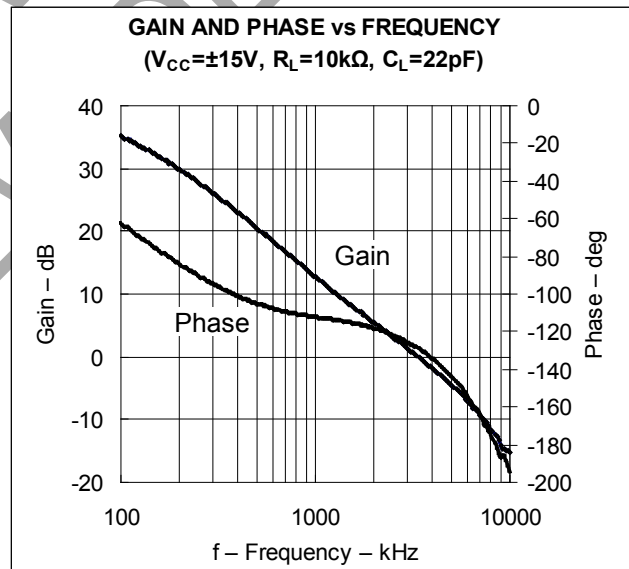
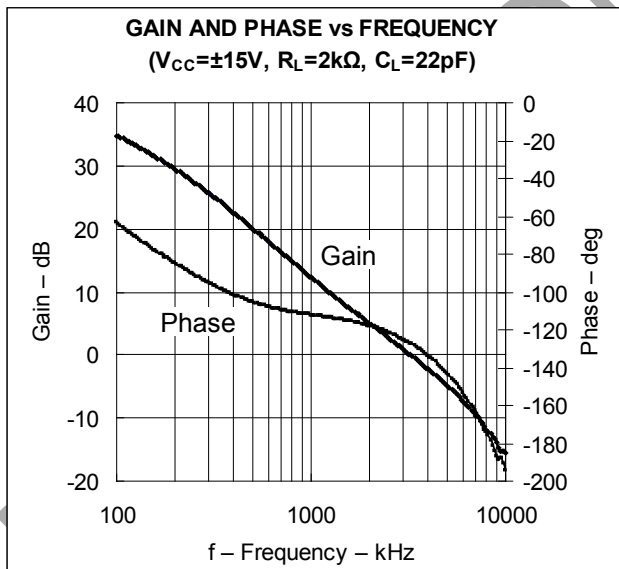
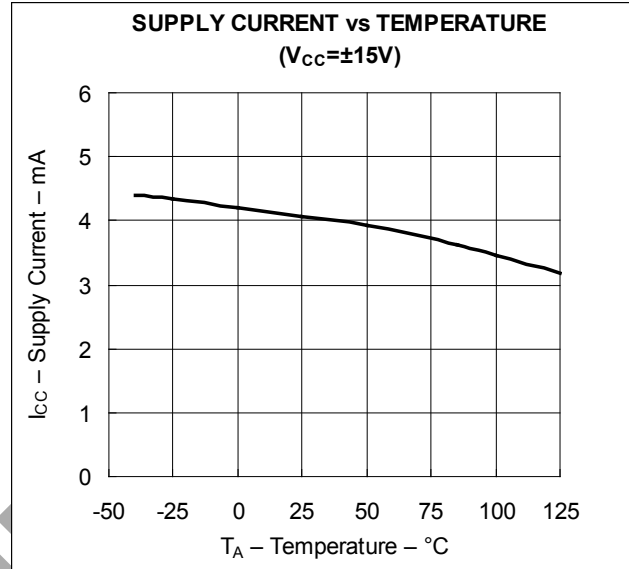
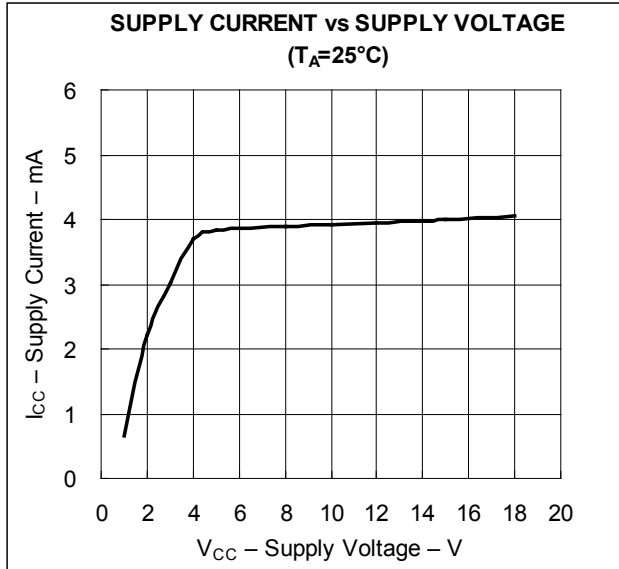

Typical Performance Characteristics (Continued)

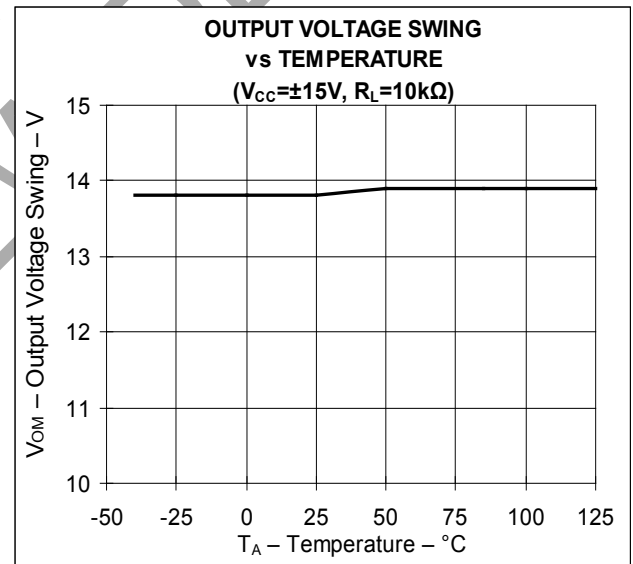
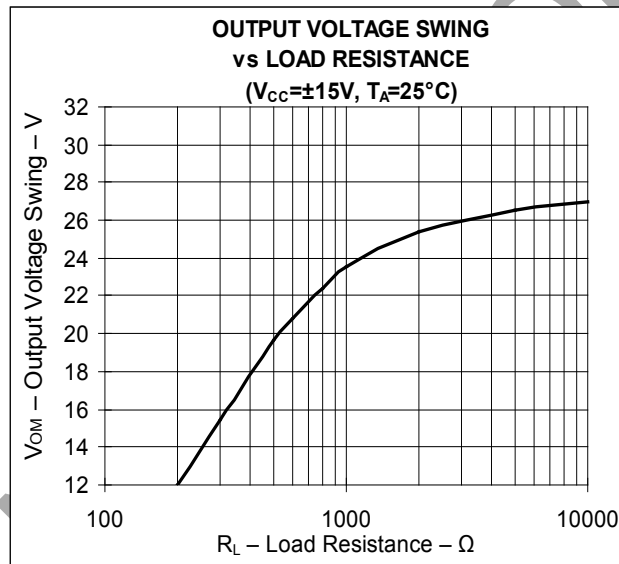
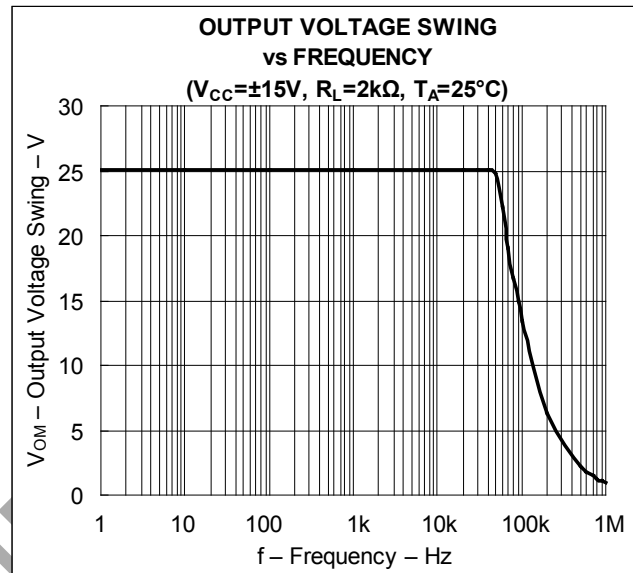
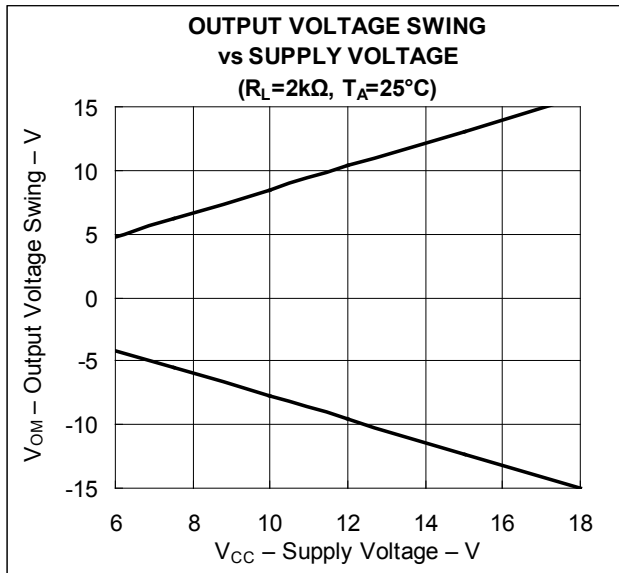

Typical Performance Characteristics (Continued)

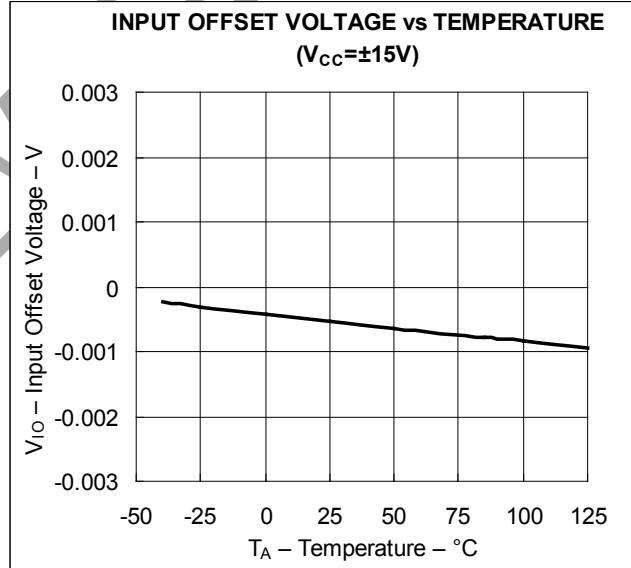
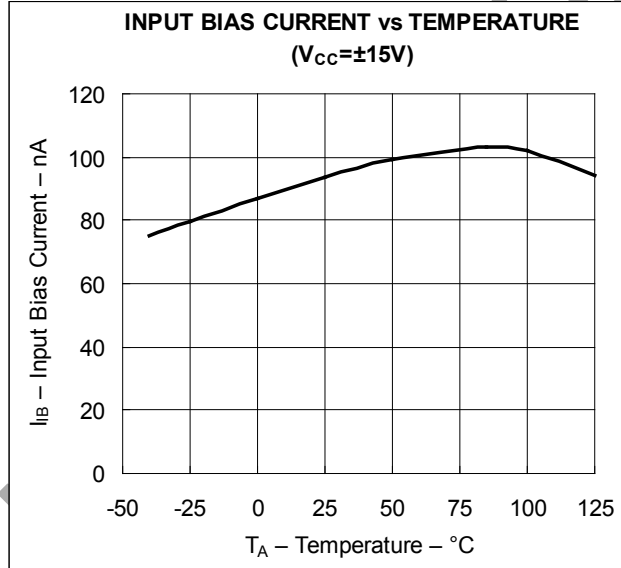
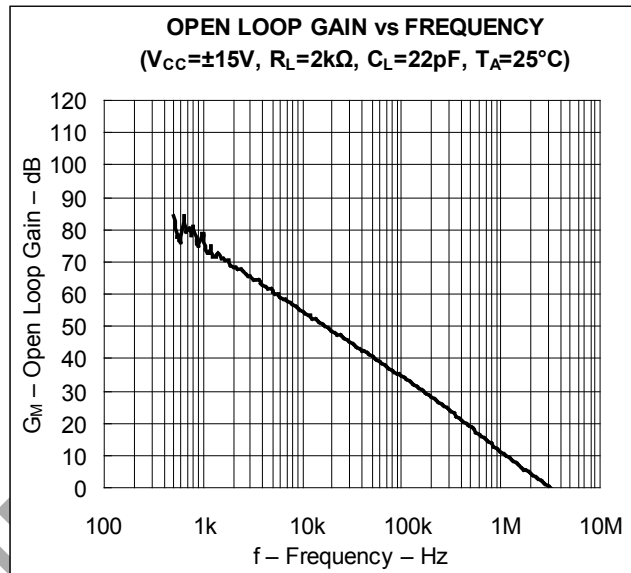
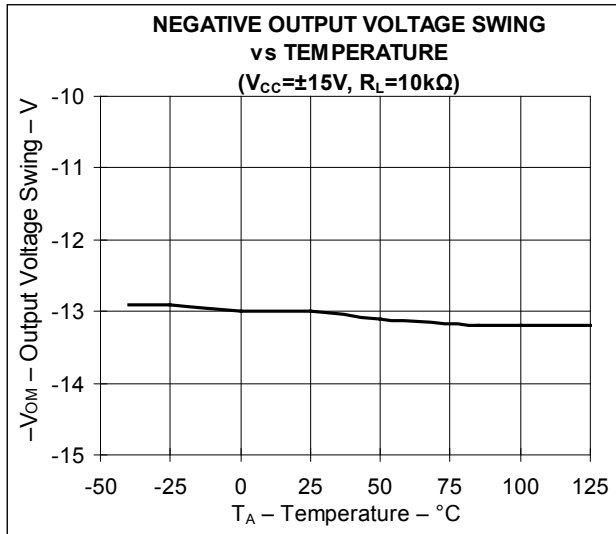

Typical Performance Characteristics (Continued)

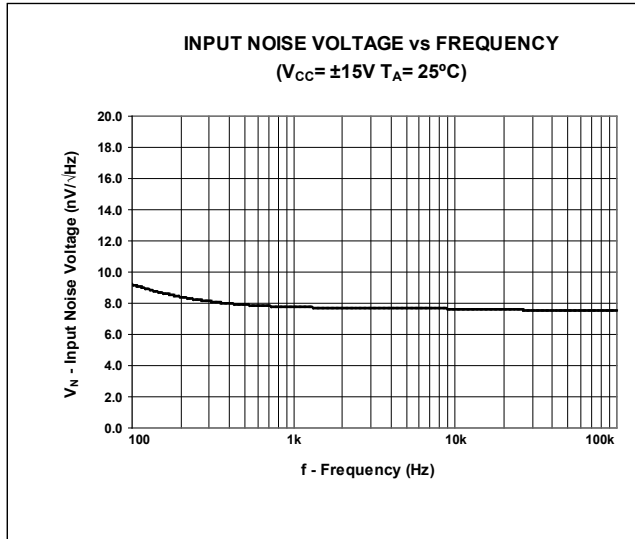

NOT RECOMMENDED
FOR NEW DESIGN

Ordering Information

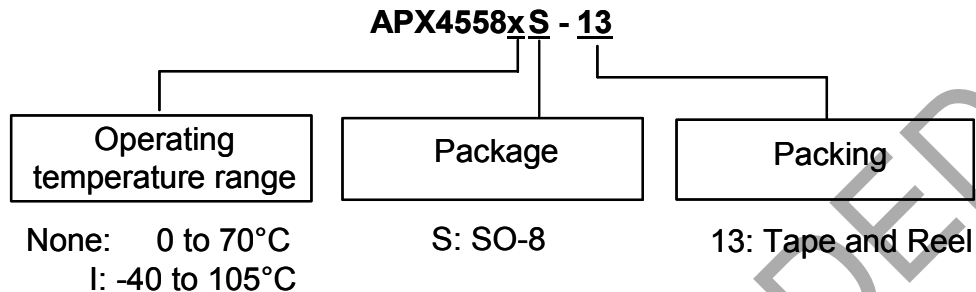

Device	Package Code	Packaging (Note 10)	13" Tape and Reel	
			Quantity	Part Number Suffix
APX4558S-13	S	SO-8	2500/Tape & Reel	-13
APX4558IS-13	S	SO-8	2500/Tape & Reel	-13

Notes: 10. Pad layout as shown on Diodes Inc. suggested pad layout document AP02001, which can be found on our website at <http://www.diodes.com/datasheets/ap02001.pdf>.

Marking Information

SO-8

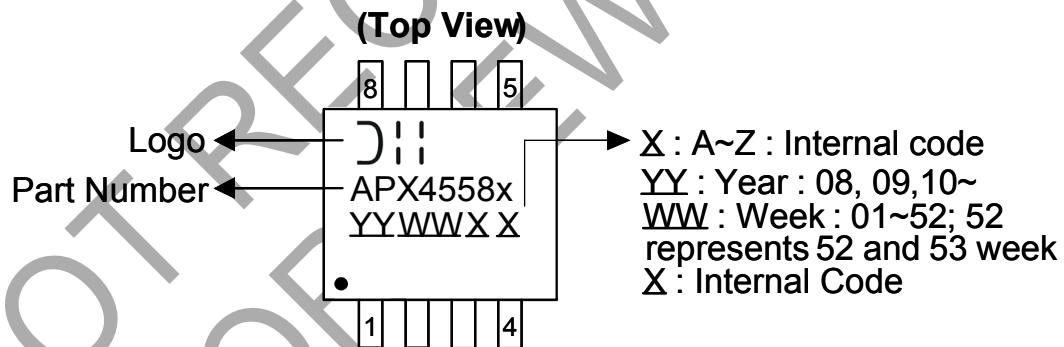

Package Outline Dimensions (All Dimensions in mm)

SO-8

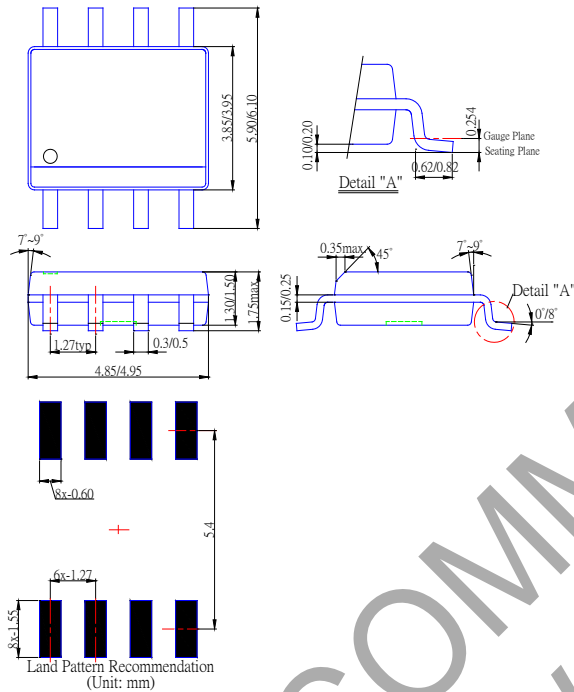

NOT RECOMMENDED
FOR NEW DESIGN

**DUAL CHANNEL LOW NOISE GENERAL PURPOSE
OPERATIONAL AMPLIFIER****IMPORTANT NOTICE**

1. DIODES INCORPORATED AND ITS SUBSIDIARIES (“DIODES”) MAKE NO WARRANTY OF ANY KIND, EXPRESS OR IMPLIED, WITH REGARDS TO ANY INFORMATION CONTAINED IN THIS DOCUMENT, INCLUDING, BUT NOT LIMITED TO, THE IMPLIED WARRANTIES OF MERCHANTABILITY, FITNESS FOR A PARTICULAR PURPOSE OR NON-INFRINGEMENT OF THIRD PARTY INTELLECTUAL PROPERTY RIGHTS (AND THEIR EQUIVALENTS UNDER THE LAWS OF ANY JURISDICTION).

2. The Information contained herein is for informational purpose only and is provided only to illustrate the operation of Diodes products described herein and application examples. Diodes does not assume any liability arising out of the application or use of this document or any product described herein. This document is intended for skilled and technically trained engineering customers and users who design with Diodes products. Diodes products may be used to facilitate safety-related applications; however, in all instances customers and users are responsible for (a) selecting the appropriate Diodes products for their applications, (b) evaluating the suitability of the Diodes products for their intended applications, (c) ensuring their applications, which incorporate Diodes products, comply the applicable legal and regulatory requirements as well as safety and functional-safety related standards, and (d) ensuring they design with appropriate safeguards (including testing, validation, quality control techniques, redundancy, malfunction prevention, and appropriate treatment for aging degradation) to minimize the risks associated with their applications.

3. Diodes assumes no liability for any application-related information, support, assistance or feedback that may be provided by Diodes from time to time. Any customer or user of this document or products described herein will assume all risks and liabilities associated with such use, and will hold Diodes and all companies whose products are represented herein or on Diodes' websites, harmless against all damages and liabilities.

4. Products described herein may be covered by one or more United States, international or foreign patents and pending patent applications. Product names and markings noted herein may also be covered by one or more United States, international or foreign trademarks and trademark applications. Diodes does not convey any license under any of its intellectual property rights or the rights of any third parties (including third parties whose products and services may be described in this document or on Diodes' website) under this document.

5. Diodes products are provided subject to Diodes' Standard Terms and Conditions of Sale (<https://www.diodes.com/about/company/terms-and-conditions/terms-and-conditions-of-sales/>) or other applicable terms. This document does not alter or expand the applicable warranties provided by Diodes. Diodes does not warrant or accept any liability whatsoever in respect of any products purchased through unauthorized sales channel.

6. Diodes products and technology may not be used for or incorporated into any products or systems whose manufacture, use or sale is prohibited under any applicable laws and regulations. Should customers or users use Diodes products in contravention of any applicable laws or regulations, or for any unintended or unauthorized application, customers and users will (a) be solely responsible for any damages, losses or penalties arising in connection therewith or as a result thereof, and (b) indemnify and hold Diodes and its representatives and agents harmless against any and all claims, damages, expenses, and attorney fees arising out of, directly or indirectly, any claim relating to any noncompliance with the applicable laws and regulations, as well as any unintended or unauthorized application.

7. While efforts have been made to ensure the information contained in this document is accurate, complete and current, it may contain technical inaccuracies, omissions and typographical errors. Diodes does not warrant that information contained in this document is error-free and Diodes is under no obligation to update or otherwise correct this information. Notwithstanding the foregoing, Diodes reserves the right to make modifications, enhancements, improvements, corrections or other changes without further notice to this document and any product described herein. This document is written in English but may be translated into multiple languages for reference. Only the English version of this document is the final and determinative format released by Diodes.

8. Any unauthorized copying, modification, distribution, transmission, display or other use of this document (or any portion hereof) is prohibited. Diodes assumes no responsibility for any losses incurred by the customers or users or any third parties arising from any such unauthorized use.

Copyright © 2021 Diodes Incorporated

www.diodes.com