

Description

The AS393/393A consist of two independent precision voltage comparators with a typical offset voltage of 1.0mV and high gain. They are specifically designed to operate from a single power supply over wide range of voltages. Operation from split power supply is also possible and the low power supply current drain is independent of the magnitude of the power supply voltage.

The AS393/393A series are compatible with industry standard 393. The AS393A has more stringent input offset voltage than the AS393.

The AS393 is available in standard PDIP-8, SO-8, TSSOP-8 and MSOP-8 packages. The AS393A is available in standard PDIP-8 and SO-8 packages.

Features

- Wide Supply Voltage Range
 - Single Supply: 2V to 36V
 - Dual Supplies: $\pm 1.0V$ to $\pm 18V$
- Low Supply Current Drain: 0.6mA
- Low Input Bias Current: 25nA (typical)
- Low Input Offset Current: $\pm 5.0nA$ (typical)
- Low Input Offset Voltage: 1.0mV (typical)
- Input Common Mode Voltage Range Includes Ground
- Differential Input Voltage Range Equals to the Power Supply Voltage
- Low Output Saturation Voltage: 200mV at 4mA
- Open Collector Output
- Lead-Free Packages: SO-8, TSSOP-8, PDIP-8
 - **Totally Lead-Free; RoHS Compliant (Notes 1 & 2)**
- Lead-Free Packages, Available in "Green" Molding Compound: SO-8, TSSOP-8, MSOP-8
 - **Totally Lead-Free & Fully RoHS Compliant (Notes 1 & 2)**
 - **Halogen and Antimony Free. "Green" Device (Note 3)**
- **For automotive applications requiring specific change control (i.e. parts qualified to AEC-Q100/101/104/200, PPAP capable, and manufactured in IATF 16949 certified facilities), please [contact us](https://www.diodes.com/quality/product-definitions/) or your local Diodes representative. <https://www.diodes.com/quality/product-definitions/>**

- Notes:
1. No purposely added lead. Fully EU Directive 2002/95/EC (RoHS), 2011/65/EU (RoHS 2) & 2015/863/EU (RoHS 3) compliant.
 2. See <https://www.diodes.com/quality/lead-free/> for more information about Diodes Incorporated's definitions of Halogen- and Antimony-free, "Green" and Lead-free.
 3. Halogen- and Antimony-free "Green" products are defined as those which contain <900ppm bromine, <900ppm chlorine (<1500ppm total Br + Cl) and <1000ppm antimony compounds.

Pin Assignments

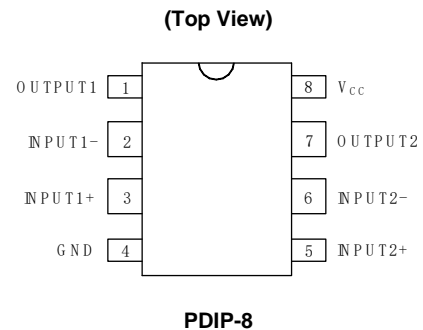
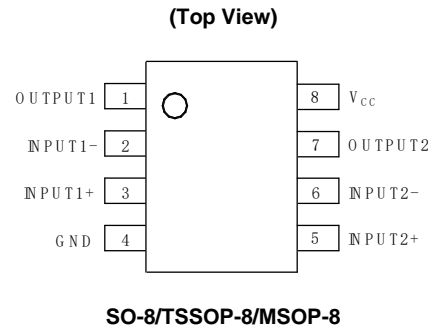

Applications

- Battery chargers
- Cordless telephones
- Switching power supplies
- DC-DC modules
- PC motherboards
- Communication equipment

Typical Applications Circuit

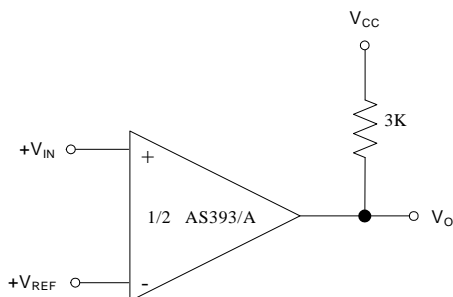

Basic Comparator

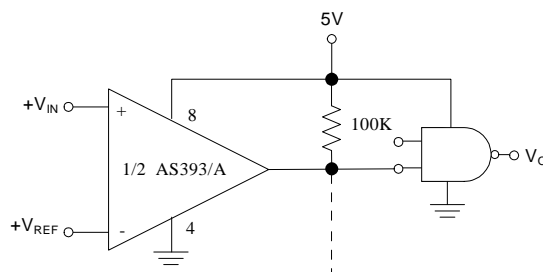

Driving CMOS

Absolute Maximum Ratings (Note 4)

Symbol	Parameter	Rating	Unit	
V_{CC}	Supply Voltage	40	V	
V_{ID}	Differential Input Voltage	40	V	
V_{IN}	Input Voltage	-0.3 to 40	V	
I_{IN}	Input Current ($V_{IN} < -0.3V$) (Note 5)	50	mA	
—	Output Short-Circuit Current to Ground	Continuous	—	
P_D	Power Dissipation ($T_A = +25^\circ C$)	PDIP-8	780	mW
		SOIC-8	660	
		TSSOP-8	570	
		MSOP-8	450	
T_J	Operating Junction Temperature	+150	$^\circ C$	
T_{STG}	Storage Temperature	-65 to +150	$^\circ C$	
T_{LEAD}	Lead Temperature (Soldering, 10 Seconds)	+260	$^\circ C$	

Notes: 4. Stresses greater than those listed under "Absolute Maximum Ratings" can cause permanent damage to the device. These are stress ratings only, and functional operation of the device at these or any other conditions beyond those indicated under "Recommended Operating Conditions" is not implied. Exposure to "Absolute Maximum Ratings" for extended periods can affect device reliability.

5. This input current will only exist when the voltage at any of the input leads is driven negative. It is due to the collector-base junction of the input PNP transistors becoming forward biased and thereby acting as input diode clamps. In addition to this diode action, there is also lateral NPN parasitic transistor action on the IC chip. This transistor action can cause the output voltages of the comparators to go to the $V+$ voltage level (or to ground for a large overdrive) for the time duration that an input is driven negative. This is not destructive and normal output states will re-establish when the input voltage, which was negative, again returns to a value greater than $-0.3 V_{DC}$ (at $+25^\circ C$).

Recommended Operating Conditions

Symbol	Parameter	Min	Max	Unit
V_{CC}	Supply Voltage	2	36	V
T_A	Operating Temperature Range	-40	+85	$^\circ C$

Electrical Characteristics (Limits in standard typeface are for $T_A = +25^\circ\text{C}$, **bold** typeface applies over $T_A = -40^\circ\text{C}$ to $+85^\circ\text{C}$ (Note 6), $V_{CC} = 5\text{V}$, $\text{GND} = 0\text{V}$, unless otherwise specified.)

Parameter	Conditions		Min	Typ	Max	Unit
Input Offset Voltage	$V_O = 1.4\text{V}$, $R_S = 0\Omega$, $V_{CC} = 5\text{V}$ to 30V	AS393	—	1.0	5.0	mV
			—	—	7	
		AS393A	—	1.0	3.0	
			—	—	5	
Input Bias Current	I_{IN+} or I_{IN-} with output in linear range, $V_{CM} = 0\text{V}$	—	25	250	nA	
		—	—	400		
Input Offset Current	$I_{IN+} - I_{IN-}$, $V_{CM} = 0\text{V}$	—	5.0	50	nA	
		—	—	200		
Input Common Mode Voltage Range (Note 7)	$V_{CC} = 30\text{V}$		0	—	$V_{CC} - 1.5$	V
Supply Current	$R_L = \infty$	$V_{CC} = 5\text{V}$	—	0.4	1.0	mA
			—	—	2	
		$V_{CC} = 30\text{V}$	—	0.7	1.7	
			—	—	3	
Voltage Gain	$V_{CC} = 15\text{V}$, $R_L \geq 15\text{k}\Omega$, $V_O = 1\text{V}$ to 11V		50	200	—	V/mV
Large Signal Response Time	$V_{IN} = \text{TTL Logic Swing}$, $V_{REF} = 1.4\text{V}$, $V_{RL} = 5\text{V}$, $R_L = 5.1\text{k}$		—	200	—	ns
Response Time	$V_{RL} = 5\text{V}$, $R_L = 5.1\text{k}$		—	1.3	—	μs
Output Sink Current	$V_{IN-} = 1\text{V}$, $V_{IN+} = 0\text{V}$, $V_O = 1.5\text{V}$		6.0	16	—	mA
Output Leakage Current	$V_{IN-} = 0\text{V}$, $V_{IN+} = 1\text{V}$, $V_O = 5\text{V}$		—	0.1	—	nA
	$V_{IN-} = 0\text{V}$, $V_{IN+} = 1\text{V}$, $V_O = 30\text{V}$		—	—	1	μA
Saturation Voltage	$V_{IN-} = 1\text{V}$, $V_{IN+} = 0$, $I_{SINK} \leq 4\text{mA}$		—	200	400	mV
			—	—	500	
Thermal Resistance (Junction to Case)	SO-8		—	9	—	$^\circ\text{C/W}$
	TSSOP-8		—	15	—	
	MSOP-8		—	24	—	
Thermal Resistance (Junction to Ambient)	SO-8		—	108	—	
	TSSOP-8		—	179	—	
	MSOP-8		—	151	—	

Notes: 6. These specifications are limited to $-40^\circ\text{C} \leq T_A \leq +85^\circ\text{C}$. Limits over temperature are guaranteed by design, but not tested in production.
7. The input common-mode voltage of either input signal voltage should not be allowed to go negatively by more than 0.3V (at $+25^\circ\text{C}$). The upper end of the common-mode voltage range is $V_{CC} - 1.5\text{V}$ (at $+25^\circ\text{C}$), but either or both inputs can go to $+36\text{V}$ without damages, independent of the magnitude of the V_{CC} .

Performance Characteristics

Supply Voltage vs. Supply Current

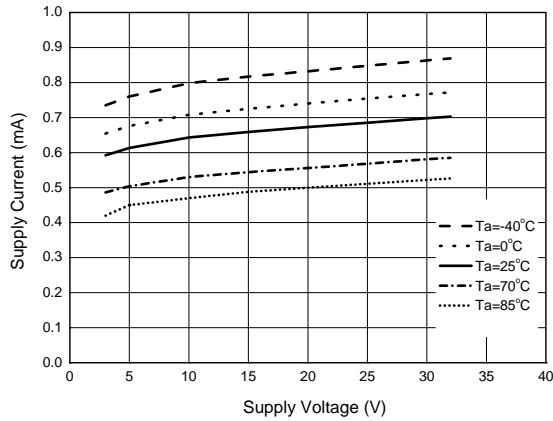

Supply Voltage vs. Input Bias Current

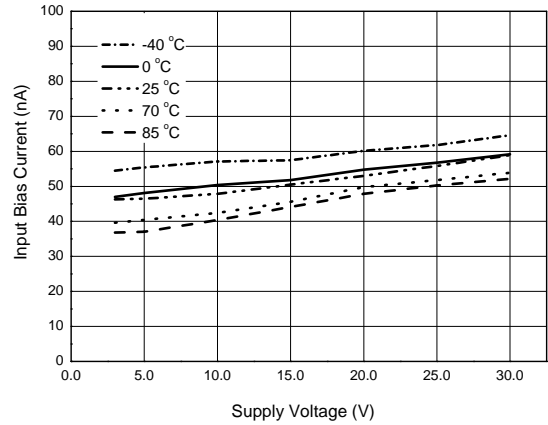

Output Sink Current vs. Saturation Voltage

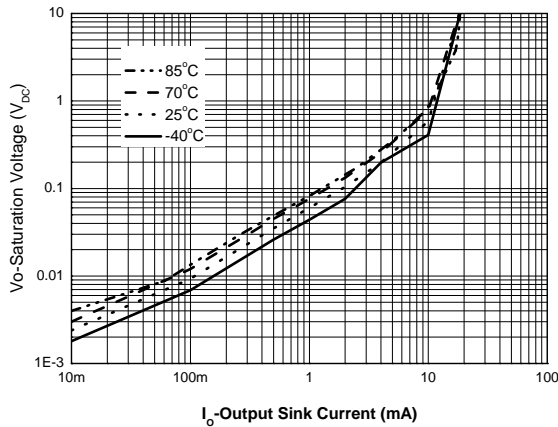

Response Time for 5mV Input Overdrive – Negative Transition

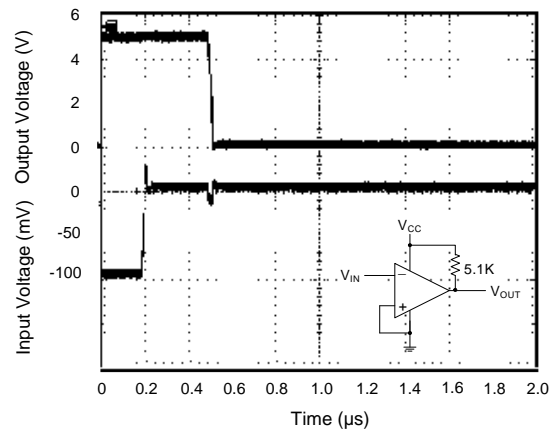



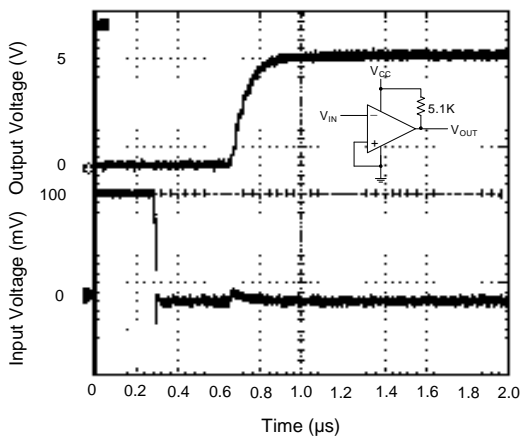



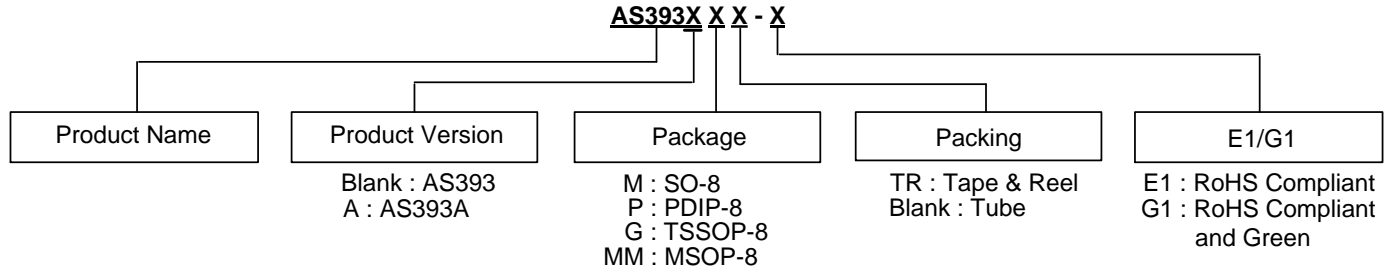

Response Time for 5mV Input Overdrive – Positive Transition



Ordering Information



Orderable Part Number	Package (Note 9)	RoHS Compliant Lead Free / Green	Marking ID	Packing		Status (Note 8)	Alternative
				Qty.	Carrier		
 AS393MTR-E1	SO-8	Lead Free	AS393M-E1	4000	Tape & Reel	NRND	AS393MTR-G1
 AS393MTR-G1		Green	AS393M-G1	4000	Tape & Reel	In Production	—
 AS393AMTR-E1		Lead Free	AS393AM-E1	4000	Tape & Reel	NRND	AS393AMTR-G1
 AS393AMTR-G1		Green	AS393AM-G1	4000	Tape & Reel	In Production	—
 AS393P-E1	PDIP-8	Lead Free	AS393P-E1	50	Tube	NRND	—
 AS393AP-E1		Lead Free	AS393AP-E1	50	Tube	NRND	—
 AS393GTR-E1	TSSOP-8	Lead Free	EG3C	4000	Tape & Reel	NRND	—
 AS393GTR-G1		Green	GG3C	4000	Tape & Reel	EOL	—
 AS393MMTR-G1	MSOP-8	Green	AS393MM-G1	2500	Tape & Reel	In Production	—

Notes: 8. All variants in TDIP-8 package are End of life without replacements.
 NRND: Not Recommended for New Design.
 9. For packaging details, go to our website at: <https://www.diodes.com/design/support/packaging/diodes-packaging/>.

Marking Information

(1) SO-8

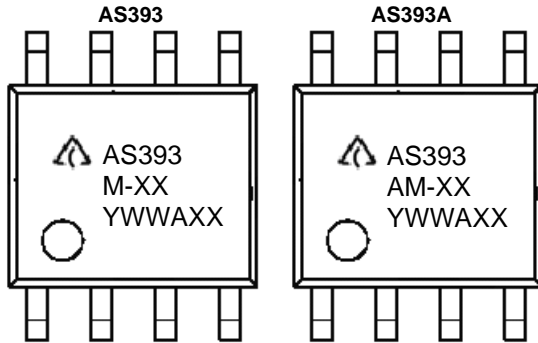

First and Second Lines: Logo and Marking ID
(See Ordering Information)
Third Line: Date Code
Y: Year
WW: Work Week of Molding
A: Assembly House Code
XX: Internal Code

(2) MSOP-8

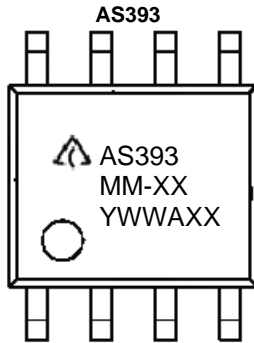

First and Second Lines: Logo and Marking ID
(See Ordering Information)
Third Line: Date Code
Y: Year
WW: Work Week of Molding
A: Assembly House Code
XX: Internal Code

(3) PDIP-8

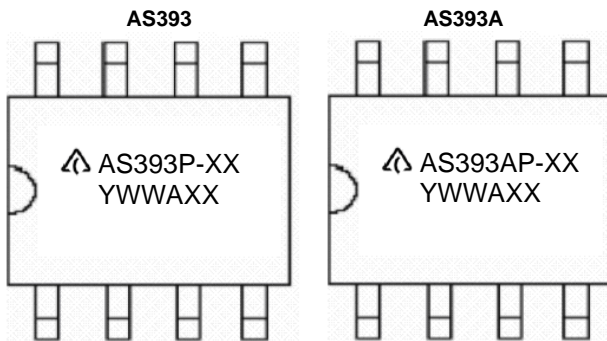

First Line: Logo and Marking ID (See Ordering Information)
Second Line: Date Code
Y: Year
WW: Work Week of Molding
A: Assembly House Code
XX: Internal Code

(4) TSSOP-8

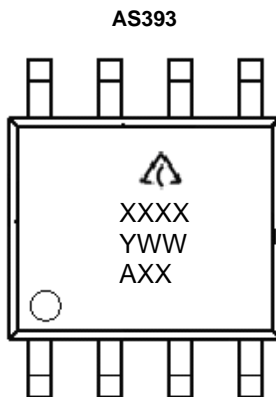

First Line: Logo
Second Line: Marking ID (See Ordering Information)
Third and Fourth Lines: Date Code
Y: Year
WW: Work Week of Molding
A: Assembly House Code
XX: Internal Code

Package Outline Dimensions (All dimensions in mm(inch).)

Please see <http://www.diodes.com/package-outlines.html> for the latest version.

(1) Package Type: PDIP-8

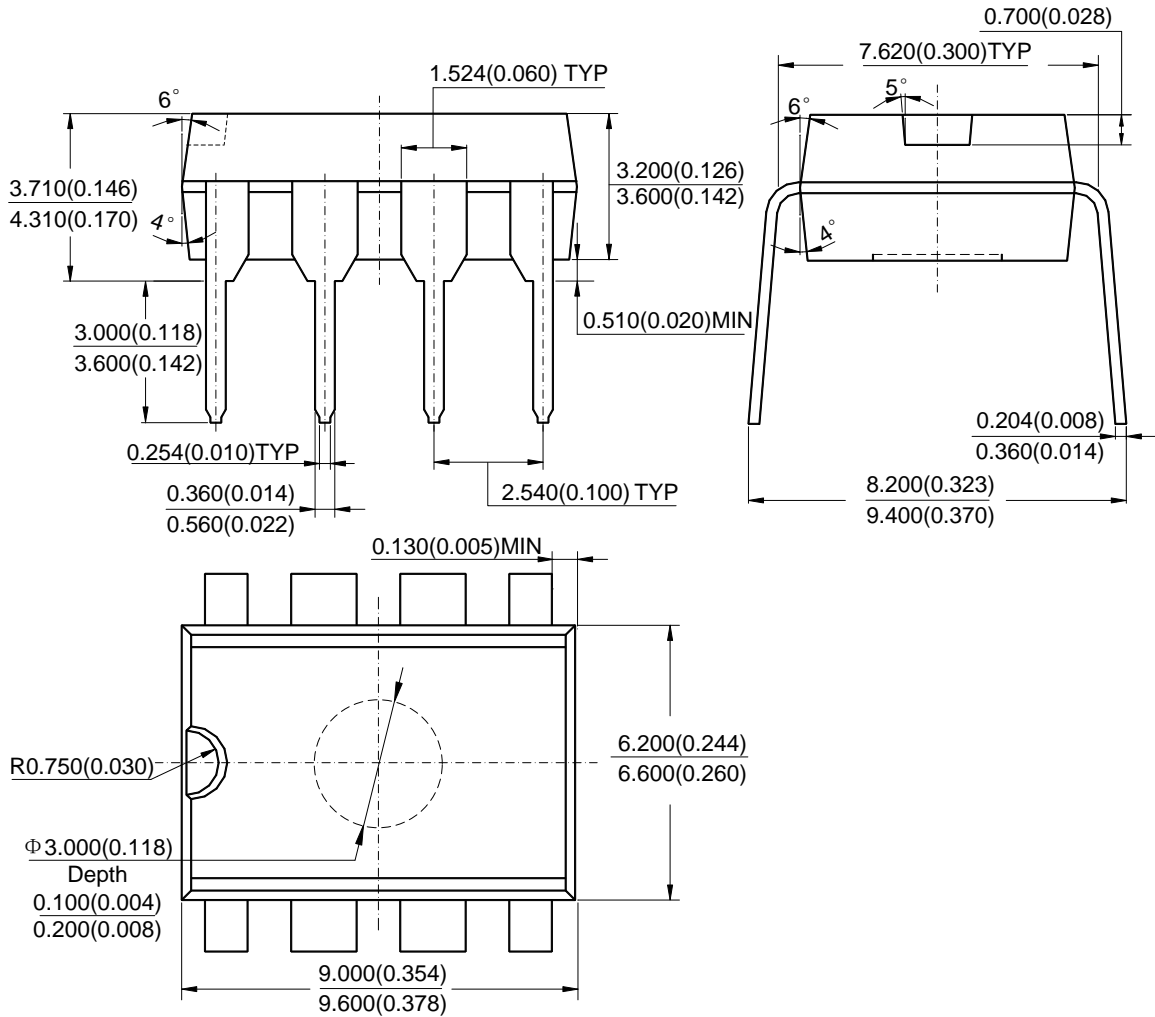

Note: Eject hole, oriented hole and mold mark is optional.

Package Outline Dimensions (Continued. All dimensions in mm(inch).)

Please see <http://www.diodes.com/package-outlines.html> for the latest version.

(2) Package Type: SO-8

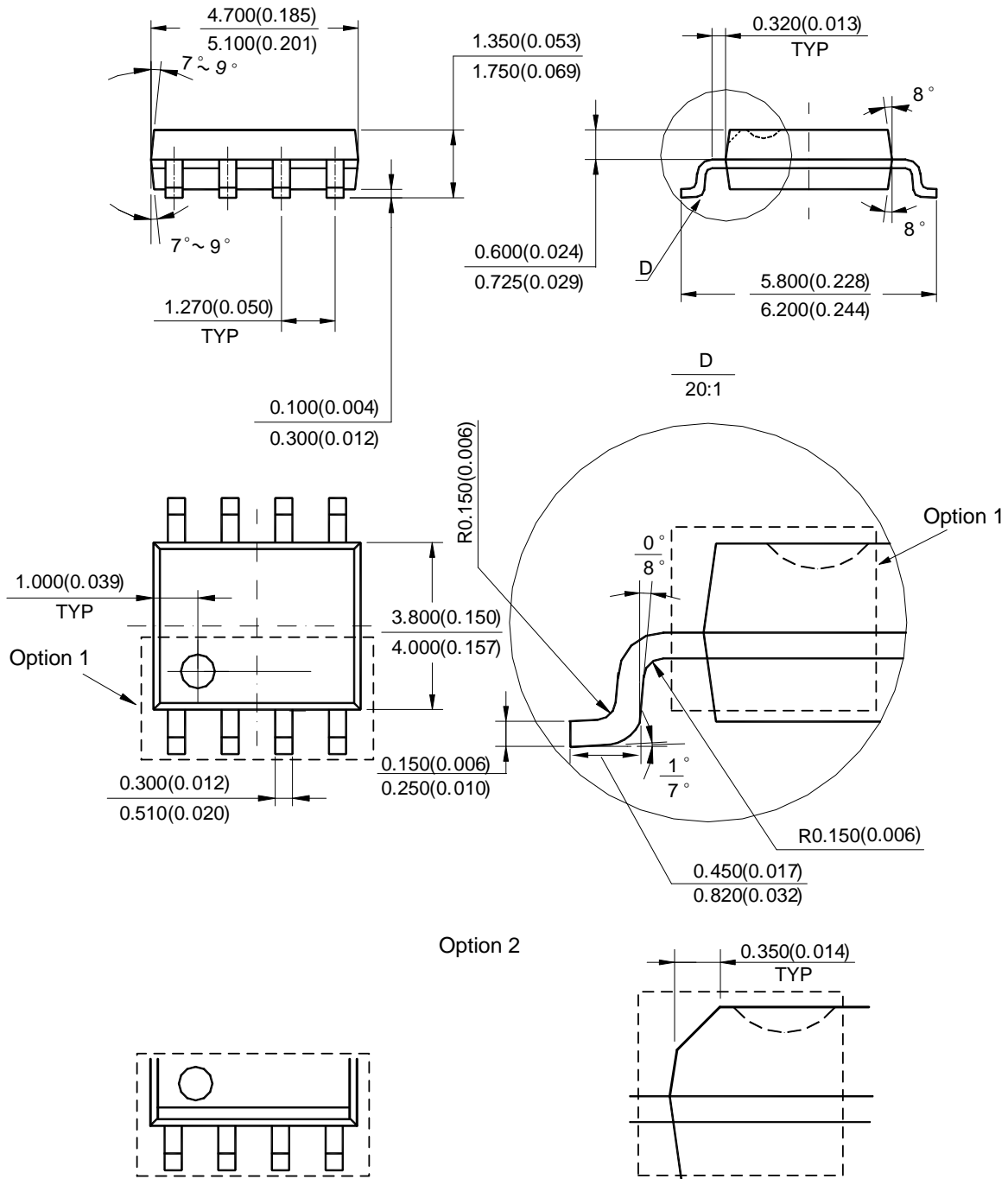

Note: Eject hole, oriented hole and mold mark is optional.

Package Outline Dimensions (Continued. All dimensions in mm(inch).)

Please see <http://www.diodes.com/package-outlines.html> for the latest version.

(3) Package Type: TSSOP-8

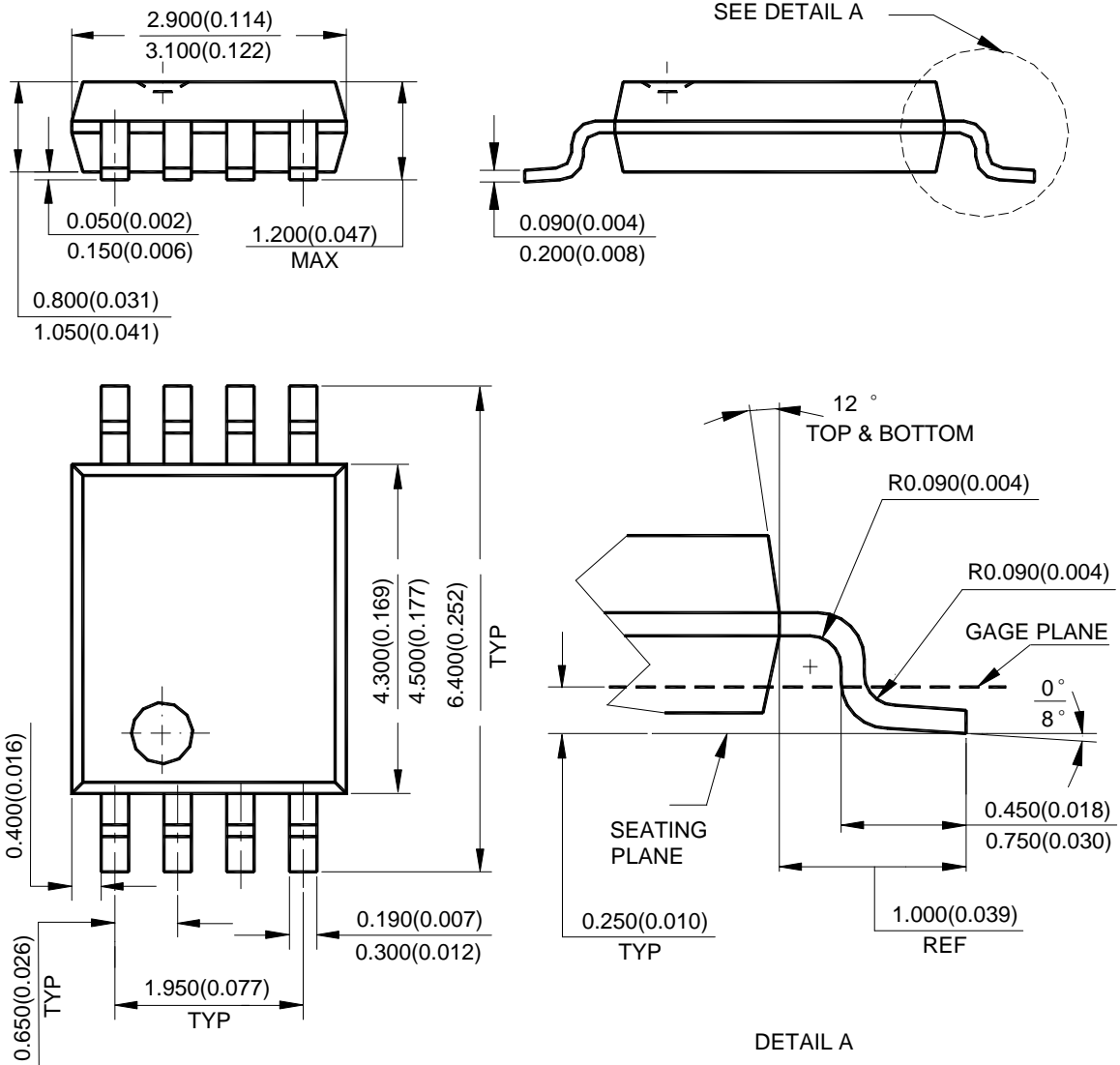

Note: Eject hole, oriented hole and mold mark is optional.

Package Outline Dimensions (Continued. All dimensions in mm(inch).)

Please see <http://www.diodes.com/package-outlines.html> for the latest version.

(4) Package Type: MSOP-8

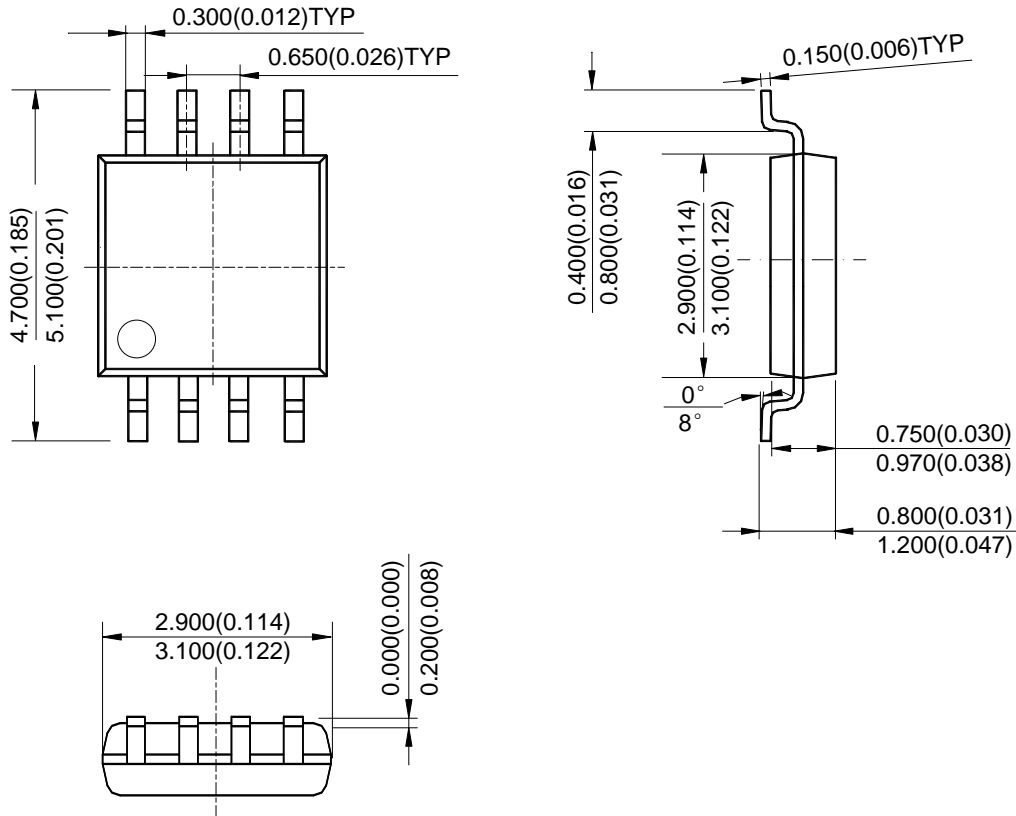

Note: Eject hole, oriented hole and mold mark is optional.

Suggested Pad Layout

Please see <http://www.diodes.com/package-outlines.html> for the latest version.

(1) Package Type: SO-8

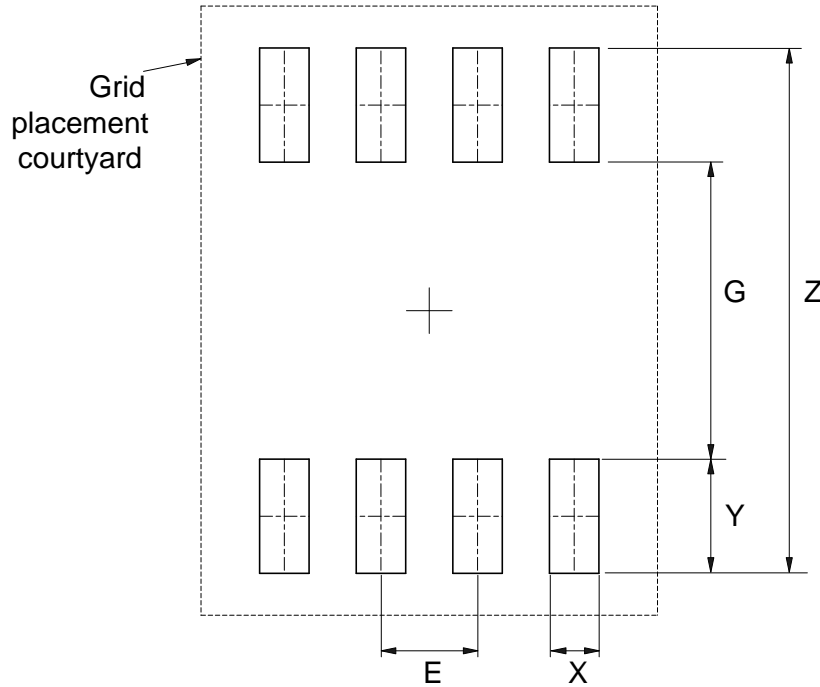

Dimensions	Z (mm)/(inch)	G (mm)/(inch)	X (mm)/(inch)	Y (mm)/(inch)	E (mm)/(inch)
Value	6.900/0.272	3.900/0.154	0.650/0.026	1.500/0.059	1.270/0.050

Suggested Pad Layout (continued)

Please see <http://www.diodes.com/package-outlines.html> for the latest version.

(2) Package Type: TSSOP-8

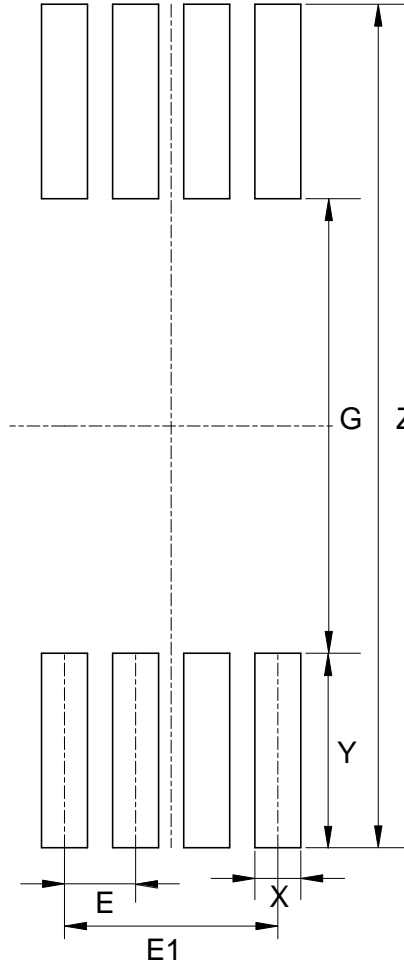

Dimensions	Z (mm)/(inch)	G (mm)/(inch)	X (mm)/(inch)	Y (mm)/(inch)	E (mm)/(inch)	E1 (mm)/(inch)
Value	7.720/0.304	4.160/0.164	0.420/0.017	1.780/0.070	0.650/0.026	1.950/0.077

Suggested Pad Layout (continued)

Please see <http://www.diodes.com/package-outlines.html> for the latest version.

(3) Package Type: MSOP-8

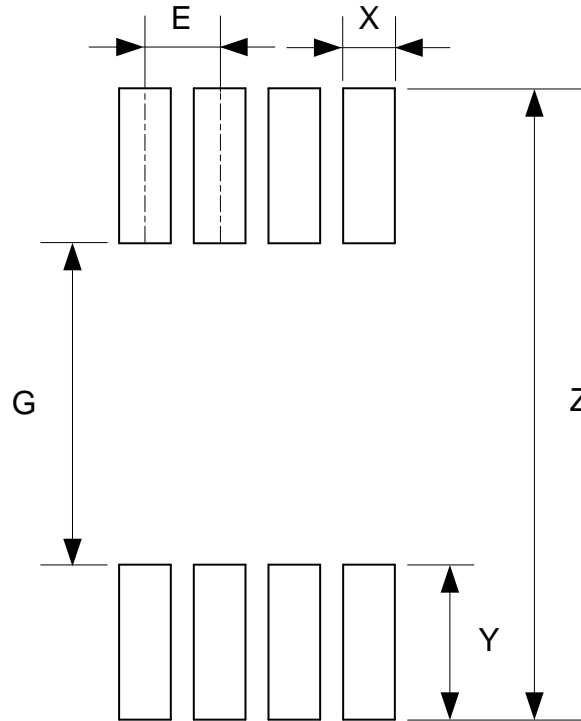

Dimensions	Z (mm)/(inch)	G (mm)/(inch)	X (mm)/(inch)	Y (mm)/(inch)	E (mm)/(inch)
Value	5.500/0.217	2.800/0.110	0.450/0.018	1.350/0.053	0.650/0.026

Mechanical Data

- Moisture Sensitivity:
SO-8: Level 1 (CAT) Level 3 (SAT) per J-STD-020
MSOP-8: Level 1 (CAT) Level 3 (SAT) per J-STD-020
TSSOP-8: Level 3
- Terminals: Finish – Matte Tin Plated Leads, Solderable per MIL-STD-202, Method 208 [Ⓜ]
- Weight:
SO-8: 0.076 grams (Approximate)
MSOP-8: 0.0274 grams (Approximate)
TSSOP-8: 0.041 grams (Approximate)
PDIP-8: 0.489 grams (Approximate)

IMPORTANT NOTICE

1. DIODES INCORPORATED (Diodes) AND ITS SUBSIDIARIES MAKE NO WARRANTY OF ANY KIND, EXPRESS OR IMPLIED, WITH REGARDS TO ANY INFORMATION CONTAINED IN THIS DOCUMENT, INCLUDING, BUT NOT LIMITED TO, THE IMPLIED WARRANTIES OF MERCHANTABILITY, FITNESS FOR A PARTICULAR PURPOSE OR NON-INFRINGEMENT OF THIRD PARTY INTELLECTUAL PROPERTY RIGHTS (AND THEIR EQUIVALENTS UNDER THE LAWS OF ANY JURISDICTION).
2. The Information contained herein is for informational purpose only and is provided only to illustrate the operation of Diodes' products described herein and application examples. Diodes does not assume any liability arising out of the application or use of this document or any product described herein. This document is intended for skilled and technically trained engineering customers and users who design with Diodes' products. Diodes' products may be used to facilitate safety-related applications; however, in all instances customers and users are responsible for (a) selecting the appropriate Diodes products for their applications, (b) evaluating the suitability of Diodes' products for their intended applications, (c) ensuring their applications, which incorporate Diodes' products, comply the applicable legal and regulatory requirements as well as safety and functional-safety related standards, and (d) ensuring they design with appropriate safeguards (including testing, validation, quality control techniques, redundancy, malfunction prevention, and appropriate treatment for aging degradation) to minimize the risks associated with their applications.
3. Diodes assumes no liability for any application-related information, support, assistance or feedback that may be provided by Diodes from time to time. Any customer or user of this document or products described herein will assume all risks and liabilities associated with such use, and will hold Diodes and all companies whose products are represented herein or on Diodes' websites, harmless against all damages and liabilities.
4. Products described herein may be covered by one or more United States, international or foreign patents and pending patent applications. Product names and markings noted herein may also be covered by one or more United States, international or foreign trademarks and trademark applications. Diodes does not convey any license under any of its intellectual property rights or the rights of any third parties (including third parties whose products and services may be described in this document or on Diodes' website) under this document.
5. Diodes' products are provided subject to Diodes' Standard Terms and Conditions of Sale (<https://www.diodes.com/about/company/terms-and-conditions/terms-and-conditions-of-sales/>) or other applicable terms. This document does not alter or expand the applicable warranties provided by Diodes. Diodes does not warrant or accept any liability whatsoever in respect of any products purchased through unauthorized sales channel.
6. Diodes' products and technology may not be used for or incorporated into any products or systems whose manufacture, use or sale is prohibited under any applicable laws and regulations. Should customers or users use Diodes' products in contravention of any applicable laws or regulations, or for any unintended or unauthorized application, customers and users will (a) be solely responsible for any damages, losses or penalties arising in connection therewith or as a result thereof, and (b) indemnify and hold Diodes and its representatives and agents harmless against any and all claims, damages, expenses, and attorney fees arising out of, directly or indirectly, any claim relating to any noncompliance with the applicable laws and regulations, as well as any unintended or unauthorized application.
7. While efforts have been made to ensure the information contained in this document is accurate, complete and current, it may contain technical inaccuracies, omissions and typographical errors. Diodes does not warrant that information contained in this document is error-free and Diodes is under no obligation to update or otherwise correct this information. Notwithstanding the foregoing, Diodes reserves the right to make modifications, enhancements, improvements, corrections or other changes without further notice to this document and any product described herein. This document is written in English but may be translated into multiple languages for reference. Only the English version of this document is the final and determinative format released by Diodes.
8. Any unauthorized copying, modification, distribution, transmission, display or other use of this document (or any portion hereof) is prohibited. Diodes assumes no responsibility for any losses incurred by the customers or users or any third parties arising from any such unauthorized use.
9. This Notice may be periodically updated with the most recent version available at <https://www.diodes.com/about/company/terms-and-conditions/important-notice>

The Diodes logo is a registered trademark of Diodes Incorporated in the United States and other countries.
All other trademarks are the property of their respective owners.
© 2024 Diodes Incorporated. All Rights Reserved.

www.diodes.com