

## Product Summary

Device	V <sub>RRM</sub> (V)	I <sub>o</sub> (A)	V <sub>F</sub> Max (V) @ +25°C	I <sub>R</sub> Max (mA) @ +25°C
B370BE/CE	70	3.0	0.79	0.10
B380BE/CE	80	3.0	0.79	0.15
B390BE/CE	90	3.0	0.79	0.20
B3100BE/CE	100	3.0	0.79	0.30

## Description and Applications

The Schottky rectifier providing low V<sub>F</sub> and excellent reverse leakage stability at high temperatures, this device is ideal for use in general rectification applications such as:

- Boost Diode
- Blocking Diode
- Recirculating Diode

## Features and Benefits

- Reduced Low Forward Voltage Drop (V<sub>F</sub>); Better Efficiency and Cooler Operation
- Reduced High-temperature Reverse Leakage; Increased Reliability against Thermal Runaway Failure in High Temperature Operation.
- **Lead-Free Finish; RoHS Compliant (Notes 1 & 2)**
- **Halogen and Antimony Free. "Green" Device (Note 3)**
- **For automotive applications requiring specific change control (i.e. parts qualified to AEC-Q100/101/200, PPAP capable, and manufactured in IATF 16949 certified facilities), please [contact us](#) or your local Diodes representative. <https://www.diodes.com/quality/product-definitions/>**

## Mechanical Data

- Case: SMB, SMC
- Case Material: Molded Plastic, "Green" Molding Compound. UL Flammability Classification Rating 94V-0
- Moisture Sensitivity: Level 1 per J-STD-020
- Terminals: Finish - Matte Tin Annealed over Copper Leadframe. Solderable per MIL-STD-202, Method 208 (E3)
- Polarity: Cathode Band
- Weight: SMB- 0.093 grams (Approximate)  
SMC- 0.21 grams (Approximate)

SMB, SMC

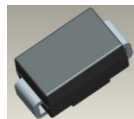

Top View

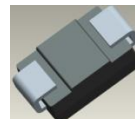

Bottom View

## Ordering Information (Notes 4 and 5)

Part Number	Case	Packaging	Status	Replacement
B370BE-13	SMB	3,000/Tape & Reel	NRND	<a href="#">B370B-13-F</a>
B370CE-13	SMC	3,000/Tape & Reel	NRND	<a href="#">B370-13-F</a>
B380BE-13	SMB	3,000/Tape & Reel	NRND	<a href="#">B380B-13-F</a>
B380CE-13	SMC	3,000/Tape & Reel	NRND	<a href="#">B380-13-F</a>
B390BE-13	SMB	3,000/Tape & Reel	NRND	<a href="#">B390B-13-F</a>
B390CE-13	SMC	3,000/Tape & Reel	NRND	<a href="#">B390-13-F</a>
B3100BE-13	SMB	3,000/Tape & Reel	Active	—
B3100CE-13	SMC	3,000/Tape & Reel	NRND	<a href="#">B3100-13-F</a>

- Notes:
1. EU Directive 2002/95/EC (RoHS), 2011/65/EU (RoHS 2) & 2015/863/EU (RoHS 3) compliant. All applicable RoHS exemptions applied.
  2. See <https://www.diodes.com/quality/lead-free/> for more information about Diodes Incorporated's definitions of Halogen- and Antimony-free, "Green" and Lead-free.
  3. Halogen- and Antimony-free "Green" products are defined as those which contain <900ppm bromine, <900ppm chlorine (<1500ppm total Br + Cl) and <1000ppm antimony compounds.
  4. For packaging details, go to our website at <https://www.diodes.com/design/support/packaging/diodes-packaging/>.
  5. NRND = Not recommended for new design.

## Marking Information

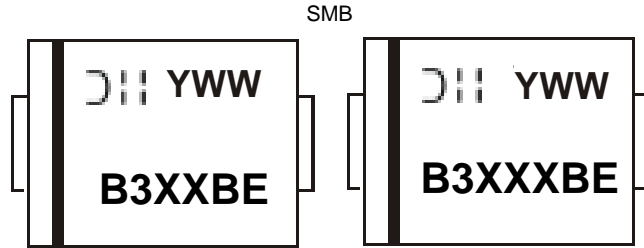

B3XXBE or B3XXXBE = Product Type Marking Code, ex: B370BE

DII = Manufacturers' Code Marking  
YWW = Date Code Marking  
Y = Last Digit of Year (ex: 0 for 2020)  
WW = Week Code (01 to 53)

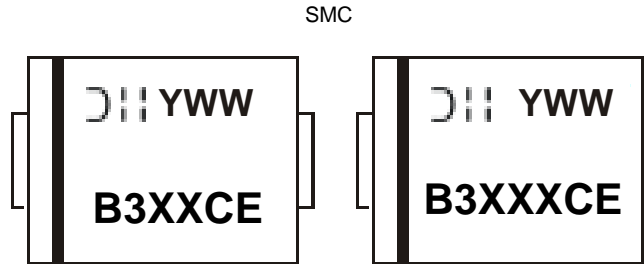

B3XXCE or B3XXXCE = Product Type Marking Code, ex: B370CE

DII = Manufacturers' Code Marking  
YWW = Date Code Marking  
Y = Last Digit of Year (ex: 0 for 2020)  
WW = Week Code (01 to 53)

## Maximum Ratings (@T<sub>A</sub> = +25°C, unless otherwise specified.)

Single phase, half wave, 60Hz, resistive or inductive load.  
For capacitive load, derate current by 20%.

Characteristic	Symbol	B370BE B370CE	B380BE B380CE	B390BE B390CE	B3100BE B3100CE	Unit
Peak Repetitive Reverse Voltage	V <sub>RRM</sub>	70	80	90	100	V
Working Peak Reverse Voltage	V <sub>RWM</sub>					
DC Blocking Voltage	V <sub>RM</sub>					
Average Rectified Output Current	I <sub>o</sub>	3				A
Non-Repetitive Peak Forward Surge Current 8.3ms Single Half Sine-Wave Superimposed on Rated Load	I <sub>FSM</sub>	100				A

## Thermal Characteristics

Characteristic	Symbol	Value	Unit
Typical Thermal Resistance Junction to Ambient (Note 6)	SMB	90	°C/W
	SMC	70	
Typical Thermal Resistance Junction to Case (Note 6)	SMB	50	°C/W
	SMC	30	
Operating and Storage Temperature Range	T <sub>J</sub> , T <sub>STG</sub>	-55 to +150	°C

## Electrical Characteristics (@T<sub>A</sub> = +25°C, unless otherwise specified.)

Characteristic	Symbol	Min	Typ	Max	Unit	Test Condition
Forward Voltage Drop	V <sub>F</sub>	—	0.74 0.60	0.79 —	V	I <sub>F</sub> = 3A, T <sub>A</sub> = +25°C I <sub>F</sub> = 3A, T <sub>A</sub> = +125°C
Leakage Current (Note 7)	I <sub>R</sub>	—	—	0.10	mA	V <sub>R</sub> = 70V, T <sub>A</sub> = +25°C
				0.15		V <sub>R</sub> = 80V, T <sub>A</sub> = +25°C
				0.20		V <sub>R</sub> = 90V, T <sub>A</sub> = +25°C
				0.30		V <sub>R</sub> = 100V, T <sub>A</sub> = +25°C
				—		V <sub>R</sub> = 100V, T <sub>A</sub> = +125°C
Typical Capacitance	C <sub>T</sub>	—	105	—	pF	V <sub>R</sub> = 4.0V, f = 1MHz

Notes: 6. Device mounted on FR-4 substrate, 1"\*1", 2oz, single-sided, PC boards with 0.56"\*0.73" copper pad.  
7. Short duration pulse test used to minimize self-heating effect.

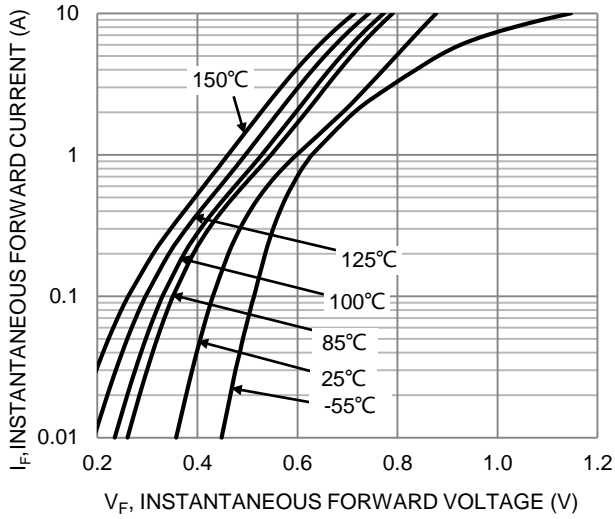

Figure 1. Typical Forward Characteristics

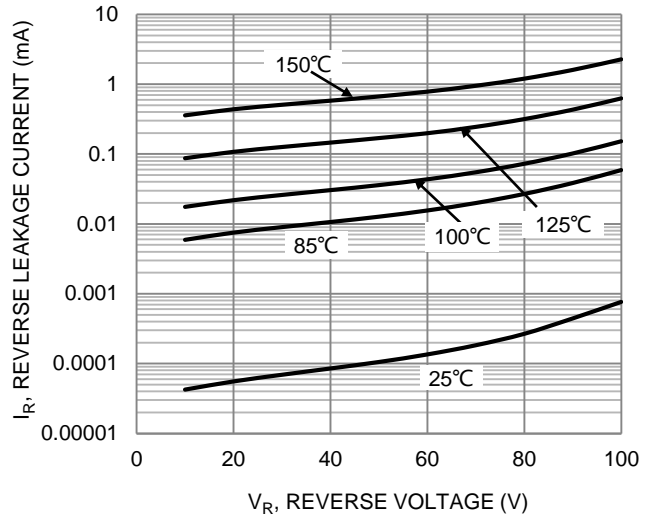

Figure 2. Typical Reverse Characteristics

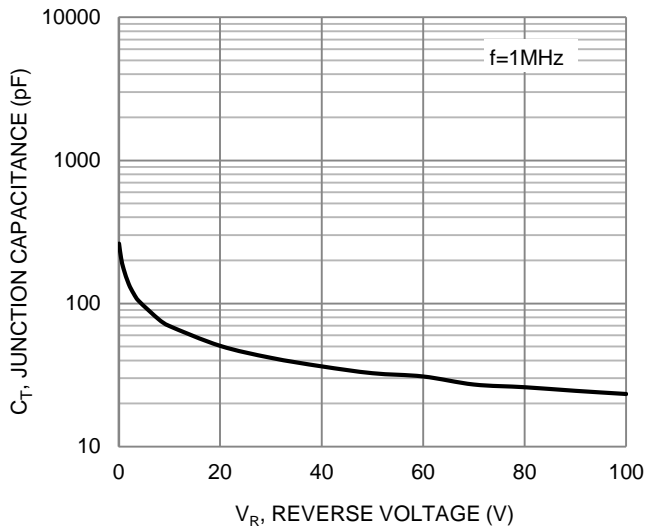

Figure 3. Typical Junction Capacitance

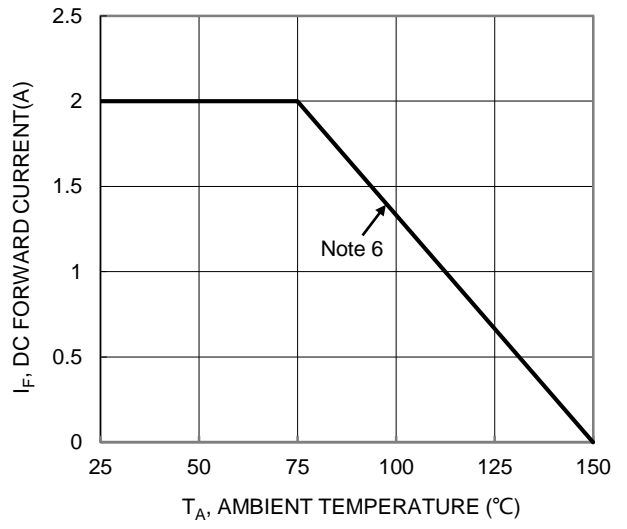
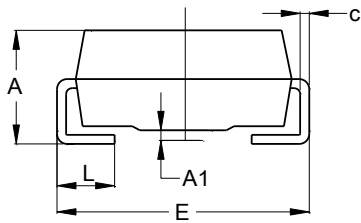
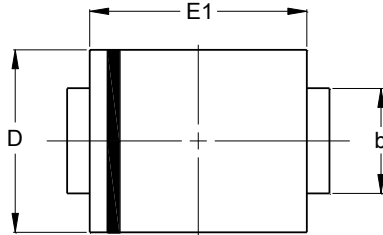

Figure 4. DC Forward Current Derating

**Package Outline Dimensions**

Please see <http://www.diodes.com/package-outlines.html> for the latest version.

**SMB**



SMB		
Dim	Min	Max
A	2.00	2.50
A1	0.05	0.20
b	1.96	2.21
c	0.15	0.31
D	3.30	3.94
E	5.00	5.59
E1	4.06	4.57
L	0.76	1.52
All Dimensions in mm		

**SMC**

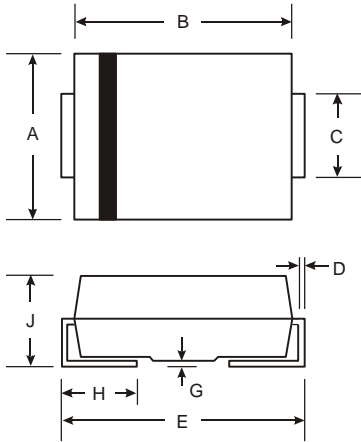

SMC		
Dim	Min	Max
A	5.59	6.22
B	6.60	7.11
C	2.75	3.18
D	0.15	0.31
E	7.75	8.13
G	0.10	0.20
H	0.76	1.52
J	2.00	2.50
All Dimensions in mm		

## Suggested Pad Layout

Please see <http://www.diodes.com/package-outlines.html> for the latest version.

### SMB

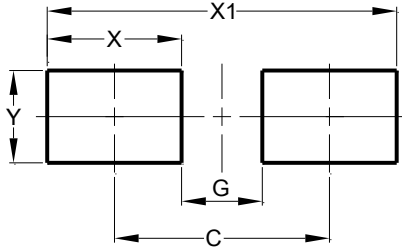

Dimensions	Value (in mm)
<b>C</b>	4.30
<b>G</b>	1.80
<b>X</b>	2.50
<b>X1</b>	6.80
<b>Y</b>	2.30

### SMC

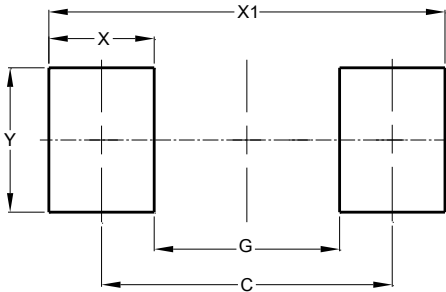

Dimensions	Value (in mm)
<b>C</b>	6.90
<b>G</b>	4.40
<b>X</b>	2.50
<b>X1</b>	9.40
<b>Y</b>	3.30

### IMPORTANT NOTICE

DIODES INCORPORATED MAKES NO WARRANTY OF ANY KIND, EXPRESS OR IMPLIED, WITH REGARDS TO THIS DOCUMENT, INCLUDING, BUT NOT LIMITED TO, THE IMPLIED WARRANTIES OF MERCHANTABILITY AND FITNESS FOR A PARTICULAR PURPOSE (AND THEIR EQUIVALENTS UNDER THE LAWS OF ANY JURISDICTION).

Diodes Incorporated and its subsidiaries reserve the right to make modifications, enhancements, improvements, corrections or other changes without further notice to this document and any product described herein. Diodes Incorporated does not assume any liability arising out of the application or use of this document or any product described herein; neither does Diodes Incorporated convey any license under its patent or trademark rights, nor the rights of others. Any Customer or user of this document or products described herein in such applications shall assume all risks of such use and will agree to hold Diodes Incorporated and all the companies whose products are represented on Diodes Incorporated website, harmless against all damages.

Diodes Incorporated does not warrant or accept any liability whatsoever in respect of any products purchased through unauthorized sales channel. Should Customers purchase or use Diodes Incorporated products for any unintended or unauthorized application, Customers shall indemnify and hold Diodes Incorporated and its representatives harmless against all claims, damages, expenses, and attorney fees arising out of, directly or indirectly, any claim of personal injury or death associated with such unintended or unauthorized application.

Products described herein may be covered by one or more United States, international or foreign patents pending. Product names and markings noted herein may also be covered by one or more United States, international or foreign trademarks.

This document is written in English but may be translated into multiple languages for reference. Only the English version of this document is the final and determinative format released by Diodes Incorporated.

### LIFE SUPPORT

Diodes Incorporated products are specifically not authorized for use as critical components in life support devices or systems without the express written approval of the Chief Executive Officer of Diodes Incorporated. As used herein:

A. Life support devices or systems are devices or systems which:

1. are intended to implant into the body, or
2. support or sustain life and whose failure to perform when properly used in accordance with instructions for use provided in the labeling can be reasonably expected to result in significant injury to the user.

B. A critical component is any component in a life support device or system whose failure to perform can be reasonably expected to cause the failure of the life support device or to affect its safety or effectiveness.

Customers represent that they have all necessary expertise in the safety and regulatory ramifications of their life support devices or systems, and acknowledge and agree that they are solely responsible for all legal, regulatory and safety-related requirements concerning their products and any use of Diodes Incorporated products in such safety-critical, life support devices or systems, notwithstanding any devices- or systems-related information or support that may be provided by Diodes Incorporated. Further, Customers must fully indemnify Diodes Incorporated and its representatives against any damages arising out of the use of Diodes Incorporated products in such safety-critical, life support devices or systems.

Copyright © 2020, Diodes Incorporated

[www.diodes.com](http://www.diodes.com)