

Features

- Fast Switching Speed: max. 50 ns
- High Reverse Breakdown Voltage: 300V
- Low Leakage Current: 100nA at room temperature
- Ultra Small Plastic SMD Package
- **Totally Lead-Free & Fully RoHS Compliant (Notes 1 & 2)**
- **Halogen and Antimony Free. "Green" Device (Note 3)**
- **Qualified to AEC-Q101 Standards for High Reliability**
- **PPAP Capable (Note 5)**

Mechanical Data

- Case: SOD-523
- Case Material: Molded Plastic, "Green" Molding Compound. UL Flammability Classification Rating 94V-0
- Moisture Sensitivity: Level 1 per J-STD-020
- Terminal Connections: Cathode Bar
- Terminals: Finish - Matte Tin Annealed over Alloy 42 Leadframe.
- Solderable per MIL-STD-202, Method 208 ③
- Weight: 0.0014 grams (Approximate)

SOD523



Top View



Device Schematic

Ordering Information (Note 4)

Part Number	Compliance	Case	Packaging (Note 6)
BAS521Q-13	Automotive	SOD523	10,000/Tape & Reel

- Notes:
1. No purposely added lead. Fully EU Directive 2002/95/EC (RoHS) & 2011/65/EU (RoHS 2) compliant.
 2. See <https://www.diodes.com/quality/lead-free/> for more information about Diodes Incorporated's definitions of Halogen- and Antimony-free, "Green" and Lead-free.
 3. Halogen- and Antimony-free "Green" products are defined as those which contain <900ppm bromine, <900ppm chlorine (<1500ppm total Br + Cl) and <1000ppm antimony compounds.
 4. For packaging details, go to our website at <http://www.diodes.com/products/packages.html>.
 5. Automotive products are AEC-Q101 qualified and are PPAP capable. Refer to http://www.diodes.com/quality/product_compliance_definitions/.
 6. Dispensed in every other cavity of the tape.

Marking Information

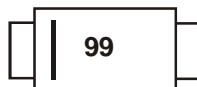

99 = Product Type Marking Code
Bar Denotes Cathode Side

Maximum Ratings (@ $T_A = +25^\circ\text{C}$, unless otherwise specified.)

Characteristic	Symbol	Value	Unit
Repetitive Peak Reverse Voltage	V_{RRM}	300	V
Working Peak Reverse Voltage	V_{RWM}	300	V
DC Blocking Voltage			
Forward Current (Note 7)	I_F	250	mA
Non-Repetitive Peak Forward Surge Current @ $t = 1.0\mu\text{s}$	I_{FSM}	4.5	A
Repetitive Peak Forward Current (Note 7)	I_{FRM}	1	A

Thermal Characteristics

Characteristic	Symbol	Value	Unit
Power Dissipation (Note 7)	P_D	325	mW
Thermal Resistance Junction to Ambient Air (Note 7)	$R_{\theta JA}$	385	$^\circ\text{C/W}$
Operating and Storage Temperature Range	T_J, T_{STG}	-65 to +150	$^\circ\text{C}$

Electrical Characteristics (@ $T_A = +25^\circ\text{C}$, unless otherwise specified.)

Characteristic	Symbol	Min	Max	Unit	Test Condition
Reverse Breakdown Voltage (Note 8)	$V_{(BR)R}$	300	—	V	$I_R = 100\mu\text{A}$
Forward Voltage	V_F	—	1.1	V	$I_F = 100\text{mA}$
Reverse Current (Note 8)	I_R	—	50	nA	$V_R = 5\text{V}$
		—	150	nA	$V_R = 250\text{V}$
		—	100	μA	$V_R = 250\text{V}, T_J = +150^\circ\text{C}$
Total Capacitance	C_T	—	5	pF	$V_R = 0, f = 1.0\text{MHz}$
Reverse Recovery Time	t_{rr}	—	50	ns	$I_F = I_R = 30\text{mA}, I_{rr} = 0.1 \times I_R, R_L = 100\Omega$

Notes: 7. Part mounted on FR-4 board with recommended pad layout, which can be found on our website at <http://www.diodes.com>.
8. Short duration pulse test used to minimize self-heating effect.

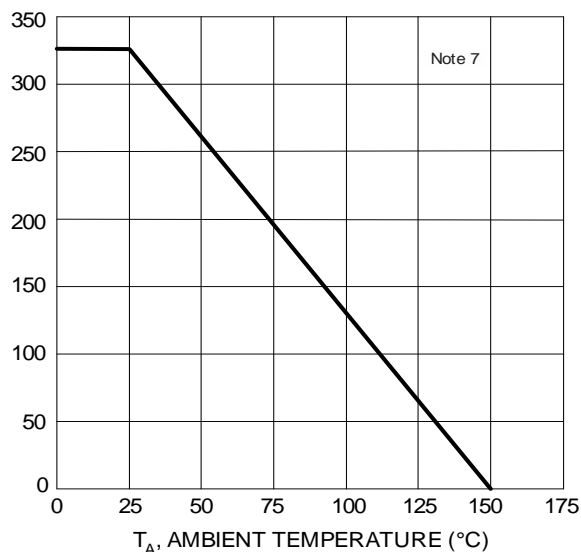

Figure 1 Power Derating Curve, Total Package

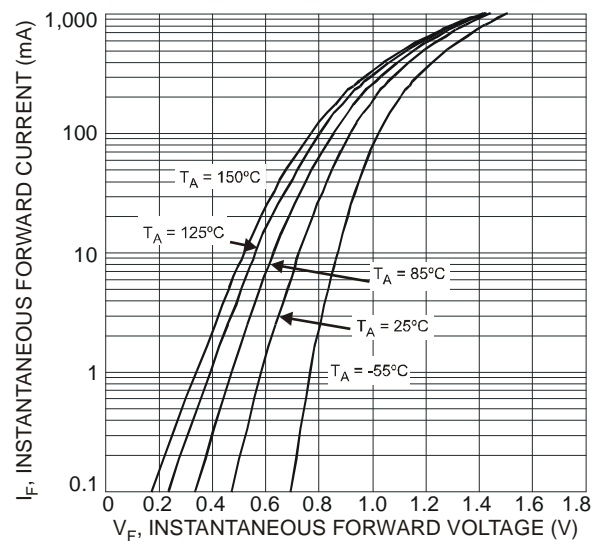

Fig. 2 Typical Forward Characteristics, Per Element

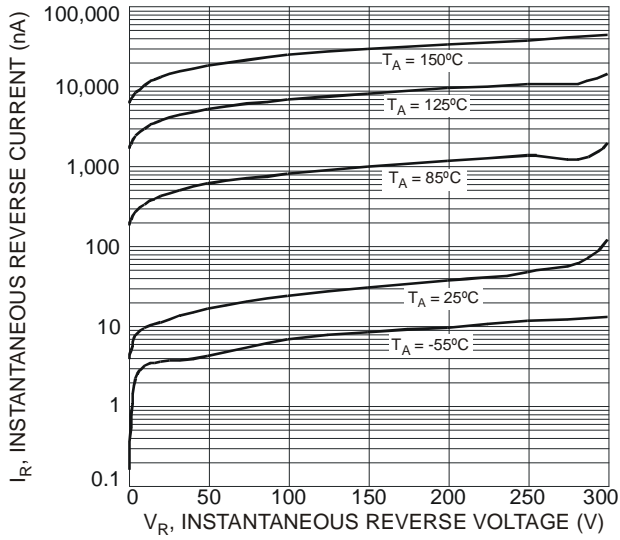

Fig. 3 Typical Reverse Characteristics, Per Element

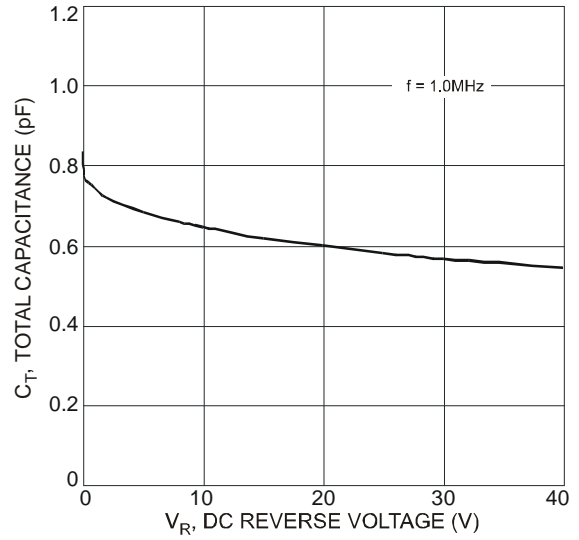
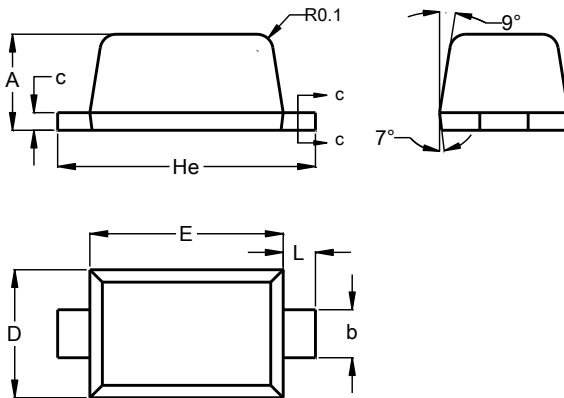

Fig. 4 Total Capacitance vs. Reverse Voltage, Per Element

Package Outline Dimensions

Please see <http://www.diodes.com/package-outlines.html> for the latest version.



SOD523		
Dim	Min	Max
A	0.55	0.65
b	0.26	0.34
c	0.11	0.17
D	0.75	0.85
E	1.15	1.25
He	1.55	1.65
L	0.10	0.30
All Dimensions in mm		

Suggested Pad Layout

Please see <http://www.diodes.com/package-outlines.html> for the latest version.

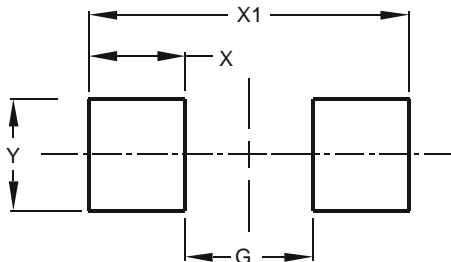

Dimensions	Value (in mm)
G	0.80
X	0.60
X1	2.00
Y	0.70

IMPORTANT NOTICE

DIODES INCORPORATED MAKES NO WARRANTY OF ANY KIND, EXPRESS OR IMPLIED, WITH REGARDS TO THIS DOCUMENT, INCLUDING, BUT NOT LIMITED TO, THE IMPLIED WARRANTIES OF MERCHANTABILITY AND FITNESS FOR A PARTICULAR PURPOSE (AND THEIR EQUIVALENTS UNDER THE LAWS OF ANY JURISDICTION).

Diodes Incorporated and its subsidiaries reserve the right to make modifications, enhancements, improvements, corrections or other changes without further notice to this document and any product described herein. Diodes Incorporated does not assume any liability arising out of the application or use of this document or any product described herein; neither does Diodes Incorporated convey any license under its patent or trademark rights, nor the rights of others. Any Customer or user of this document or products described herein in such applications shall assume all risks of such use and will agree to hold Diodes Incorporated and all the companies whose products are represented on Diodes Incorporated website, harmless against all damages.

Diodes Incorporated does not warrant or accept any liability whatsoever in respect of any products purchased through unauthorized sales channel. Should Customers purchase or use Diodes Incorporated products for any unintended or unauthorized application, Customers shall indemnify and hold Diodes Incorporated and its representatives harmless against all claims, damages, expenses, and attorney fees arising out of, directly or indirectly, any claim of personal injury or death associated with such unintended or unauthorized application.

Products described herein may be covered by one or more United States, international or foreign patents pending. Product names and markings noted herein may also be covered by one or more United States, international or foreign trademarks.

This document is written in English but may be translated into multiple languages for reference. Only the English version of this document is the final and determinative format released by Diodes Incorporated.

LIFE SUPPORT

Diodes Incorporated products are specifically not authorized for use as critical components in life support devices or systems without the express written approval of the Chief Executive Officer of Diodes Incorporated. As used herein:

A. Life support devices or systems are devices or systems which:

1. are intended to implant into the body, or
2. support or sustain life and whose failure to perform when properly used in accordance with instructions for use provided in the labeling can be reasonably expected to result in significant injury to the user.

B. A critical component is any component in a life support device or system whose failure to perform can be reasonably expected to cause the failure of the life support device or to affect its safety or effectiveness.

Customers represent that they have all necessary expertise in the safety and regulatory ramifications of their life support devices or systems, and acknowledge and agree that they are solely responsible for all legal, regulatory and safety-related requirements concerning their products and any use of Diodes Incorporated products in such safety-critical, life support devices or systems, notwithstanding any devices- or systems-related information or support that may be provided by Diodes Incorporated. Further, Customers must fully indemnify Diodes Incorporated and its representatives against any damages arising out of the use of Diodes Incorporated products in such safety-critical, life support devices or systems.

Copyright © 2017, Diodes Incorporated

www.diodes.com