

Product Summary

- Continuous Drain-Source Voltage: $V_{DS} = 60V$
- On-State Resistance: $500m\Omega$
- Max Nominal Load Current ($V_{IN} = 5V$): 1.1A
- Min Nominal Load Current ($V_{IN} = 5V$): 0.7A
- Clamping Energy: 550mJ

Description

The BSP75N-13 is a self-protected, low-side IntelliFET[®] MOSFET. It features monolithic overtemperature, overcurrent, overvoltage (active clamp), and ESD protected logic-level functionality. It is intended as a general-purpose switch.

Applications

- Especially suited for loads with high inrush current, such as lamps and motors
- All types of resistive, inductive, and capacitive loads in switching applications
- μC compatible power switches for 12V and 24V DC applications
- Replaces electromechanical relays and discrete circuits
- Linear mode capabilities—current-limiting protection circuitry is designed to deactivate at low V_{DS} to not compromise the load current during normal operation. Maximum DC operating current is therefore determined by thermal capability of the package/board combination rather than by protection circuitry, which does not compromise the product's ability to self-protect at low V_{DS} .

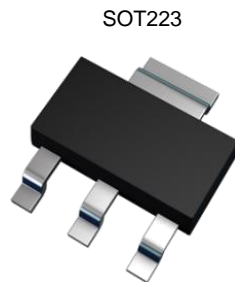

Top View

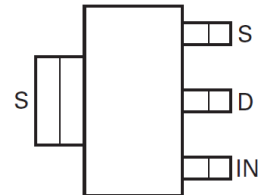

Top View
Pin Out

Features and Benefits

- Short-Circuit Protection with Auto Restart
- Overvoltage Protection (Active Clamp)
- Thermal Shutdown with Auto Restart
- Overcurrent Protection
- Input Protection (ESD)
- Load-Dump Protection (Actively Protects Load)
- Logic-Level Input
- High Continuous Current Rating
- **Lead-Free Finish; RoHS Compliant (Note 1 & 2)**
- **Halogen and Antimony Free. "Green" Device (Note 3)**
- **For automotive applications requiring specific change control (i.e. parts qualified to AEC-Q100/101/104/200, PPAP capable, and manufactured in IATF 16949 certified facilities), please [contact us](mailto:contact@diodes.com) or your local Diodes representative. <https://www.diodes.com/quality/product-definitions/>**

Mechanical Data

- Package: SOT223
- Package Material: Molded Plastic, "Green" Molding Compound
UL Flammability Classification Rating 94V-0
- Moisture Sensitivity: Level 1 per J-STD-020
- Terminals: Matte Tin Finish e3
- Weight: 0.112 grams (Approximate)

Ordering Information (Note 4)

Part Number	Package	Marking	Reel Size (inches)	Tape Width (mm)	Packing	
					Qty.	Carrier
BSP75N-13	SOT223	BSP75N	13	12	4,000 Units	Reel

- Notes:
1. EU Directive 2002/95/EC (RoHS), 2011/65/EU (RoHS 2) & 2015/863/EU (RoHS 3) compliant. All applicable RoHS exemptions applied.
 2. See <https://www.diodes.com/quality/lead-free/> for more information about Diodes Incorporated's definitions of Halogen- and Antimony-free, "Green" and Lead-free.
 3. Halogen- and Antimony-free "Green" products are defined as those which contain <900ppm bromine, <900ppm chlorine (<1500ppm total Br + Cl) and <1000ppm antimony compounds.
 4. For packaging details, go to our website at <https://www.diodes.com/design/support/packaging/diodes-packaging/>.

Marking Information

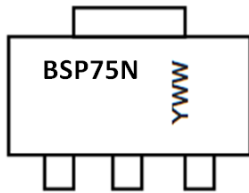

BSP75N = Product Type Marking Code
 YWW = Date Code Marking
 Y or Ȳ = Last Digit of Year (ex: 4 = 2024)
 WW or WW = Week Code (01 to 53)

Functional Block Diagram

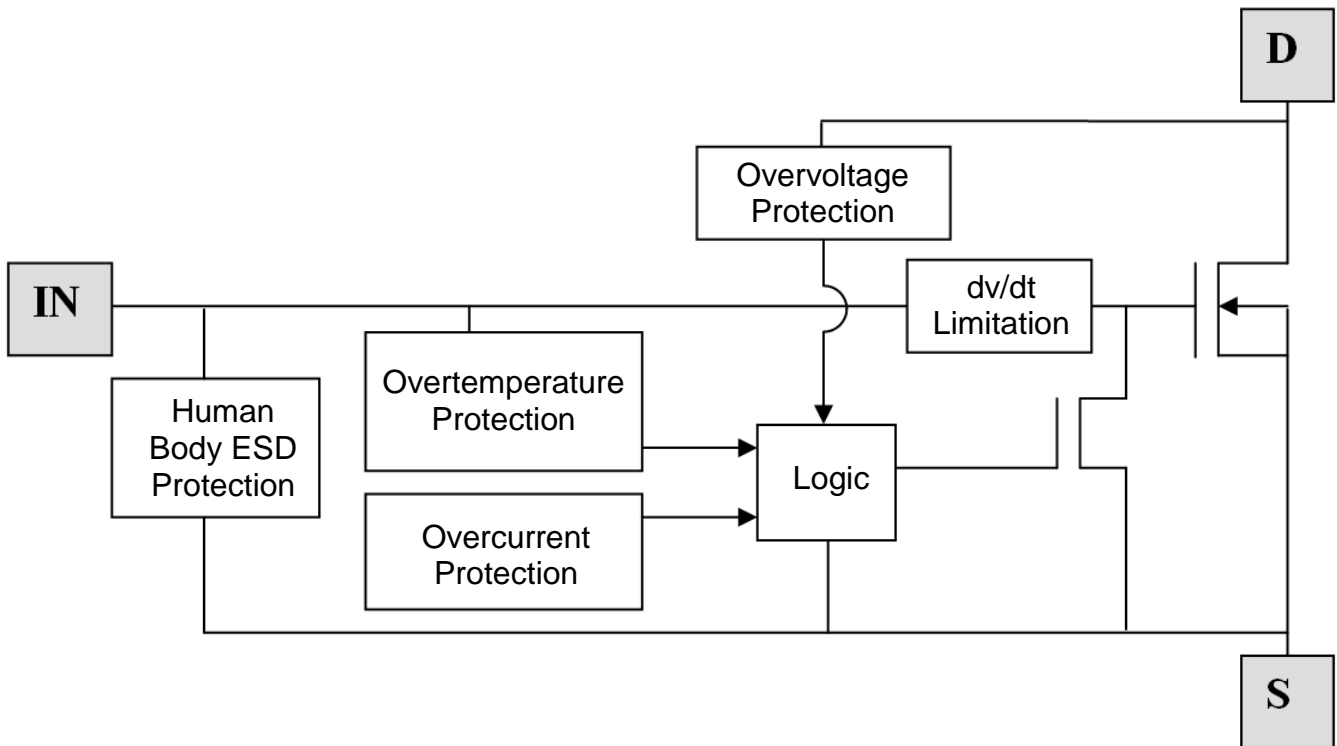

Absolute Maximum Ratings (@T_A = +25°C, unless otherwise specified.)

Parameter	Symbol	Value	Unit
Continuous Drain-Source Voltage	V _{DS}	60	V
Drain-Source Voltage for Short-Circuit Protection, V _{IN} = 5V	V _{DS(SC)}	36	V
Drain-Source Voltage for Short-Circuit Protection, V _{IN} = 10V	V _{DS(SC)}	20	V
Continuous Input Voltage	V _{IN}	-0.2 to 10	V
Peak Input Voltage	V _{IN}	-0.2 to 20	V
Operating Temperature Range	T _J	-40 to +150	°C
Storage Temperature Range	T _{STG}	-55 to +150	°C
Power Dissipation at T _A = +25°C (Note 5)	P _D	1.5	W
Power Dissipation at T _A = +25°C (Note 6)	P _D	0.6	W
Continuous Drain Current @ V _{IN} = 10V, T _A = +25°C (Note 5)	I _D	1.3	A
Continuous Drain Current @ V _{IN} = 5V, T _A = +25°C (Note 5)	I _D	1.1	A
Continuous Drain Current @ V _{IN} = 5V, T _A = +25°C (Note 6)	I _D	0.7	A
Continuous Source Current (Body Diode) (Note 5)	I _S	2.0	A
Pulsed Source Current (Body Diode) (Note 7)	I _S	3.3	A
Unclamped Single Pulse Inductive Energy	E _{AS}	550	mJ
Load Dump Protection	V _{LOAD_DUMP}	80	V
Electrostatic Discharge (Human Body Model)	V _{ESD}	4000	V
DIN Humidity Category, DIN 40 040	—	E	—
IEC Climatic Category, DIN IEC 68-1	—	40/150/56	—

Thermal Resistance

Parameter	Symbol	Value	Unit
Junction to Ambient (Note 5)	R _{θJA}	83	°C/W
Junction to Ambient (Note 7)	R _{θJA}	45	°C/W
Junction to Ambient (Note 6)	R _{θJA}	208	°C/W

- Notes:
5. For a device surface-mounted on 25mm x 25mm x 1.6mm FR-4 board with a high coverage of single-sided 2oz weight copper. Allocation of 6cm² copper 33% to source tab and 66% to drain pin with source tab and drain pin electrically isolated.
 6. For a device surface-mounted on FR-4 board with the minimum copper required for electrical connections.
 7. For a device surface-mounted on FR-4 board as (a) and measured at t ≤ 10s.

Electrical Characteristics (@T_A = +25°C, unless otherwise specified.)

Characteristic	Symbol	Min	Typ	Max	Unit	Conditions
Static Characteristics						
Drain-Source Clamp Voltage	V _{DS(AZ)}	60	70	75	V	I _D = 10mA
Off-State Drain Current	I _{DSS}	—	0.1	3	μA	V _{DS} = 12V, V _{IN} = 0V
Off-State Drain Current	I _{DSS}	—	3	15	μA	V _{DS} = 32V, V _{IN} = 0V
Input Threshold Voltage (Note 8)	V _{IN(TH)}	1	2.1	—	V	V _{DS} = V _{GS} , I _D = 1mA
Input Current	I _{IN}	—	0.7	1.2	mA	V _{IN} = 5V
Input Current	I _{IN}	—	1.5	2.7	mA	V _{IN} = 7V
Input Current	I _{IN}	—	4	7	mA	V _{IN} = 10V
Static Drain-Source On-State Resistance	R _{DS(ON)}	—	520	675	mΩ	V _{IN} = 5V, I _D = 0.7A
Static Drain-Source On-State Resistance	R _{DS(ON)}	—	385	550	mΩ	V _{IN} = 10V, I _D = 0.7A
Current Limit (Note 9)	I _{D(LIM)}	0.7	1.0	1.5	A	V _{IN} = 5V, V _{DS} > 5V
Current Limit (Note 9)	I _{D(LIM)}	1	1.8	2.3	A	V _{IN} = 10V, V _{DS} > 5V
Dynamic Characteristics						
Turn-On Time (V _{IN} to 90% I _D)	t _{ON}	—	3	—	μs	R _L = 22Ω, V _{IN} = 0V to 10V V _{DD} = 12V
Turn-Off Time (V _{IN} to 90% I _D)	t _{OFF}	—	13	—	μs	R _L = 22Ω, V _{IN} = 10V to 0V V _{DD} = 12V
Slew Rate On (70% to 50% V _{DD})	-dv _{DS} /dt _{ON}	—	8	—	V/μs	R _L = 22Ω, V _{IN} = 0V to 10V V _{DD} = 12V
Slew Rate Off (50% to 70% V _{DD})	dv _{DS} /dt _{ON}	—	3.2	—	V/μs	R _L = 22Ω, V _{IN} = 10V to 0V V _{DD} = 12V
Protection Functions (Note 10)						
Minimum Input Voltage for Overtemperature Protection	V _{PROT}	4.5	—	—	V	—
Thermal Overload Trip Temperature	T _{JT}	+150	+175	—	°C	—
Thermal Hysteresis	—	—	+1	—	°C	—
Unclamped Single Pulse Inductive Energy T _J = +25°C	E _{AS}	550	—	—	mJ	I _{D(ISO)} = 0.7A, V _{DD} = 32V
Unclamped Single Pulse Inductive Energy T _J = +150°C	E _{AS}	200	—	—	mJ	I _{D(ISO)} = 0.7A, V _{DD} = 32V
Inverse Diode						
Source-Drain Voltage	V _{SD}	—	—	1	V	V _{IN} = 0V, -I _D = 1.4A

- Notes:
8. Protection features may operate outside spec for V_{IN} < 4.5V.
 9. The drain current is limited to a reduced value when V_{DS} exceeds a safe level.
 10. Integrated protection functions are designed to prevent IC destruction under fault conditions described in the datasheet. Fault conditions are considered as "outside" normal operating range. Protection functions are not designed for continuous, repetitive operation.

Application Information

The current-limit protection circuitry is designed to deactivate at low V_{DS} to prevent the load current from being unnecessarily restricted during normal operation. The design max DC operating current is therefore determined by the thermal capability of the package/board combination rather than by the protection circuitry (see *Typical Characteristics* graphs). This does not compromise the products ability to self-protect at low V_{DS} .

The overtemperature protection circuit trips at a minimum of +150°C, so the available package dissipation reduces as the maximum required ambient temperature increases. This leads to the following maximum recommended continuous operating currents.

Minimum Copper Area Characteristics

For minimum copper condition as described in Note 6.

Max Ambient Temperature T_A	Maximum Continuous Current	
	$V_{IN} = 5V$	$V_{IN} = 10V$
+25°C	720mA	840mA
+70°C	575mA	670mA
+85°C	520mA	605mA
+125°C	320mA	375mA

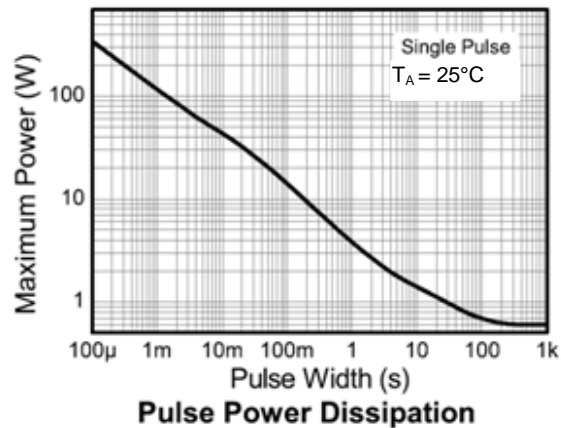
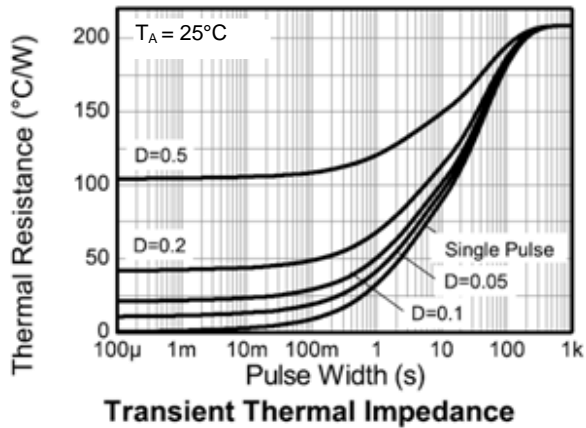
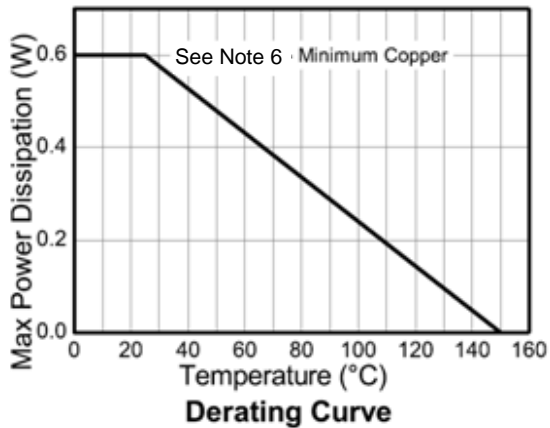
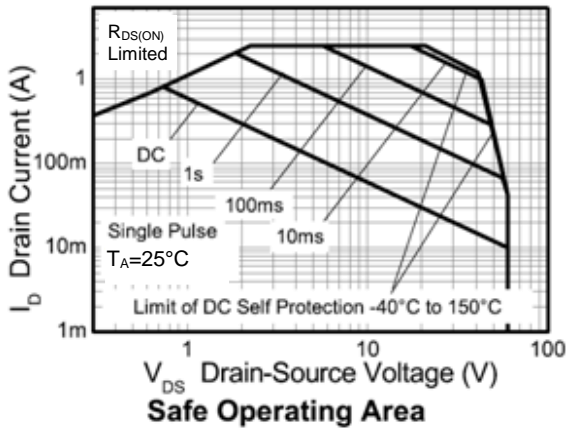

Large Copper Area Characteristics

For large copper area as described in Note 5.

Max Ambient Temperature T_A	Maximum Continuous Current	
	$V_{IN} = 5V$	$V_{IN} = 10V$
+25°C	1140mA	1325mA
+70°C	915mA	1060mA
+85°C	825mA	955mA
+125°C	510mA	590mA

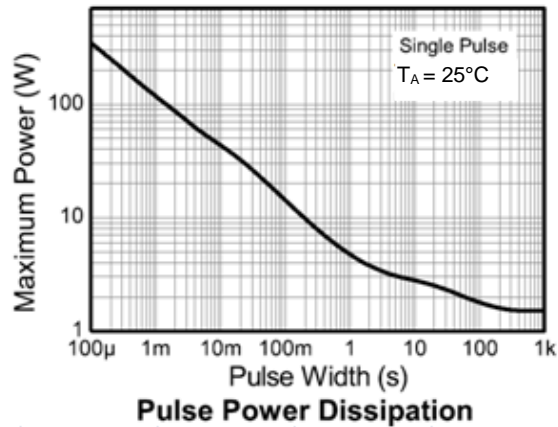
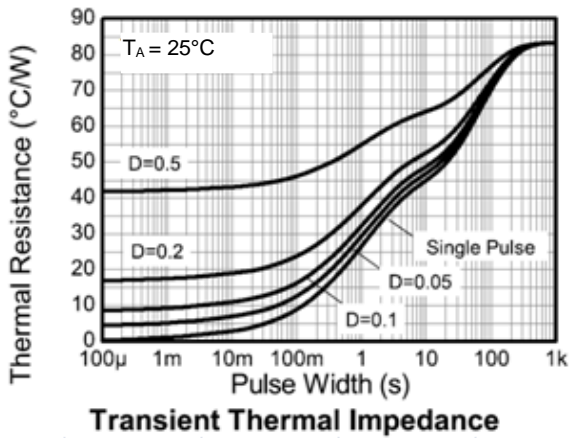
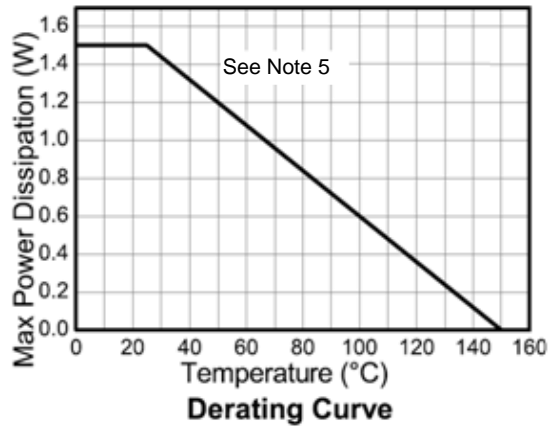
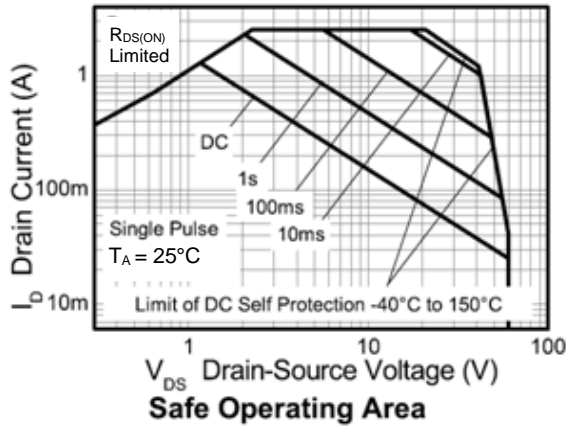

Typical Characteristics

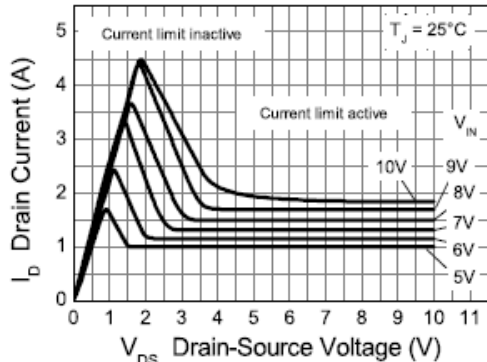

Typical Output Characteristic

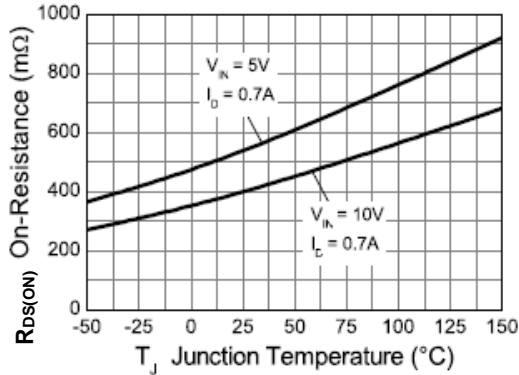

On-State Resistance vs Temperature

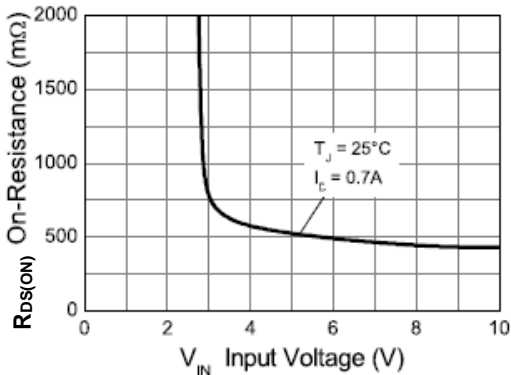

On-Resistance vs Input Voltage

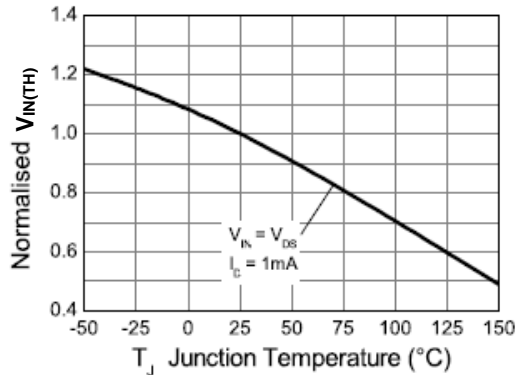

Threshold Voltage vs Temperature

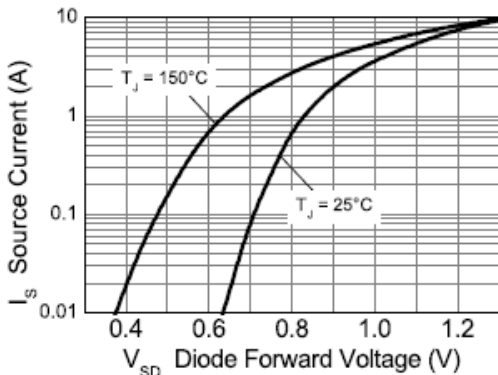

Source-Drain Diode Forward Voltage

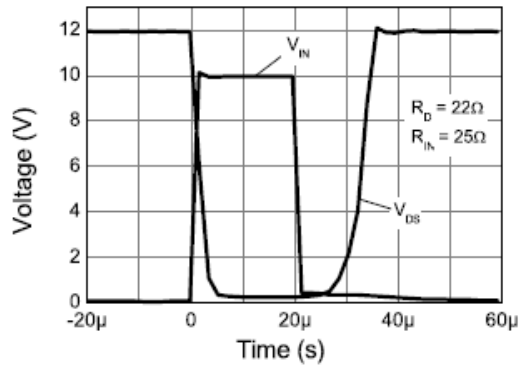

Switching Speed

Package Outline Dimensions

Please see <http://www.diodes.com/package-outlines.html> for the latest version.

SOT223

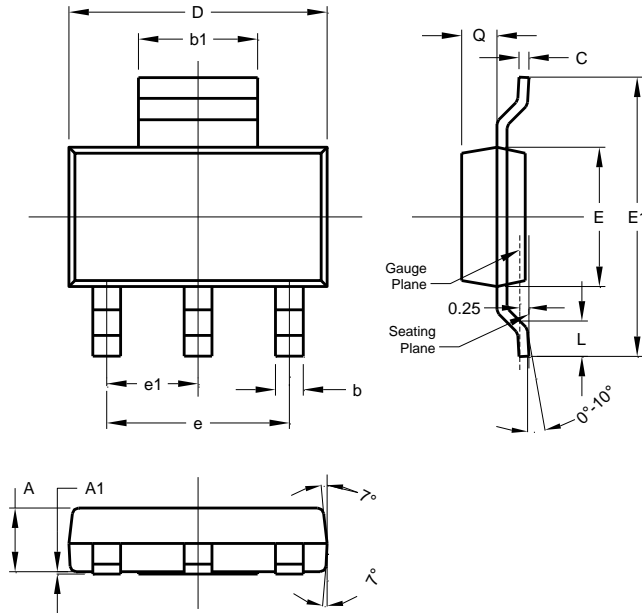

SOT223			
Dim	Min	Max	Typ
A	1.55	1.65	1.60
A1	0.010	0.15	0.05
b	0.60	0.80	0.70
b1	2.90	3.10	3.00
C	0.20	0.30	0.25
D	6.45	6.55	6.50
E	3.45	3.55	3.50
E1	6.90	7.10	7.00
e	-	-	4.60
e1	-	-	2.30
L	0.85	1.05	0.95
Q	0.84	0.94	0.89
All Dimensions in mm			

Suggested Pad Layout

Please see <http://www.diodes.com/package-outlines.html> for the latest version.

SOT223

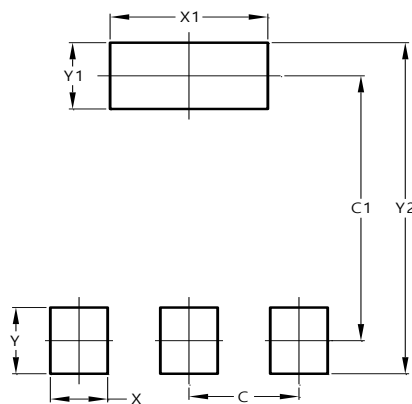

Dimensions	Value (in mm)
C	2.30
C1	6.40
X	1.20
X1	3.30
Y	1.60
Y1	1.60
Y2	8.00

IMPORTANT NOTICE

1. DIODES INCORPORATED (Diodes) AND ITS SUBSIDIARIES MAKE NO WARRANTY OF ANY KIND, EXPRESS OR IMPLIED, WITH REGARDS TO ANY INFORMATION CONTAINED IN THIS DOCUMENT, INCLUDING, BUT NOT LIMITED TO, THE IMPLIED WARRANTIES OF MERCHANTABILITY, FITNESS FOR A PARTICULAR PURPOSE OR NON-INFRINGEMENT OF THIRD PARTY INTELLECTUAL PROPERTY RIGHTS (AND THEIR EQUIVALENTS UNDER THE LAWS OF ANY JURISDICTION).
2. The Information contained herein is for informational purpose only and is provided only to illustrate the operation of Diodes' products described herein and application examples. Diodes does not assume any liability arising out of the application or use of this document or any product described herein. This document is intended for skilled and technically trained engineering customers and users who design with Diodes' products. Diodes' products may be used to facilitate safety-related applications; however, in all instances customers and users are responsible for (a) selecting the appropriate Diodes products for their applications, (b) evaluating the suitability of Diodes' products for their intended applications, (c) ensuring their applications, which incorporate Diodes' products, comply the applicable legal and regulatory requirements as well as safety and functional-safety related standards, and (d) ensuring they design with appropriate safeguards (including testing, validation, quality control techniques, redundancy, malfunction prevention, and appropriate treatment for aging degradation) to minimize the risks associated with their applications.
3. Diodes assumes no liability for any application-related information, support, assistance or feedback that may be provided by Diodes from time to time. Any customer or user of this document or products described herein will assume all risks and liabilities associated with such use, and will hold Diodes and all companies whose products are represented herein or on Diodes' websites, harmless against all damages and liabilities.
4. Products described herein may be covered by one or more United States, international or foreign patents and pending patent applications. Product names and markings noted herein may also be covered by one or more United States, international or foreign trademarks and trademark applications. Diodes does not convey any license under any of its intellectual property rights or the rights of any third parties (including third parties whose products and services may be described in this document or on Diodes' website) under this document.
5. Diodes' products are provided subject to Diodes' Standard Terms and Conditions of Sale (<https://www.diodes.com/about/company/terms-and-conditions/terms-and-conditions-of-sales/>) or other applicable terms. This document does not alter or expand the applicable warranties provided by Diodes. Diodes does not warrant or accept any liability whatsoever in respect of any products purchased through unauthorized sales channel.
6. Diodes' products and technology may not be used for or incorporated into any products or systems whose manufacture, use or sale is prohibited under any applicable laws and regulations. Should customers or users use Diodes' products in contravention of any applicable laws or regulations, or for any unintended or unauthorized application, customers and users will (a) be solely responsible for any damages, losses or penalties arising in connection therewith or as a result thereof, and (b) indemnify and hold Diodes and its representatives and agents harmless against any and all claims, damages, expenses, and attorney fees arising out of, directly or indirectly, any claim relating to any noncompliance with the applicable laws and regulations, as well as any unintended or unauthorized application.
7. While efforts have been made to ensure the information contained in this document is accurate, complete and current, it may contain technical inaccuracies, omissions and typographical errors. Diodes does not warrant that information contained in this document is error-free and Diodes is under no obligation to update or otherwise correct this information. Notwithstanding the foregoing, Diodes reserves the right to make modifications, enhancements, improvements, corrections or other changes without further notice to this document and any product described herein. This document is written in English but may be translated into multiple languages for reference. Only the English version of this document is the final and determinative format released by Diodes.
8. Any unauthorized copying, modification, distribution, transmission, display or other use of this document (or any portion hereof) is prohibited. Diodes assumes no responsibility for any losses incurred by the customers or users or any third parties arising from any such unauthorized use.
9. This Notice may be periodically updated with the most recent version available at <https://www.diodes.com/about/company/terms-and-conditions/important-notice>

The Diodes logo is a registered trademark of Diodes Incorporated in the United States and other countries.
All other trademarks are the property of their respective owners.
© 2024 Diodes Incorporated. All Rights Reserved.

www.diodes.com