

Description

The BYP53/54 are plastic sealed 25A- diodes, which are available in different reverse voltage classes up to 800V.

The diodes can be delivered with limited forward voltage and reverse current differences for parallel connecting in rectifier stacks and back-off-diodes

Features

- Forward current 25A
- Reverse voltage 75V – 800V
- Hermetic press-fit package
- Available in different modifications of the package
- For automotive applications requiring specific change control (i.e. parts qualified to AEC-Q100/101/200, PPAP capable, and manufactured in IATF 16949 certified facilities), please [contact us](#) or your local Diodes representative.
<https://www.diodes.com/quality/product-definitions/>

Applications

- Power supplies
- Rectifier diode in car generators
- Rectifier bridges/stacks
- Back-off-diodes

Pinout details

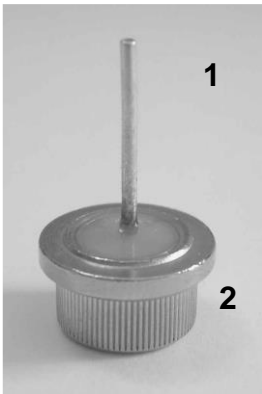

- BYP53:** 1 - cathode
2 - anode
- BYP54:** 1 - anode
2 - cathode

Typical application circuit

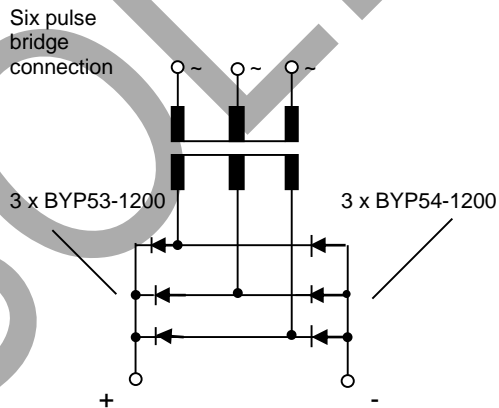

Ordering information

Device	Quantity per box	Options
BYP53-75; ...; BYP53-800	400	The package quantities for the different package modifications are included in "PressFitPackageModifications.pdf"
BYP54-75; ...; BYP54-800	400	

Device marking

Devices are identified by type. Colour of marking: **BYP53- black, BYP54 – red**

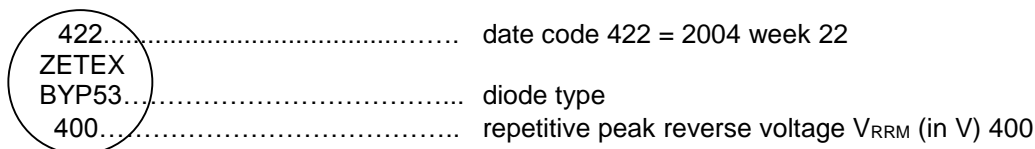

OBSOLETE – PART DISCONTINUED

Absolute maximum ratings (at $T_{amb} = 25^{\circ}\text{C}$ unless otherwise stated)

Parameter		Symbol		Unit	Test condition	
Repetitive peak reverse voltage	BYP53-75	BYP54-75	V_{RRM}	75	V	$T_c = 140^{\circ}\text{C}$
	BYP53-100	BYP54-100		100		
	BYP53-150	BYP54-150		150		
	BYP53-200	BYP54-200		200		
	BYP53-300	BYP54-300		300		
	BYP53-400	BYP54-400		400		
	BYP53-500	BYP54-500		500		
	BYP53-600	BYP54-600		600		
	BYP53-700	BYP54-700		700		
	BYP53-800	BYP54-800		800		
Forward current, arithmetic value		I_{FAV}		25	A	
Surge forward current		I_{FSM}		425	A	half-sine wave, ≤ 10 ms
				350		$T_J = 175^{\circ}\text{C}$ half-sine wave, ≤ 10 ms
Maximum rated value		$\int i^2 dt$		900	A ² s	half-sine wave, ≤ 10 ms
				780		$T_J = 175^{\circ}\text{C}$ half-sine wave, ≤ 10 ms
Repetitive peak forward current		$I_{FRM} = \pi * I_{FAV}$		79	A	$f = > 15$ Hz
Effective forward current		I_{FRMS}		45	A	
Junction temperature		T_{Jmax}		175	$^{\circ}\text{C}$	
Storage temperature range		T_{stg}		- 50 to + 140	$^{\circ}\text{C}$	

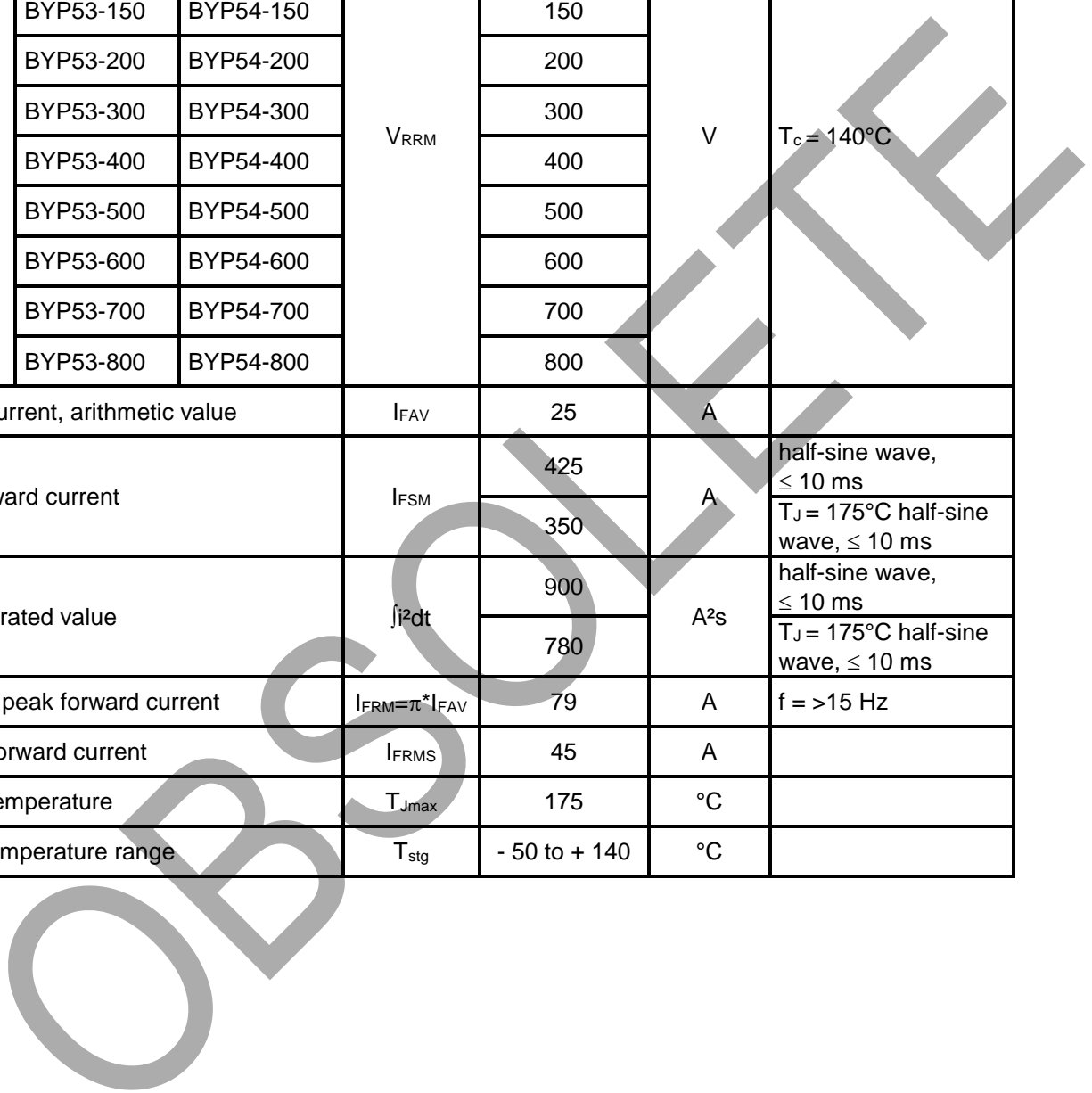
OBSOLETE - PART DISCONTINUED

OBSOLETE - PART DISCONTINUED

Thermal resistance

Parameter	Symbol	Value	Unit
Junction to case	$R_{\theta JC}$	1.2	$^{\circ}C/W$

Thermal characteristics

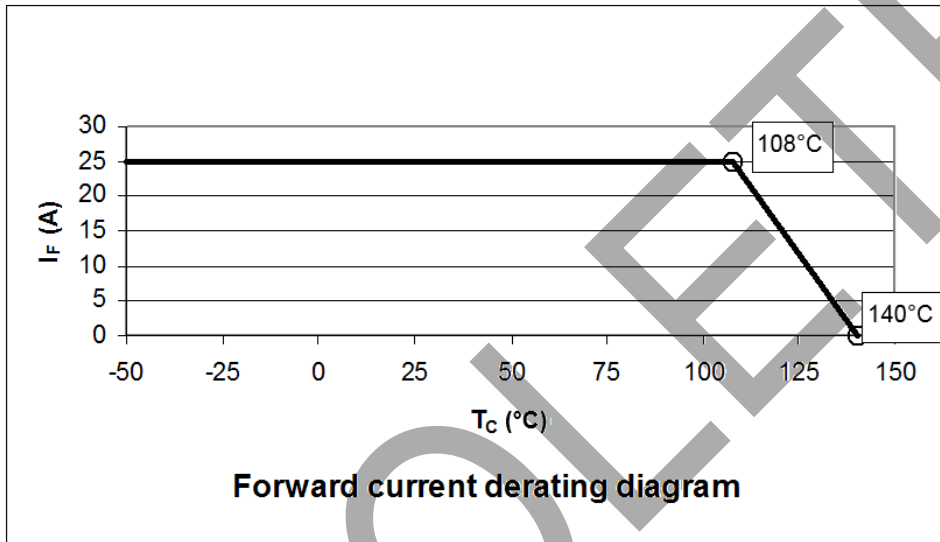

Electrical characteristics (at $T_{amb} = 25^{\circ}C$ unless otherwise stated)

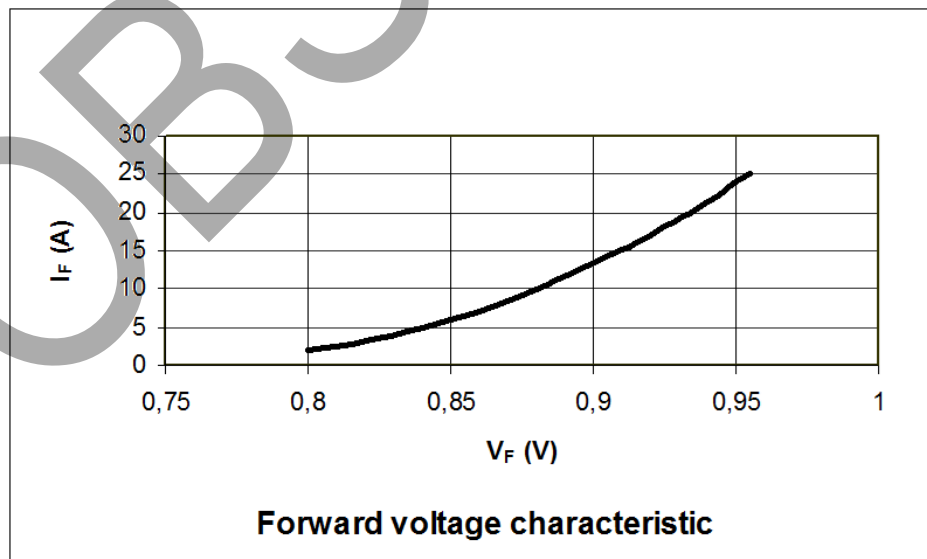

Electrical characteristics (at $T_{amb} = 25^{\circ}\text{C}$ unless otherwise stated)

Parameter		Symbol	Min.	Typ.	Max.	Unit	Test conditions
Forward voltage	BYP53-75...800 BYP54-75...800	V_F	-	0.95	1.1	V	$I_F = 25\text{ A}$, measuring time 10ms (half-sine wave)
Forward voltage (information values)	BYP53-75...800 BYP54-75...800	V_F	-	-	1.2	V	$I_F = 35\text{ A}$,
Reverse current	BYP53-75...150 BYP54-75...150	I_{RRM}	-	-	3	mA	$T_J = 140^{\circ}\text{C}$, at V_{RRM}
	BYP53-200...800 BYP54-200...800		-	-	1.5		
	BYP53-75...400 BYP54-75...400	I_{RRM}	-	-	0.25	mA	at V_{RRM}
	BYP53-500...800 BYP54-500...800		-	-	0.1		
Threshold voltage (information value)		$V_{(FO)}$	-	0.66	-	V	$T_J = 175^{\circ}\text{C}$
Slope resistance (information value)		r_F	-	5.75	-	m Ω	$T_J = 175^{\circ}\text{C}$

Options: Electrical characteristics for parallel connecting

 (at $T_{amb} = 25^{\circ}\text{C}$ unless otherwise stated)

Option	Parameter	Symbol	Min.	Typ.	Max.	Unit	Test conditions
1	Forward voltage difference in one category of forward voltage	ΔV_F	-	-	0.05	V	$I_F = 25\text{ A}$, measuring time 10ms (half-sine wave)
2	Reverse current in one category of forward voltage (only for BYP53-300...800 and BYP54-300...800)	I_R	-	-	0.01	mA	at V_{RRM}

Packaging details

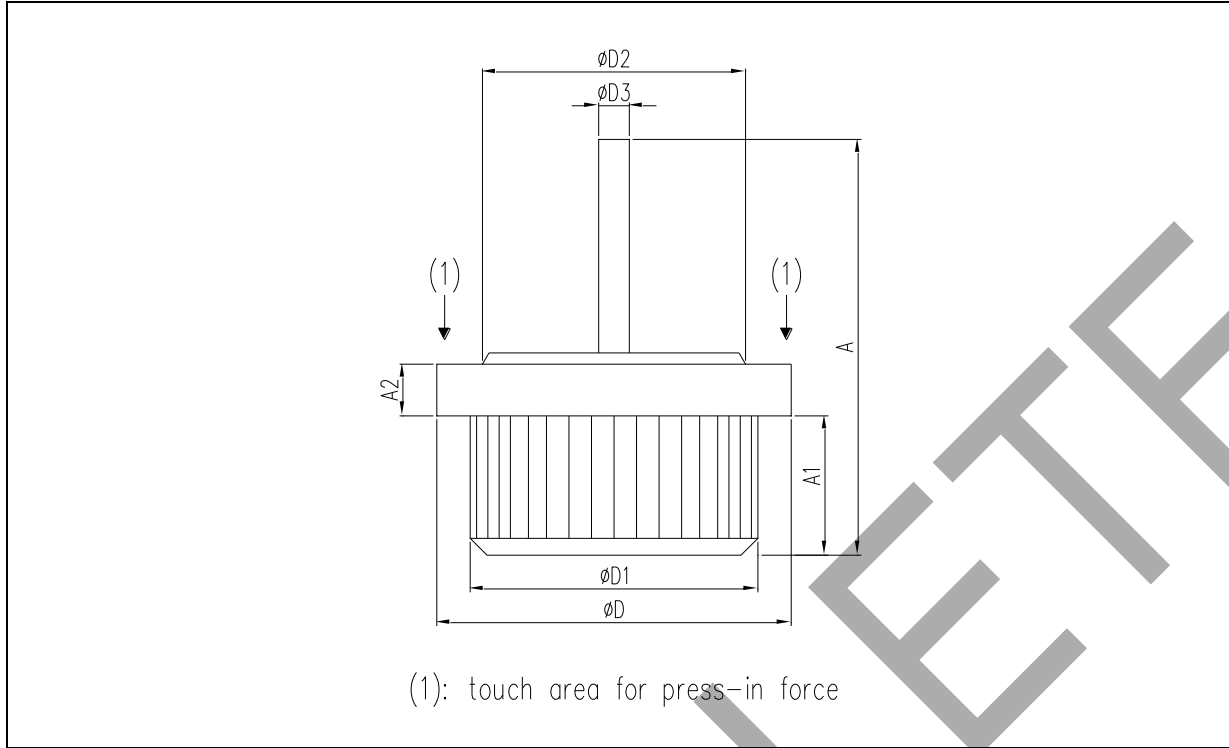

Package dimensions

Dimensions in millimeters are control dimensions, dimensions in inches are approximate

DIM	Millimeters			Inches		
	MIN	TYP	MAX	MIN	TYP	MAX
A	18,00	18,50	19,00	0,709	0,728	0,748
A1	5,90	6,10	6,30	0,232	0,240	0,248
A2	2,10	2,30	2,50	0,083	0,091	0,098
D	15,50	15,70	15,90	0,610	0,618	0,626
D1	12,72	12,77	12,82	0,501	0,503	0,505
D2	11,50	11,70	11,90	0,453	0,461	0,469
D3	1,33	1,36	1,39	0,052	0,054	0,055

OBSOLETE - PART DISCONTINUED

IMPORTANT NOTICE

DIODES INCORPORATED MAKES NO WARRANTY OF ANY KIND, EXPRESS OR IMPLIED, WITH REGARDS TO THIS DOCUMENT, INCLUDING, BUT NOT LIMITED TO, THE IMPLIED WARRANTIES OF MERCHANTABILITY AND FITNESS FOR A PARTICULAR PURPOSE (AND THEIR EQUIVALENTS UNDER THE LAWS OF ANY JURISDICTION).

Diodes Incorporated and its subsidiaries reserve the right to make modifications, enhancements, improvements, corrections or other changes without further notice to this document and any product described herein. Diodes Incorporated does not assume any liability arising out of the application or use of this document or any product described herein; neither does Diodes Incorporated convey any license under its patent or trademark rights, nor the rights of others. Any Customer or user of this document or products described herein in such applications shall assume all risks of such use and will agree to hold Diodes Incorporated and all the companies whose products are represented on Diodes Incorporated website, harmless against all damages.

Diodes Incorporated does not warrant or accept any liability whatsoever in respect of any products purchased through unauthorized sales channel. Should Customers purchase or use Diodes Incorporated products for any unintended or unauthorized application, Customers shall indemnify and hold Diodes Incorporated and its representatives harmless against all claims, damages, expenses, and attorney fees arising out of, directly or indirectly, any claim of personal injury or death associated with such unintended or unauthorized application.

Products described herein may be covered by one or more United States, international or foreign patents pending. Product names and markings noted herein may also be covered by one or more United States, international or foreign trademarks.

This document is written in English but may be translated into multiple languages for reference. Only the English version of this document is the final and determinative format released by Diodes Incorporated.

LIFE SUPPORT

Diodes Incorporated products are specifically not authorized for use as critical components in life support devices or systems without the express written approval of the Chief Executive Officer of Diodes Incorporated. As used herein:

A. Life support devices or systems are devices or systems which:

1. are intended to implant into the body, or
2. support or sustain life and whose failure to perform when properly used in accordance with instructions for use provided in the labeling can be reasonably expected to result in significant injury to the user.

B. A critical component is any component in a life support device or system whose failure to perform can be reasonably expected to cause the failure of the life support device or to affect its safety or effectiveness.

Customers represent that they have all necessary expertise in the safety and regulatory ramifications of their life support devices or systems, and acknowledge and agree that they are solely responsible for all legal, regulatory and safety-related requirements concerning their products and any use of Diodes Incorporated products in such safety-critical, life support devices or systems, notwithstanding any devices- or systems-related information or support that may be provided by Diodes Incorporated. Further, Customers must fully indemnify Diodes Incorporated and its representatives against any damages arising out of the use of Diodes Incorporated products in such safety-critical, life support devices or systems.

Copyright © 2020, Diodes Incorporated

www.diodes.com