

**5 CHANNEL HIGH SURGE BIDIRECTIONAL TVS DIODE**
**Product Summary**

<b>V<sub>BR</sub> Min</b>	<b>I<sub>pp</sub> Max</b>	<b>C<sub>IN</sub> Typ</b>
5.5V	12A	35pF

**Description**

This new generation TVS is designed to protect sensitive electronics from the damage due to ESD. The combination of small size and high ESD surge capability makes it ideal for use in portable applications such as cellular phones, digital cameras and MP3 players.

**Applications**

- Cellular Handsets
- Portable Electronics
- Computers and Peripheral

**Features**

- Provides ESD Protection per IEC 61000-4-2 Standard: Air ±30kV, Contact ±30kV
- 1 Channel of ESD Protection
- Low Channel Input Capacitance
- **Totally Lead-Free & Fully RoHS Compliant (Notes 1 & 2)**
- **Halogen and Antimony Free. "Green" Device (Note 3)**
- **For automotive applications requiring specific change control (i.e. parts qualified to AEC-Q100/101/200, PPAP capable, and manufactured in IATF 16949 certified facilities), please [contact us](mailto:contact@diodes.com) or your local Diodes representative. <https://www.diodes.com/quality/product-definitions/>**

**Mechanical Data**

- Case: U-DFN1616-6
- Case Material: Molded Plastic, "Green" Molding Compound; UL Flammability Classification Rating 94V-0
- Moisture Sensitivity: Level 1 per J-STD-020
- Terminals: NiPdAu over Copper Leadframe. Solderable per MIL-STD-202, Method 208 (e4)
- Weight: 0.004 grams (Approximate)

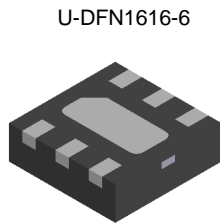

Bottom View

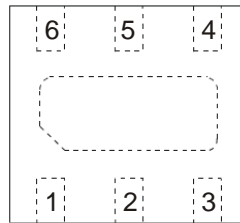

Top View

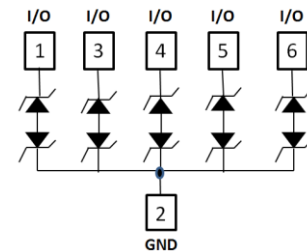

Device Schematic

**Ordering Information (Note 4)**

Part Number	Compliance	Marking Code	Reel Size (inches)	Tape Width (mm)	Quantity per Reel
D5V0M5B6LP16-7	Standard	H9	7	8	3,000/Tape & Reel

- Notes:
1. No purposely added lead. Fully EU Directive 2002/95/EC (RoHS), 2011/65/EU (RoHS 2) & 2015/863/EU (RoHS 3) compliant.
  2. See <https://www.diodes.com/quality/lead-free/> for more information about Diodes Incorporated's definitions of Halogen- and Antimony-free, "Green" and Lead-free.
  3. Halogen- and Antimony-free "Green" products are defined as those which contain <900ppm bromine, <900ppm chlorine (<1500ppm total Br + Cl) and <1000ppm antimony compounds.
  4. For packaging details, go to our website at <https://www.diodes.com/design/support/packaging/diodes-packaging/>.

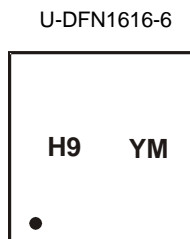
**Marking Information**

H9 = Product Type Marking Code  
 YM = Date Code Marking  
 Y = Year (ex: 1 = 2021)  
 M = Month (ex: 9 = September)

**Date Code Key**

Year	2015	...	2021	2022	2023	2024	2025	2026	2027	2028	2029	2030
Code	C	...	I	J	K	L	M	N	O	P	R	S

Month	Jan	Feb	Mar	Apr	May	Jun	Jul	Aug	Sep	Oct	Nov	Dec
Code	1	2	3	4	5	6	7	8	9	O	N	D

**Maximum Ratings** (@T<sub>A</sub> = +25°C, unless otherwise specified.)

Characteristic	Symbol	Value	Unit	Conditions
Peak Pulse Power Dissipation	PPP	130	W	8/20μs, per Figure 1
Peak Pulse Current	I <sub>PP</sub>	12	A	8/20μs, per Figure 1
ESD Protection – Contact Discharge	V <sub>ESD_Contact</sub>	±30	kV	IEC 61000-4-2 Standard
ESD Protection – Air Discharge	V <sub>ESD_Air</sub>	±30	kV	IEC 61000-4-2 Standard

**Thermal Characteristics**

Characteristic	Symbol	Value	Unit
Package Power Dissipation (Note 5)	P <sub>D</sub>	250	mW
Thermal Resistance, Junction to Ambient (Note 5)	R <sub>θJA</sub>	500	°C/W
Operating and Storage Temperature Range	T <sub>J</sub> , T <sub>STG</sub>	-65 to +150	°C

**Electrical Characteristics** (@T<sub>A</sub> = +25°C, unless otherwise specified.)

Characteristic	Symbol	Min	Typ	Max	Unit	Test Conditions
Reverse Standoff Voltage	V <sub>RWM</sub>	—	—	5	V	—
Channel Leakage Current (Note 6)	I <sub>RM</sub>	—	5	100	nA	V <sub>RWM</sub> = 5V
Clamping Voltage, Positive Transients	V <sub>CL</sub>	—	—	10	V	I <sub>PP</sub> = 1A, t <sub>p</sub> = 8/20μs
		—	—	14		I <sub>PP</sub> = 12A, t <sub>p</sub> = 8/20μs
Breakdown Voltage	V <sub>BR</sub>	5.5	—	9.5	V	I <sub>R</sub> = 1mA
Differential Resistance	R <sub>DIF</sub>	—	0.4	—	Ω	I <sub>R</sub> = 10A, t <sub>p</sub> = 8/20μs
Channel Input Capacitance	C <sub>IN</sub>	—	35	40	pF	V <sub>R</sub> = 0V, f = 1MHz

- Notes:
5. Device mounted on FR-4 PCB pad layout (2oz copper) as shown on Diodes Incorporated's suggested pad layout, which can be found on our website at <http://www.diodes.com/package-outlines.html>.
  6. Short duration pulse test used to minimize self-heating effect.

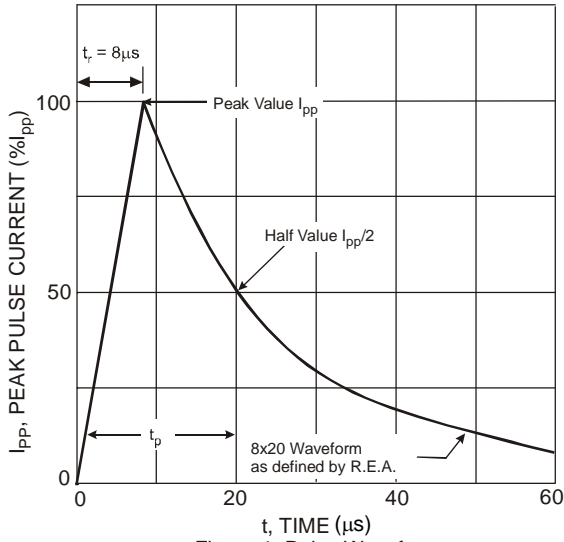

Figure 1 Pulse Waveform

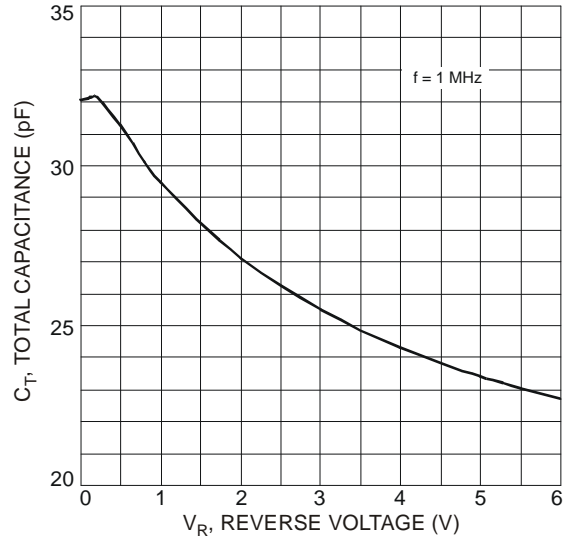

Fig. 2 Typical Total Capacitance vs. Reverse Voltage

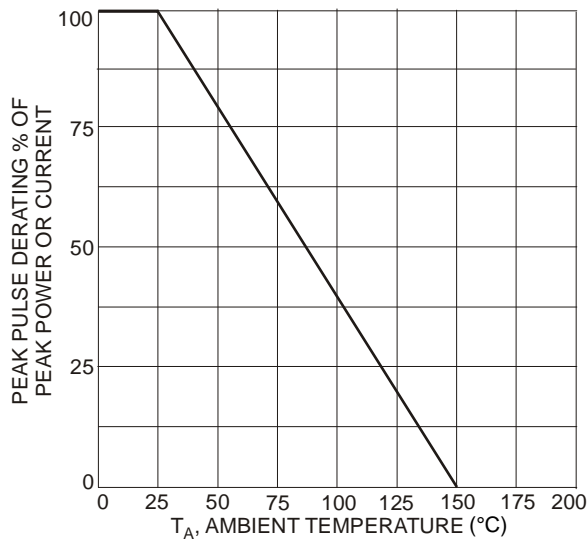

Figure 3 Pulse Derating Curve

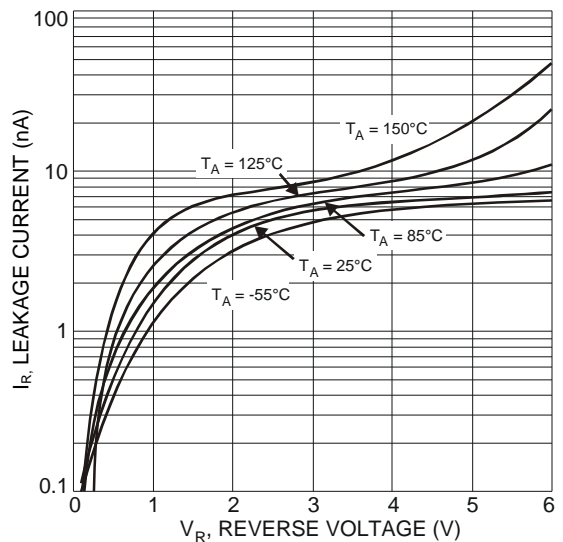
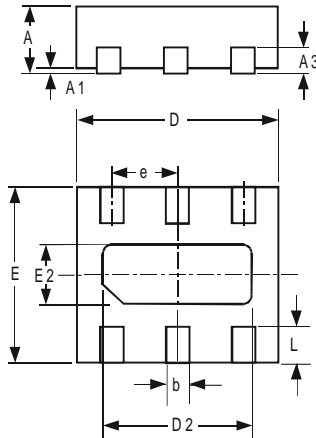

Figure 4 Typical Reverse Characteristics

**Package Outline Dimensions**

Please see <http://www.diodes.com/package-outlines.html> for the latest version.

**U-DFN1616-6**



U-DFN1616-6			
Dim	Min	Max	Typ
A	0.545	0.605	0.575
A1	0	0.05	0.02
A3	—	—	0.13
b	0.20	0.30	0.25
D	1.55	1.675	1.60
D2	1.10	1.30	1.20
E	1.55	1.675	1.60
e	—	—	0.50
E2	0.30	0.50	0.40
L	0.275	0.375	0.325
All Dimensions in mm			

**Suggested Pad Layout**

Please see <http://www.diodes.com/package-outlines.html> for the latest version.

**U-DFN1616-6**

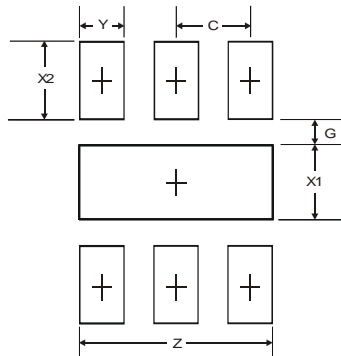

Dimensions	Value (in mm)
Z	1.3
G	0.175
X1	0.50
X2	0.525
Y	0.30
C	0.50

**IMPORTANT NOTICE**

1. DIODES INCORPORATED AND ITS SUBSIDIARIES ("DIODES") MAKE NO WARRANTY OF ANY KIND, EXPRESS OR IMPLIED, WITH REGARDS TO ANY INFORMATION CONTAINED IN THIS DOCUMENT, INCLUDING, BUT NOT LIMITED TO, THE IMPLIED WARRANTIES OF MERCHANTABILITY, FITNESS FOR A PARTICULAR PURPOSE OR NON-INFRINGEMENT OF THIRD PARTY INTELLECTUAL PROPERTY RIGHTS (AND THEIR EQUIVALENTS UNDER THE LAWS OF ANY JURISDICTION).
2. The Information contained herein is for informational purpose only and is provided only to illustrate the operation of Diodes products described herein and application examples. Diodes does not assume any liability arising out of the application or use of this document or any product described herein. This document is intended for skilled and technically trained engineering customers and users who design with Diodes products. Diodes products may be used to facilitate safety-related applications; however, in all instances customers and users are responsible for (a) selecting the appropriate Diodes products for their applications, (b) evaluating the suitability of the Diodes products for their intended applications, (c) ensuring their applications, which incorporate Diodes products, comply the applicable legal and regulatory requirements as well as safety and functional-safety related standards, and (d) ensuring they design with appropriate safeguards (including testing, validation, quality control techniques, redundancy, malfunction prevention, and appropriate treatment for aging degradation) to minimize the risks associated with their applications.
3. Diodes assumes no liability for any application-related information, support, assistance or feedback that may be provided by Diodes from time to time. Any customer or user of this document or products described herein will assume all risks and liabilities associated with such use, and will hold Diodes and all companies whose products are represented herein or on Diodes' websites, harmless against all damages and liabilities.
4. Products described herein may be covered by one or more United States, international or foreign patents and pending patent applications. Product names and markings noted herein may also be covered by one or more United States, international or foreign trademarks and trademark applications. Diodes does not convey any license under any of its intellectual property rights or the rights of any third parties (including third parties whose products and services may be described in this document or on Diodes' website) under this document.
5. Diodes products are provided subject to Diodes' Standard Terms and Conditions of Sale (<https://www.diodes.com/about/company/terms-and-conditions/terms-and-conditions-of-sales/>) or other applicable terms. This document does not alter or expand the applicable warranties provided by Diodes. Diodes does not warrant or accept any liability whatsoever in respect of any products purchased through unauthorized sales channel.
6. Diodes products and technology may not be used for or incorporated into any products or systems whose manufacture, use or sale is prohibited under any applicable laws and regulations. Should customers or users use Diodes products in contravention of any applicable laws or regulations, or for any unintended or unauthorized application, customers and users will (a) be solely responsible for any damages, losses or penalties arising in connection therewith or as a result thereof, and (b) indemnify and hold Diodes and its representatives and agents harmless against any and all claims, damages, expenses, and attorney fees arising out of, directly or indirectly, any claim relating to any noncompliance with the applicable laws and regulations, as well as any unintended or unauthorized application.
7. While efforts have been made to ensure the information contained in this document is accurate, complete and current, it may contain technical inaccuracies, omissions and typographical errors. Diodes does not warrant that information contained in this document is error-free and Diodes is under no obligation to update or otherwise correct this information. Notwithstanding the foregoing, Diodes reserves the right to make modifications, enhancements, improvements, corrections or other changes without further notice to this document and any product described herein. This document is written in English but may be translated into multiple languages for reference. Only the English version of this document is the final and determinative format released by Diodes.
8. Any unauthorized copying, modification, distribution, transmission, display or other use of this document (or any portion hereof) is prohibited. Diodes assumes no responsibility for any losses incurred by the customers or users or any third parties arising from any such unauthorized use.

Copyright © 2021 Diodes Incorporated

[www.diodes.com](http://www.diodes.com)