

Description

The DGD0636 is a three-phase gate driver IC designed for high-voltage / high-speed applications, driving N-Channel MOSFETs and IGBTs in a half-bridge configuration. High-voltage processing techniques enable the DGD0636's high-side to switch to 100V in a bootstrap operation.

The DGD0636 logic inputs are compatible with standard TTL and CMOS levels (down to 3.3V) for easy interfacing with controlling devices and are enabled low to better function in high noise environments. The driver outputs feature high pulse current buffers designed for minimum driver cross conduction.

The DGD0636 offers numerous protection functions. A shoot-through protection logic prevents both outputs from being high when both inputs are high (fault state), and an undervoltage lockout for VCC shuts down the respective high-side output. Overcurrent protection will terminate the six outputs. Both the VCC UVLO and the overcurrent protection trip an automatic fault clear with a timing that is adjustable with an external capacitor.

The DGD0636 is offered in SO-28 package and the operating temperature extends from -40°C to +125°C.

Applications

- 3-Phase Motor Inverter Driver
- BLDC Motor Driver
- Industrial Motor Inverter – Power Tools, Robotics
- General Purpose 3-Phase Inverter

Features

- Three Floating High-Side Drivers in Bootstrap Operation to 100V
- 200mA Source / 350mA Sink Output Current Capability
- Outputs Tolerant to Negative Transients, dV/dt Immune
- Logic Input 3.3V Capability
- Internal Deadtime of 290ns to Protect MOSFETs
- Matched Prop Delay for All Channels
- Outputs Out of Phase with Inputs
- Schmitt Triggered Logic Inputs
- Cross Conduction Prevention Logic
- Undervoltage Lockout for All Channels
- Overcurrent Protection Shuts Down Drivers
- Extended Temperature Range: -40°C to +125°C
- **Totally Lead-Free & Fully RoHS Compliant (Notes 1 & 2)**
- **Halogen and Antimony free. "Green" Device (Note 3)**

Mechanical Data

- Case: SO-28 (Type TH)
- Case Material: Molded Plastic. "Green" Molding Compound. UL Flammability Classification Rating 94V-0
- Moisture Sensitivity: Level 3 per J-STD-020
- Terminals: Finish – Matte Tin Plated Leads, Solderable per MIL-STD-202, Method 208 
- Weight: 0.250 grams (Approximate)

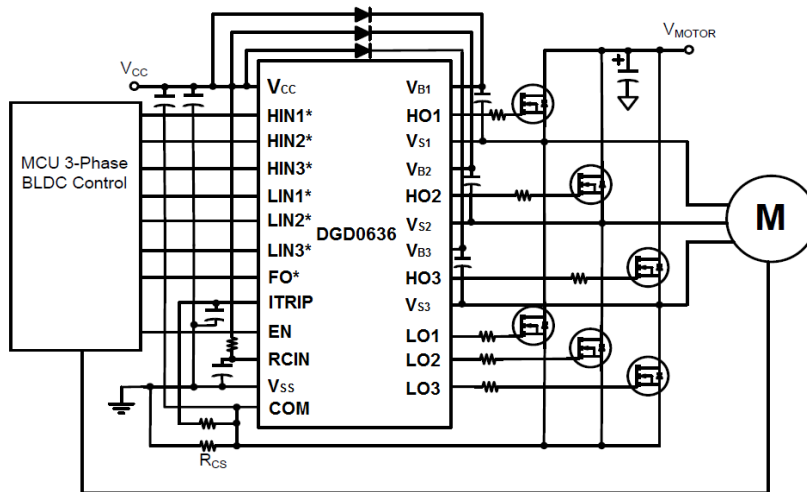

Typical Configuration

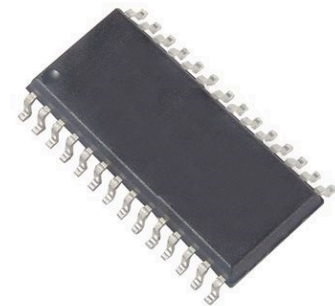

SO-28
Top View

Ordering Information (Note 4)

Part Number	Marking	Reel Size (inches)	Tape Width (mm)	Quantity Per Reel
DGD0636S28-13	DGD0636	13	24	1,500

- Notes:
1. No purposely added lead. Fully EU Directive 2002/95/EC (RoHS), 2011/65/EU (RoHS 2) & 2015/863/EU (RoHS 3) compliant.
 2. See <https://www.diodes.com/quality/lead-free/> for more information about Diodes Incorporated's definitions of Halogen- and Antimony-free, "Green" and Lead-free.
 3. Halogen- and Antimony-free "Green" products are defined as those which contain <900ppm bromine, <900ppm chlorine (<1500ppm total Br + Cl) and <1000ppm antimony compounds.
 4. For packaging details, go to our website at <https://www.diodes.com/design/support/packaging/diodes-packaging/>.

Marking Information

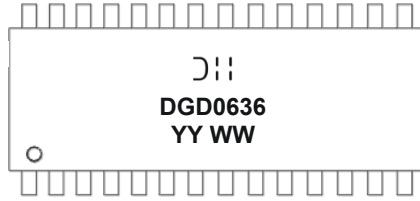

DII = Manufacturer's marking
 DGD0636 = Product Type Marking Code
 YY = Year (ex: 19 = 2019)
 WW = Week (01 to 53)

Pin Diagrams

(Top View)

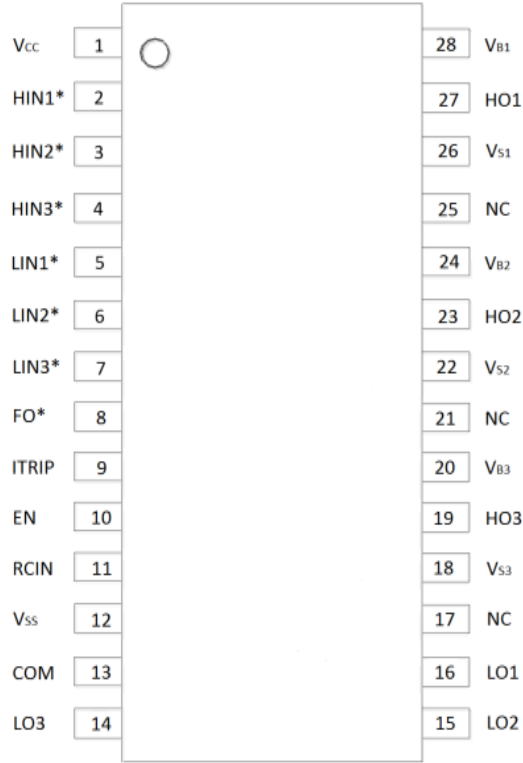

SO-28

OBSOLETE - PART DISCONTINUED

OBSOLETE

Pin Descriptions

Pin Number	Pin Name	Function
1	V _{CC}	Low-Side and Logic Fixed Supply
2, 3, 4	HIN1*, HIN2*, HIN3*	Logic Input for High-Side Gate Driver Output, Out of Phase with HO
5, 6, 7	LIN1*, LIN2*, LIN3*	Logic Input for Low-Side Gate Driver Output, Out of Phase with LO
8	FO*	Fault Output with Open Drain (Fault with Overcurrent and V _{CC} UVLO)
9	ITRIP	Analog Input for Overcurrent Shutdown
10	EN	Logic Input for Functionality, I/O Logic Functions when EN is High
11	RCIN	An External RC Network Input used to Define FAULT CLEAR Delay
12	V _{SS}	Logic Ground
13	COM	Low-Side Driver Return
14, 15, 16	LO3, LO2, LO1	Low-Side Gate Driver Output
17, 21, 25	NC	No Connection (No Internal Connection)
18, 22, 26	V _{S3} , V _{S2} , V _{S1}	High-Side Floating Supply Return
19, 23, 27	HO3, HO2, HO1	High-Side Gate Driver Output
20, 24, 28	V _{B3} , V _{B2} , V _{B1}	High-Side Floating Supply

Functional Block Diagram

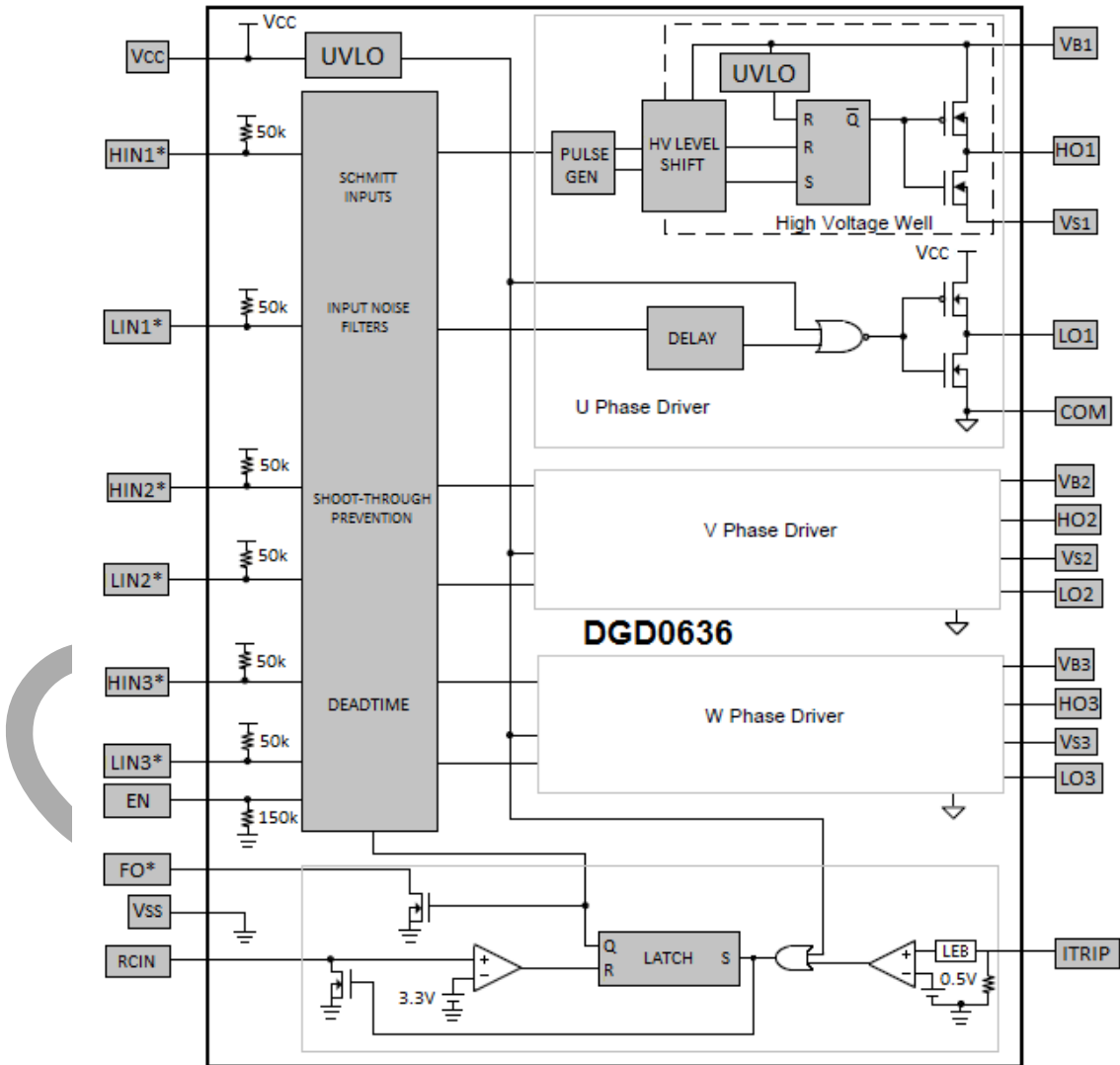

OBSOLETE - PART DISCONTINUED

Absolute Maximum Ratings (@T_A = +25°C, unless otherwise specified.)

Characteristic	Symbol	Value	Unit
High-Side Floating Supply Voltage	V _B	-0.3 to +124	V
High-Side Floating Supply Offset Voltage	V _S	V _B -24 to V _B +0.3	V
High-Side Floating Output Voltage	V _{HO}	V _S -0.3 to V _B +0.3	V
Low-Side Output Voltage	V _{LO}	-0.3 to V _{CC} +0.3	V
Offset Supply Voltage Transient	dV _S / dt	50	V/ns
Low-Side Fixed Supply Voltage	V _{CC}	-0.3 to +24	V
Logic Input Voltage (HIN*, LIN*, ITRIP, EN and FO*)	V _{IN}	-0.3 to +5.5	V

Thermal Characteristics (@T_A = +25°C, unless otherwise specified.)

Characteristic	Symbol	Value	Unit
Power Dissipation Linear Derating Factor (Note 5)	P _D	2.3	W
Thermal Resistance, Junction to Ambient (Note 5)	R _{θJA}	60	°C/W
Thermal Resistance, Junction to Case (Note 5)	R _{θJC}	45	°C/W
Operating Temperature	T _J	+150	°C
Lead Temperature (Soldering, 10s)	T _L	+300	
Storage Temperature Range	T _{STG}	-55 to +150	

Note: 5. When mounted on a standard JEDEC 2-layer FR-4 board.

Recommended Operating Conditions

Parameter	Symbol	Min	Max	Unit
High-Side Floating Supply Absolute Voltage	V _B	V _S + 10	V _S + 20	V
High-Side Floating Supply Offset Voltage	V _S	(Note 6)	100	V
High-Side Floating Output Voltage	V _{HO}	V _S	V _B	V
Low-Side Fixed Supply Voltage	V _{CC}	10	20	V
Low-Side Output Voltage	V _{LO}	COM	V _{CC}	V
Logic Input Voltage (HIN*, LIN*, ITRIP & EN)	V _{IN}	V _{SS}	5	V
Fault Output Voltage	V _{FO}	V _{SS}	V _{CC}	V
Logic Ground	V _{SS}	-5	5	V
Ambient Temperature	T _A	-40	+125	°C

Note: 6. Logic operation for V_S of -5V to +100V.

OBSOLETE - PART DISCONTINUED
OBSOLETE

DC Electrical Characteristics ($V_{BIAS} (V_{CC}, V_{BS}) = 15V, @T_A = +25^\circ C$, unless otherwise specified.) (Note 7)

Parameter	Symbol	Min	Typ	Max	Unit	Conditions
Logic "0" Input Voltage	V_{IH}	2.4	—	—	V	—
Logic "1" Input Voltage	V_{IL}	—	—	0.8	V	—
High Level Output Voltage, $V_{BIAS} - V_O$	V_{OH}	—	—	0.1	V	$I_O = 0mA$
Low Level Output Voltage, V_O	V_{OL}	—	—	0.1	V	$I_O = 0mA$
Offset Supply Leakage Current	I_{LK}	—	—	10	μA	$V_B = V_S = 100V$
Quiescent V_{BS} Supply Current	I_{BSQ}	10	85	130	μA	$V_{IN} = 0V$ or $5V, EN = 0V$
Quiescent V_{CC} Supply Current	I_{CCQ}	—	1.1	1.6	mA	$V_{IN} = 0V$ or $5V, EN = 0V$
Logic Input Bias Current (HO=LO=HIGH)	I_{IN+}	—	130	200	μA	$V_{IN} = 0V$
Logic Input Bias Current (HO=LO=LOW)	I_{IN-}	—	3.0	20	μA	$V_{IN} = 5V$
Logic Enable "1" Input Bias Current	I_{EN+}	—	33	80	μA	$V_{EN} = 5V$
Logic Enable "0" Input Bias Current	I_{EN-}	—	—	2.0	μA	$V_{EN} = 0V$
V_{BS} Supply Undervoltage Positive Going Threshold	V_{BSUV+}	7.6	8.9	9.9	V	—
V_{BS} Supply Undervoltage Negative Going Threshold	V_{BSUV-}	7.1	8.3	9.4	V	—
V_{CC} Supply Undervoltage Positive Going Threshold	V_{CCUV+}	7.6	8.9	9.9	V	—
V_{CC} Supply Undervoltage Negative Going Threshold	V_{CCUV-}	7.1	8.3	9.4	V	—
Output High Short Circuit Pulsed Current	I_{O+}	120	200	—	mA	$V_O = 0V, PW \leq 10\mu s$
Output Low Short Circuit Pulsed Current	I_{O-}	250	350	—	mA	$V_O = 15V, PW \leq 10\mu s$
Overcurrent Detect Positive Threshold	V_{ITH+}	400	500	600	mV	—
Overcurrent Detect Negative Threshold	V_{ITH-}	340	420	500	mV	—
Short-Circuit Input Current	I_{CSIN}	6.0	11	16	μA	$V_{CSIN} = 1V$
RCIN Positive Going Threshold Voltage	$V_{RCINTH+}$	7.0	8.4	9.8	V	—
RCIN Negative Going Threshold Voltage	$V_{RCINTH-}$	—	5.0	—	V	—
Fault Output Low Level Voltage	V_{FOL}	—	0.2	0.5	V	$V_{CS} = 1V, I_{FO} = 1.5mA$
RCIN on Resistance	R_{DRCIN}	40	75	110	Ω	$I_{RCIN} = 1.5mA$
Fault Output on Resistance	R_{DSFO}	80	130	180	Ω	$I_{FO} = 1.5mA$

Note: 7. The V_{IN}, V_{TH} and I_{IN} parameters are referenced to V_{SS} and are applicable to all six channels (HIN1*,2*,3* and LIN1*,2*,3*). The V_O and I_O parameters are applicable to the output pins (HO1,2,3 and LO1,2,3) and are referenced to COM.

AC Electrical Characteristics ($V_{BIAS} (V_{CC}, V_{BS}) = 15V, C_L = 1000pF, @T_A = +25^\circ C$, unless otherwise specified.)

Parameter	Symbol	Min	Typ	Max	Unit	Conditions
Turn-On Propagation Delay	t_{ON}	200	330	460	ns	$V_S = 0V$
Turn-Off Propagation Delay	t_{OFF}	200	330	460	ns	$V_S = 0V$
Turn-On Rise Time	t_r	—	90	150	ns	$V_S = 0V$
Turn-Off Fall Time	t_f	—	35	60	ns	$V_S = 0V$
Delay Matching	t_{DM}	—	—	50	ns	—
Enable Low to Output Shutdown Delay	t_{EN}	225	330	425	ns	—
ITRIP Pin Leading-Edge Blanking Time	t_{BLT}	200	300	400	ns	—
Time from ITRIP Triggering to FO*	t_{FLT}	360	550	760	ns	From $V_{ITRIP} = 1V$ to FO* turn off
Time from ITRIP Triggering to All Gate Outputs Turn Off	t_{ITRIP}	420	615	820	ns	From $V_{ITRIP} = 1V$ to starting gate turn off
Input Filtering Time (HIN*, LIN*, EN)	t_{FLTIN}	—	250	—	ns	—
Fault Clear Time	t_{FLTCLR}	—	1.6	—	ms	$C_{RCIN} = 1nF, R_{RCIN} = 2M\Omega$
Deadtime	t_{DT}	200	290	420	ns	—
Deadtime Matching	t_{DTM}	—	—	50	ns	—
Output Pulse Width Matching (Note 8)	t_{PM}	—	50	75	ns	$PW_{IN} > 1\mu s$

Note: 8. t_{PM} is defined as $PW_{IN} - PW_{OUT}$.

Timing Waveforms

OBSOLETE - PART DISCONTINUED

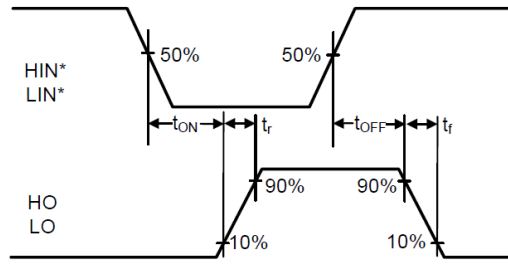

Figure 1. Switching Time Waveform Definitions

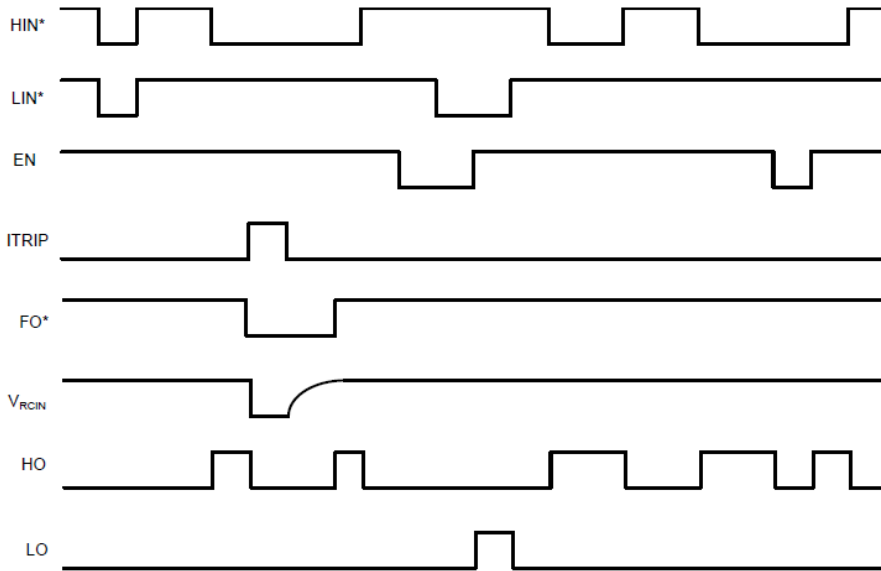

Figure 2. Input/Output Timing Diagram

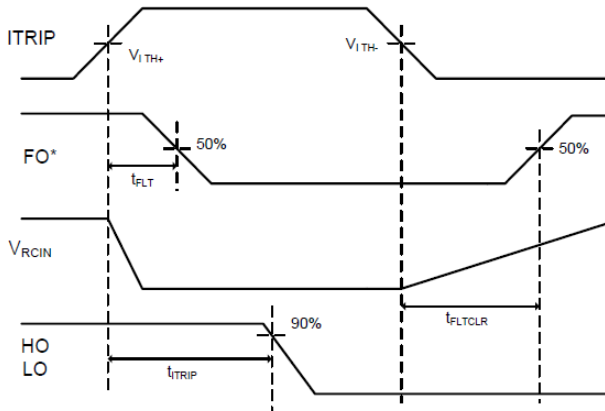

Figure 3. Overcurrent Timing Definitions

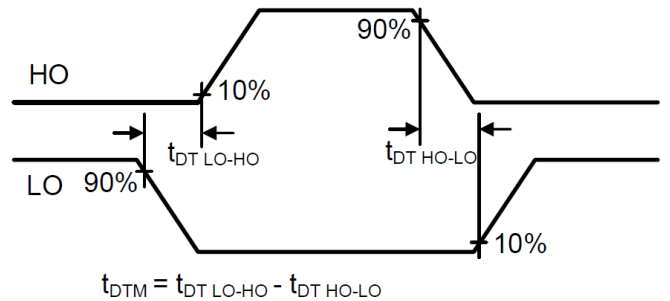

Figure 4. Deadtime Waveform Definitions

Typical Performance Characteristics (@ $T_A = +25^\circ\text{C}$, unless otherwise specified.)

OBSOLETE – PART DISCONTINUED

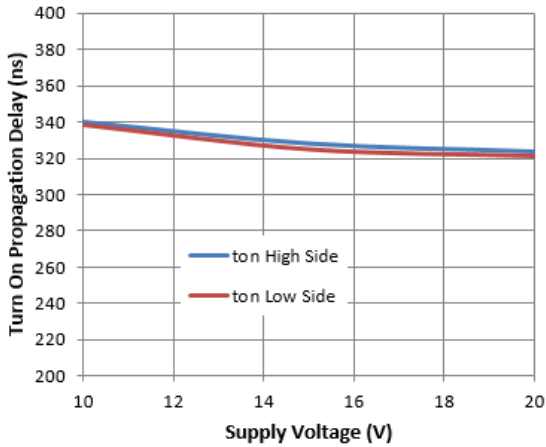

Figure 5. Turn-on Propagation Delay vs. Supply Voltage

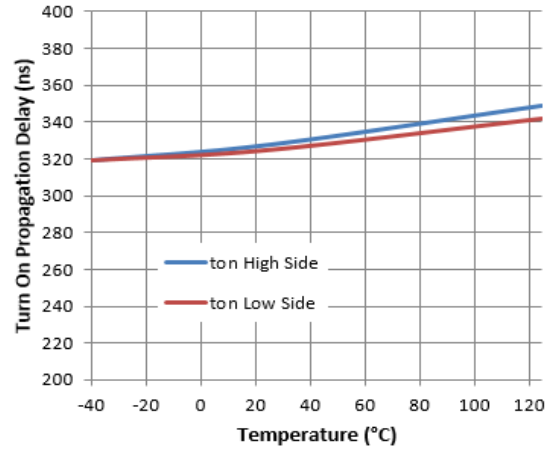

Figure 6. Turn-on Propagation Delay vs. Temperature

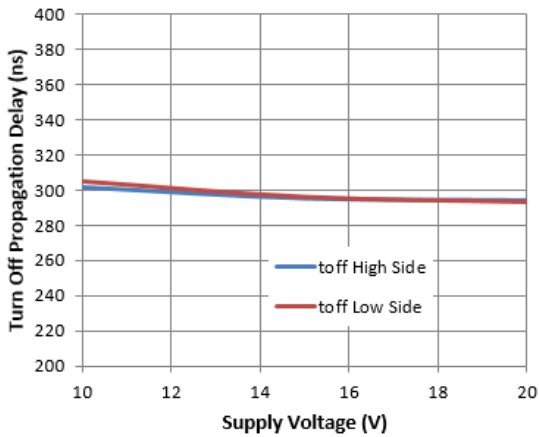

Figure 7. Turn-off Propagation Delay vs. Supply Voltage

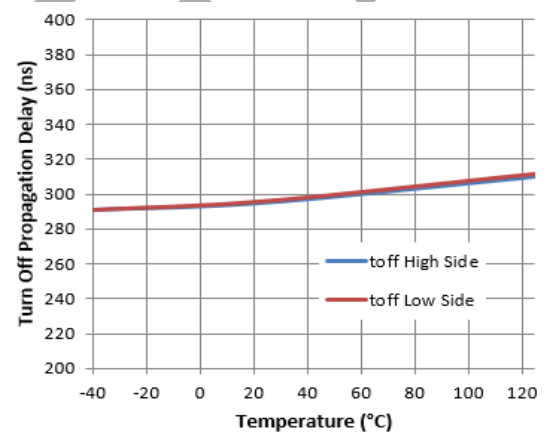

Figure 8. Turn-off Propagation Delay vs. Temperature

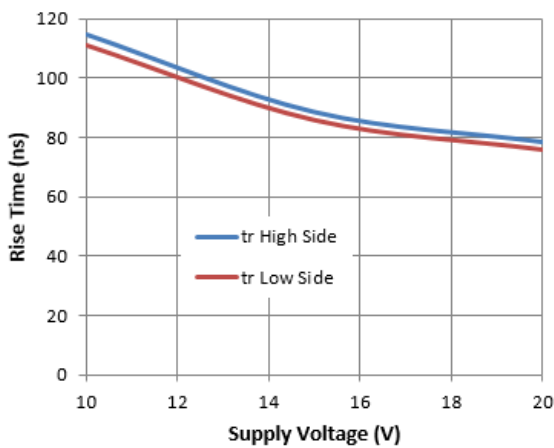

Figure 9. Rise Time vs. Supply Voltage

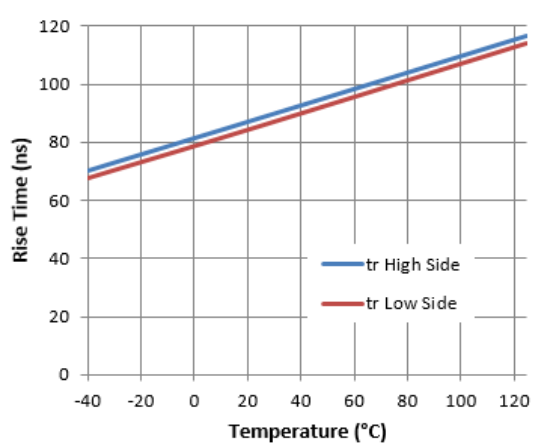

Figure 10. Rise Time vs. Temperature

Typical Performance Characteristics (continued)

OBSOLETE – PART DISCONTINUED

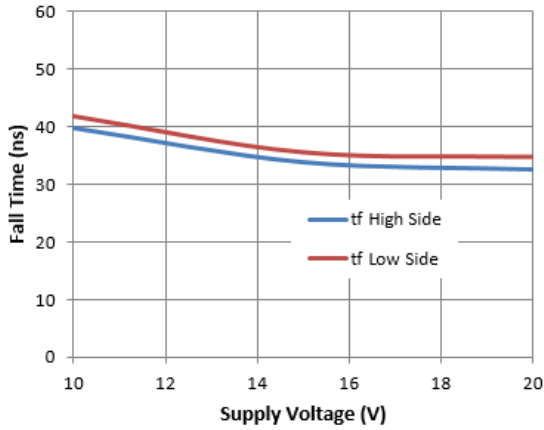

Figure 11. Fall Time vs. Supply Voltage

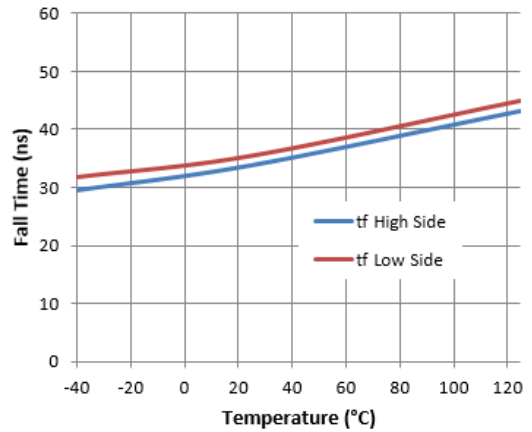

Figure 12. Fall Time vs. Temperature

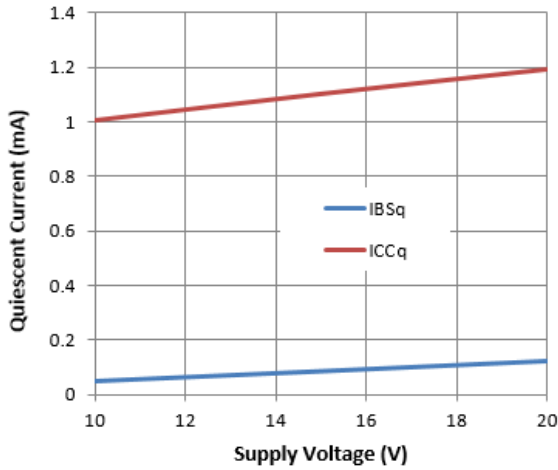

Figure 13. Quiescent Current vs. Supply Voltage

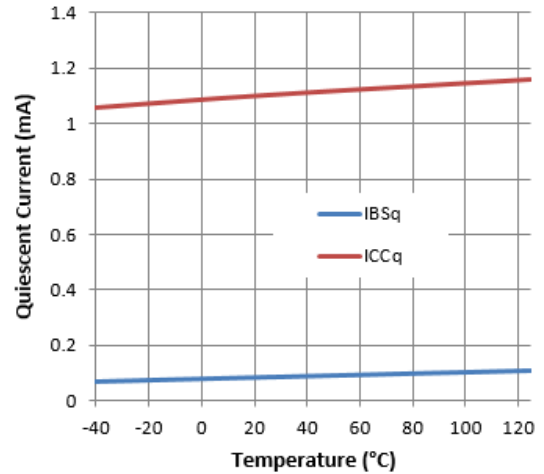

Figure 14. Quiescent Current vs. Temperature

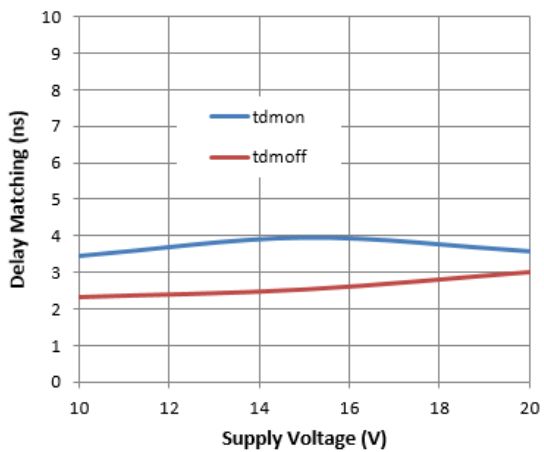

Figure 15. Delay Matching vs. Supply Voltage

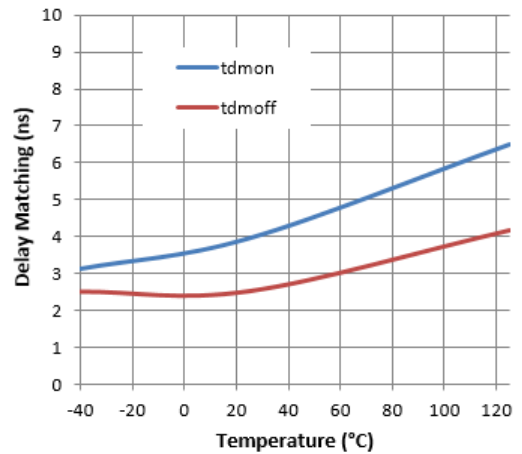

Figure 16. Delay Matching vs. Temperature

Typical Performance Characteristics (continued)

OBSOLETE – PART DISCONTINUED

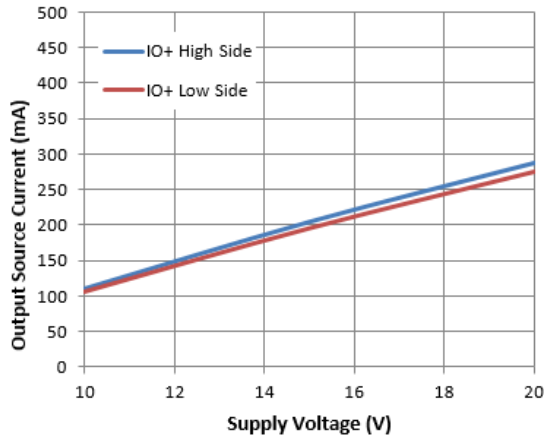

Figure 17. Output Source Current vs. Supply Voltage

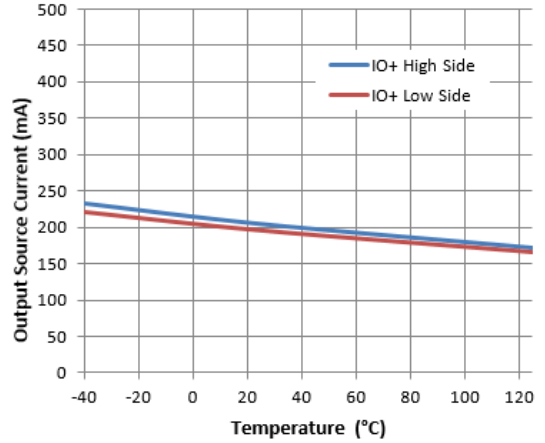

Figure 18. Output Source Current vs. Temperature

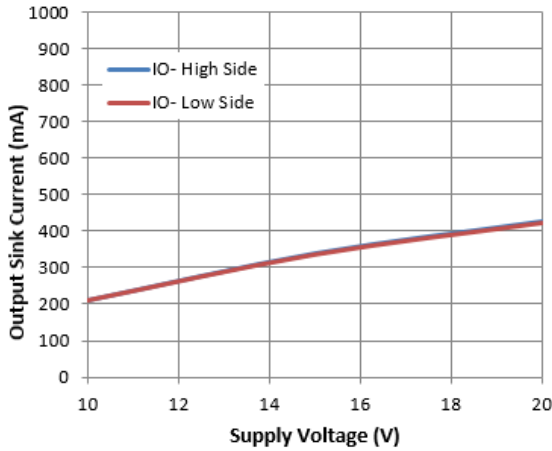

Figure 19. Output Sink Current vs. Supply Voltage

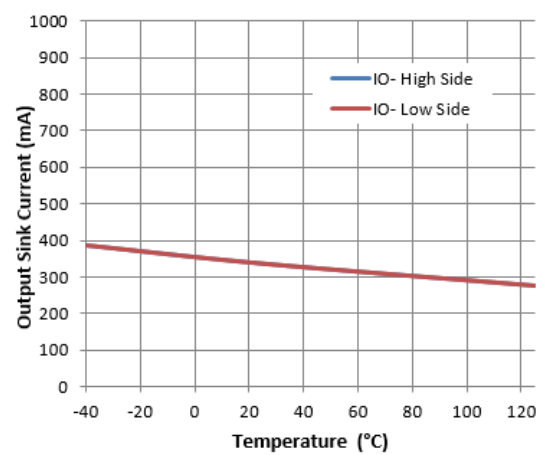

Figure 20. Output Sink Current vs. Temperature

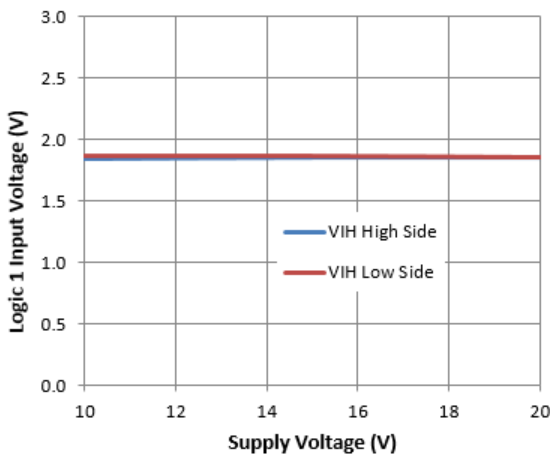

Figure 21. Logic 1 Input Voltage vs. Supply Voltage

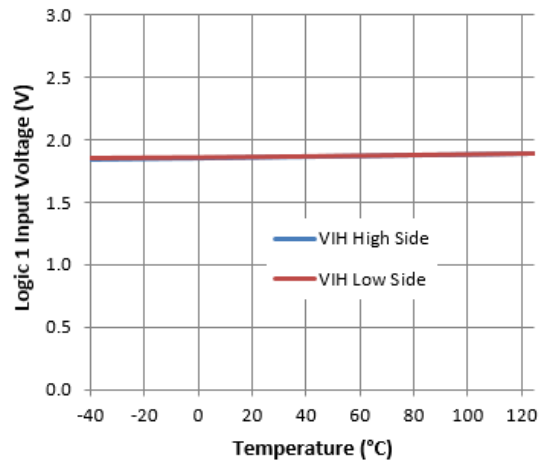

Figure 22. Logic 1 Input Voltage vs. Temperature

Typical Performance Characteristics (continued)

OBSOLETE – PART DISCONTINUED

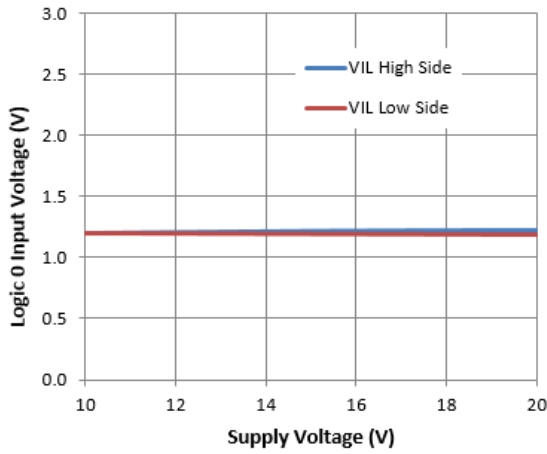

Figure 23. Logic 0 Input Voltage vs. Supply Voltage

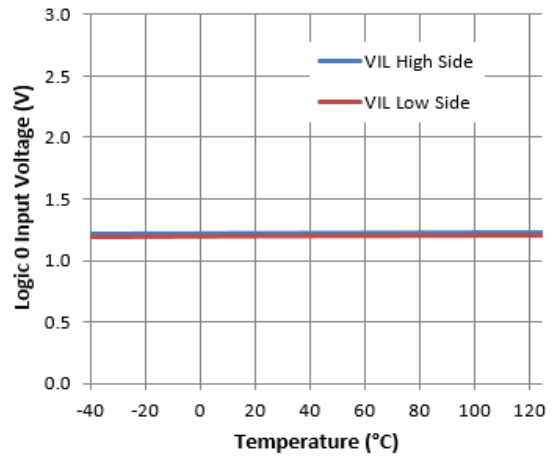

Figure 24. Logic 0 Input Voltage vs. Temperature

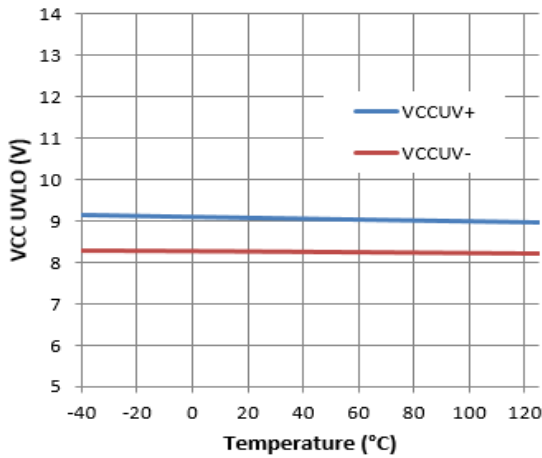

Figure 25. VCC UVLO vs. Temperature

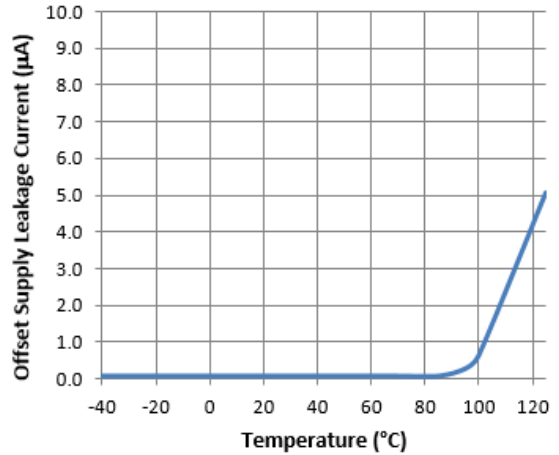

Figure 26. Offset Supply Leakage Current vs. Temperature

OBSOLETE

Package Outline Dimensions

Please see <http://www.diodes.com/package-outlines.html> for the latest version.

SO-28 (Type TH)

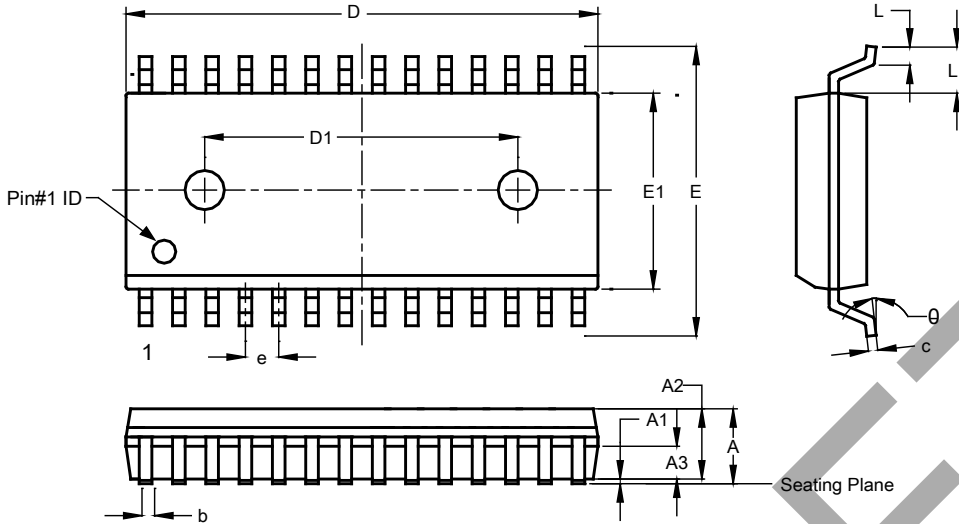

SO-28 (Type TH)			
Dim	Min	Max	Typ
A	--	2.65	--
A1	0.10	0.30	--
A2	2.25	2.35	2.30
A3	0.97	1.07	1.02
b	0.39	0.48	--
c	0.25	0.31	--
D	17.80	18.20	18.00
D1	11.90	12.10	12.00
E	10.10	10.50	10.30
E1	7.30	7.70	7.50
e	1.27 BSC		
L	0.70	1.00	--
L1	1.40 BSC		
θ	0°	8°	--
All Dimensions in mm			

Suggested Pad Layout

Please see <http://www.diodes.com/package-outlines.html> for the latest version.

SO-28 (Type TH)

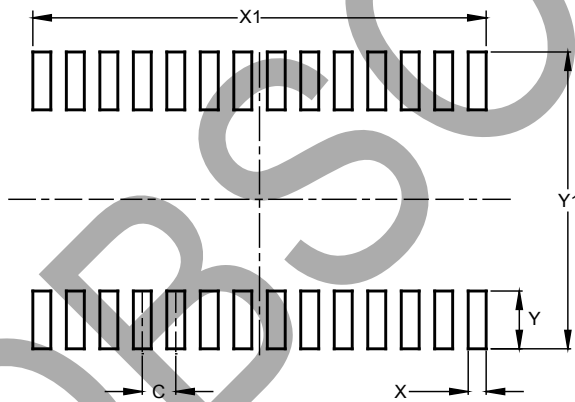

Dimensions	Value (in mm)
C	1.270
X	0.680
X1	17.190
Y	2.200
Y1	11.300

Note: For high-voltage applications, the appropriate industry sector guidelines should be considered with regards to creepage and clearance distances between device Terminals and PCB tracking.

OBSOLETE - PART DISCONTINUED

IMPORTANT NOTICE

1. DIODES INCORPORATED AND ITS SUBSIDIARIES (“DIODES”) MAKE NO WARRANTY OF ANY KIND, EXPRESS OR IMPLIED, WITH REGARDS TO ANY INFORMATION CONTAINED IN THIS DOCUMENT, INCLUDING, BUT NOT LIMITED TO, THE IMPLIED WARRANTIES OF MERCHANTABILITY, FITNESS FOR A PARTICULAR PURPOSE OR NON-INFRINGEMENT OF THIRD PARTY INTELLECTUAL PROPERTY RIGHTS (AND THEIR EQUIVALENTS UNDER THE LAWS OF ANY JURISDICTION).
2. The Information contained herein is for informational purpose only and is provided only to illustrate the operation of Diodes products described herein and application examples. Diodes does not assume any liability arising out of the application or use of this document or any product described herein. This document is intended for skilled and technically trained engineering customers and users who design with Diodes products. Diodes products may be used to facilitate safety-related applications; however, in all instances customers and users are responsible for (a) selecting the appropriate Diodes products for their applications, (b) evaluating the suitability of the Diodes products for their intended applications, (c) ensuring their applications, which incorporate Diodes products, comply the applicable legal and regulatory requirements as well as safety and functional-safety related standards, and (d) ensuring they design with appropriate safeguards (including testing, validation, quality control techniques, redundancy, malfunction prevention, and appropriate treatment for aging degradation) to minimize the risks associated with their applications.
3. Diodes assumes no liability for any application-related information, support, assistance or feedback that may be provided by Diodes from time to time. Any customer or user of this document or products described herein will assume all risks and liabilities associated with such use, and will hold Diodes and all companies whose products are represented herein or on Diodes’ websites, harmless against all damages and liabilities.
4. Products described herein may be covered by one or more United States, international or foreign patents and pending patent applications. Product names and markings noted herein may also be covered by one or more United States, international or foreign trademarks and trademark applications. Diodes does not convey any license under any of its intellectual property rights or the rights of any third parties (including third parties whose products and services may be described in this document or on Diodes’ website) under this document.
5. Diodes products are provided subject to Diodes’ Standard Terms and Conditions of Sale (<https://www.diodes.com/about/company/terms-and-conditions/terms-and-conditions-of-sales/>) or other applicable terms. This document does not alter or expand the applicable warranties provided by Diodes. Diodes does not warrant or accept any liability whatsoever in respect of any products purchased through unauthorized sales channel.
6. Diodes products and technology may not be used for or incorporated into any products or systems whose manufacture, use or sale is prohibited under any applicable laws and regulations. Should customers or users use Diodes products in contravention of any applicable laws or regulations, or for any unintended or unauthorized application, customers and users will (a) be solely responsible for any damages, losses or penalties arising in connection therewith or as a result thereof, and (b) indemnify and hold Diodes and its representatives and agents harmless against any and all claims, damages, expenses, and attorney fees arising out of, directly or indirectly, any claim relating to any noncompliance with the applicable laws and regulations, as well as any unintended or unauthorized application.
7. While efforts have been made to ensure the information contained in this document is accurate, complete and current, it may contain technical inaccuracies, omissions and typographical errors. Diodes does not warrant that information contained in this document is error-free and Diodes is under no obligation to update or otherwise correct this information. Notwithstanding the foregoing, Diodes reserves the right to make modifications, enhancements, improvements, corrections or other changes without further notice to this document and any product described herein. This document is written in English but may be translated into multiple languages for reference. Only the English version of this document is the final and determinative format released by Diodes.
8. Any unauthorized copying, modification, distribution, transmission, display or other use of this document (or any portion hereof) is prohibited. Diodes assumes no responsibility for any losses incurred by the customers or users or any third parties arising from any such unauthorized use.

Copyright © 2021 Diodes Incorporated

www.diodes.com