

## Description

The DGD2117 and DGD2118 are high-voltage/high-speed gate drivers capable of driving one n-channel MOSFET or IGBT in a bootstrap configuration. High-voltage processing techniques enable the DGD2117 and DGD2118 to switch at 600V.

The DGD2117 and DGD2118 logic inputs are compatible with standard CMOS outputs. The driver outputs feature high pulse current buffers designed for minimum driver cross conduction. The single floating channel can be used in high-side and low-side configuration.

The DGD2117 and DGD2118 are offered in SO-8 (Type TH) package and the operating temperature extends from -40°C to +125°C.

## Features

- Floating Channel in Bootstrap Operation to 600V
- Drives One N-Channel MOSFET or IGBT
- Outputs Tolerant to Negative Transients
- Wide Logic Supply: 10V to 20V
- Schmitt Triggered Logic Input with Internal Pulldown
- Undervoltage Lockout
- Extended Temperature Range: -40°C to +125°C
- **Totally Lead-Free & Fully RoHS Compliant (Notes 1 & 2)**
- **Halogen and Antimony Free. "Green" Device (Note 3)**
- **For automotive applications requiring specific change control (i.e. parts qualified to AEC-Q100/101/104/200, PPAP capable, and manufactured in IATF 16949 certified facilities), please [contact us](https://www.diodes.com/quality/product-definitions/) or your local Diodes representative.**  
<https://www.diodes.com/quality/product-definitions/>

## Applications

- DC-DC converters
- DC-AC inverters
- AC-DC power supplies
- Motor controls
- Class D power amplifiers

## Mechanical Data

- Package: SO-8
- Package Material: Molded Plastic. "Green" Molding Compound. UL Flammability Classification Rating 94V-0
- Moisture Sensitivity: Level 3 per J-STD-020
- Terminals: Finish – Matte Tin Plated Leads. Solderable per MIL-STD-202, Method 208, Ⓔ3
- Weight: 0.075 grams (Approximate)

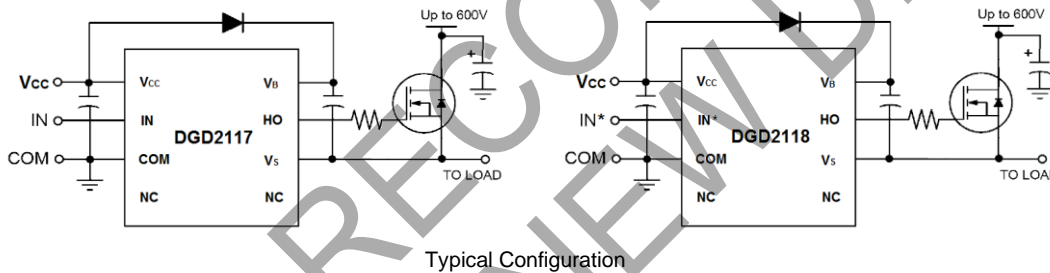

## Ordering Information (Note 4)

Part Number	Package	Marking	Reel Size (inches)	Tape Width (mm)	Packing	
					Qty.	Carrier
DGD2117S8-13	SO-8 (Type TH)	DGD2117	13	12	2,500	Reel
DGD2118S8-13	SO-8 (Type TH)	DGD2118	13	12	2,500	Reel

- Notes:
1. No purposely added lead. Fully EU Directive 2002/95/EC (RoHS), 2011/65/EU (RoHS 2) & 2015/863/EU (RoHS 3) compliant.
  2. See <https://www.diodes.com/quality/lead-free/> for more information about Diodes Incorporated's definitions of Halogen- and Antimony-free, "Green" and Lead-free.
  3. Halogen- and Antimony-free "Green" products are defined as those which contain <900ppm bromine, <900ppm chlorine (<1500ppm total Br + Cl) and <1000ppm antimony compounds.
  4. For packaging details, go to our website at <https://www.diodes.com/design/support/packaging/diodes-packaging/>.

## Marking Information

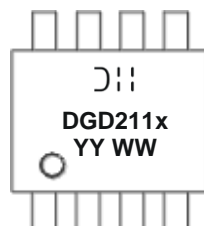

⏏ = Manufacturer's Marking  
 DGD211x = Product Type Marking Code (See Table Above)  
 YY = Year (ex: 24 = 2024)  
 WW = Week (01 to 53)

**Pin Diagrams**

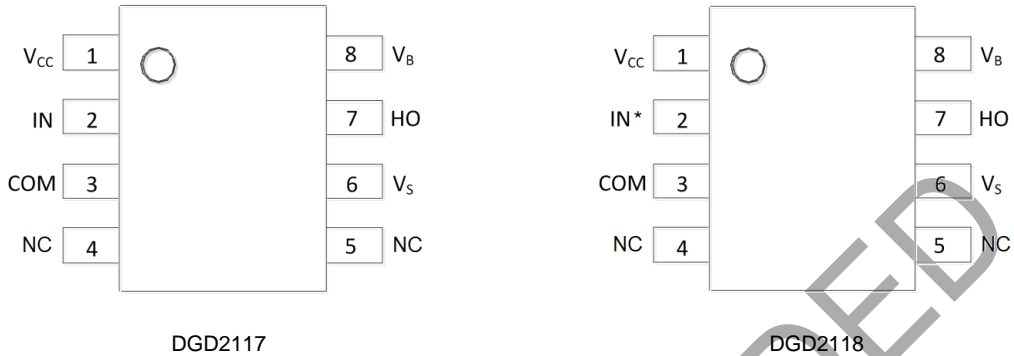

Top View SO-8 (Type TH)

**Pin Descriptions**

Pin Number	Pin Name	Function
1	V <sub>CC</sub>	Logic and gate driver supply
2	IN	DGD2117 Logic input for gate driver output (HO), in phase with HO
2	IN*	DGD2118 Logic input for gate driver output (HO), out of phase with HO
3	COM	Logic ground
4, 5	NC	No connection (No internal connection)
6	V <sub>S</sub>	High-side floating supply return
7	HO	High-side gate drive output
8	V <sub>B</sub>	High-side floating supply

**Functional Block Diagram**

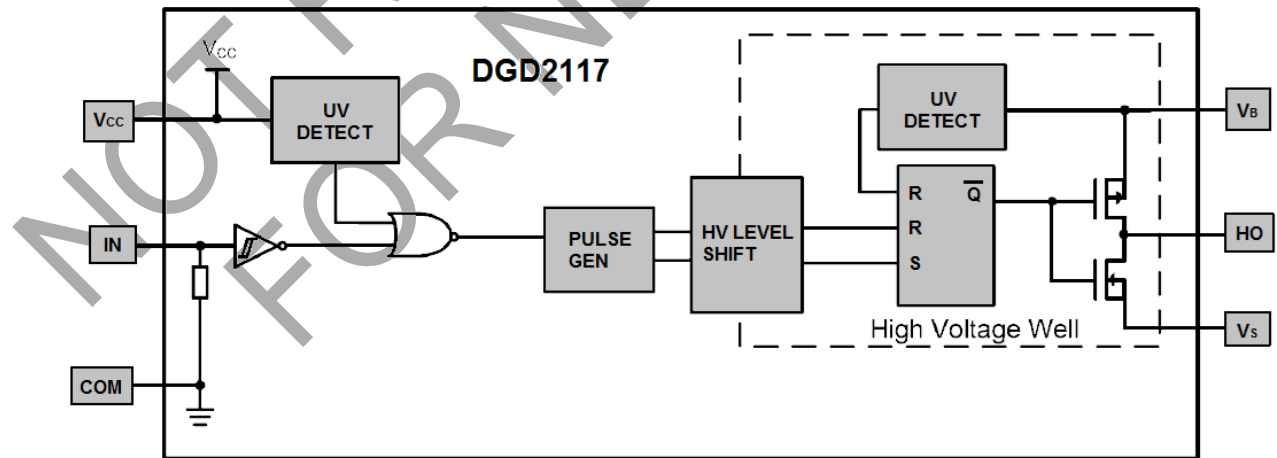

**Functional Block Diagram** (continued)

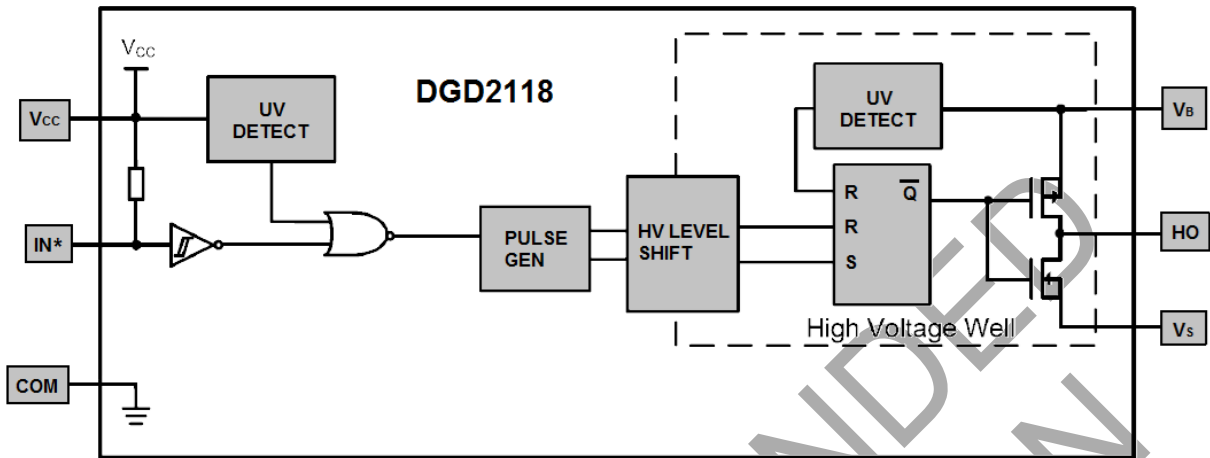

**Absolute Maximum Ratings** (@ $T_A = +25^\circ\text{C}$ , unless otherwise specified.)

Characteristic	Symbol	Value	Unit
High-Side Floating Supply Voltage	$V_B$	-0.3 to +624	V
High-Side Floating Supply Offset Voltage	$V_S$	$V_B - 24$ to $V_B + 0.3$	V
High-Side Floating Output Voltage	$V_{HO}$	$V_S - 0.3$ to $V_B + 0.3$	V
Logic Supply Voltage	$V_{CC}$	-0.3 to +24	V
Logic Input Voltage	$V_{IN}$	-0.3 to $V_{CC} + 0.3$	V
Allowable Offset Supply Voltage Transient	$dV_S / dt$	50	V/ns

**Thermal Characteristics** (@ $T_A = +25^\circ\text{C}$ , unless otherwise specified.)

Characteristic	Symbol	Value	Unit
Power Dissipation Linear Derating Factor (Note 5)	$P_D$	0.625	W
Thermal Resistance, Junction to Ambient (Note 5)	$R_{\theta JA}$	200	$^\circ\text{C}/\text{W}$
Thermal Resistance, Junction to Case (Note 6)	$R_{\theta JC}$	45	$^\circ\text{C}/\text{W}$
Operating Temperature	$T_J$	+150	$^\circ\text{C}$
Lead Temperature (Soldering, 10s)	$T_L$	+300	
Storage Temperature Range	$T_{STG}$	-55 to +150	

Note: 5. When mounted on a standard JEDEC 2-layer FR-4 board.

**Recommended Operating Conditions**

Parameter	Symbol	Min	Max	Unit
High Side Floating Supply Absolute Voltage	$V_B$	$V_S + 10$	$V_S + 20$	V
High Side Floating Supply Offset Voltage	$V_S$	(Note 6)	600	V
High Side Floating Output Voltage	$V_{HO}$	$V_S$	$V_B$	V
Low Side and Logic Fixed Supply Voltage	$V_{CC}$	10	20	V
Logic Input Voltage	$V_{IN}$	0	$V_{CC}$	V
Ambient Temperature	$T_A$	-40	+125	$^\circ\text{C}$

Note: 6. Logic operation for  $V_S = -5\text{V}$  to +600V.

**DC Electrical Characteristics** ( $V_{BIAS} (V_{CC}, V_{BS}) = 15V, @T_A = +25^\circ C$ , unless otherwise specified.) (Note 7)

Parameter	Symbol	Min	Typ	Max	Unit	Conditions	
Logic "1" (DGD2117) & Logic "0" (DGD2118) Input Voltage (Note 8)	$V_{IH}$	9.5	—	—	V	—	
Logic "0" (DGD2117) & Logic "1" (DGD2118) Input Voltage (Note 8)	$V_{IL}$	—	—	6.0	V	—	
High-Level Output Voltage, $V_{BIAS} - V_O$	$V_{OH}$	—	0.05	0.2	V	$I_O = 2mA$	
Low-Level Output Voltage, $V_O$	$V_{OL}$	—	0.02	0.1	V	$I_O = 2mA$	
Offset Supply Leakage Current	$I_{LK}$	—	—	50	$\mu A$	$V_B = V_S = 600V$	
Quiescent $V_{BS}$ Supply Current	$I_{BSQ}$	—	50	240	$\mu A$	$V_{IN} = 0V$ or $V_{CC}$	
Quiescent $V_{CC}$ Supply Current	$I_{CCQ}$	—	70	340	$\mu A$	$V_{IN} = 0V$ or $V_{CC}$	
Logic "1" Input Bias Current	DGD2117	$I_{IN+}$	—	20	40	$\mu A$	$V_{IN} = V_{CC}$
	DGD2118						$V_{IN} = 0V$
Logic "0" Input Bias Current	DGD2117	$I_{IN-}$	—	—	5.0	$\mu A$	$V_{IN} = 0V$
	DGD2118						$V_{IN} = V_{CC}$
$V_{BS}$ Supply Undervoltage Positive Going Threshold	$V_{BSUV+}$	7.6	8.6	9.6	V	—	
$V_{BS}$ Supply Undervoltage Negative Going Threshold	$V_{BSUV-}$	7.2	8.2	9.2	V	—	
$V_{CC}$ Supply Undervoltage Positive Going Threshold	$V_{CCUV+}$	7.6	8.6	9.6	V	—	
$V_{CC}$ Supply Undervoltage Negative Going Threshold	$V_{CCUV-}$	7.2	8.2	9.2	V	—	
Output High Short-Circuit Pulsed Current	$I_{O+}$	200	290	—	mA	$V_O = 0V, V_{IN} = \text{Logic "1"}$ $P_W \leq 10\mu s$	
Output Low Short-Circuit Pulsed Current	$I_{O-}$	420	600	—	mA	$V_O = 15V, V_{IN} = \text{Logic "0"}$ $P_W \leq 10\mu s$	

- Notes:
- The  $V_{IN}$  and  $I_{IN}$  parameters are referenced to COM and are applicable to the logic input pins: IN and IN\*. The  $V_O$  and  $I_O$  parameters are referenced to COM and are applicable to the output pin: HO.
  - For optimal operation, it is recommended that the input pulses (IN and IN\*) should have a minimum amplitude of 9.5V with a minimum pulse width of 250ns.

**AC Electrical Characteristics** ( $V_{BIAS} (V_{CC}, V_{BS}) = 15V, C_L = 1000pF, @T_A = +25^\circ C$ , unless otherwise specified.)

Parameter	Symbol	Min	Typ	Max	Unit	Conditions
Turn-On Propagation Delay	$t_{ON}$	—	125	200	ns	$V_S = 0V$
Turn-Off Propagation Delay	$t_{OFF}$	—	105	180	ns	$V_S = 600V$
Turn-On Rise Time	$t_r$	—	75	130	ns	—
Turn-Off Fall Time	$t_f$	—	35	65	ns	—

**Timing Waveforms**

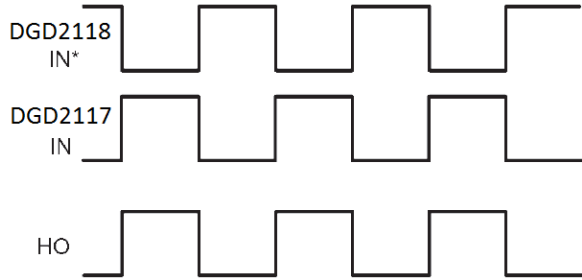

**Figure 1.** Input / Output Timing Diagram

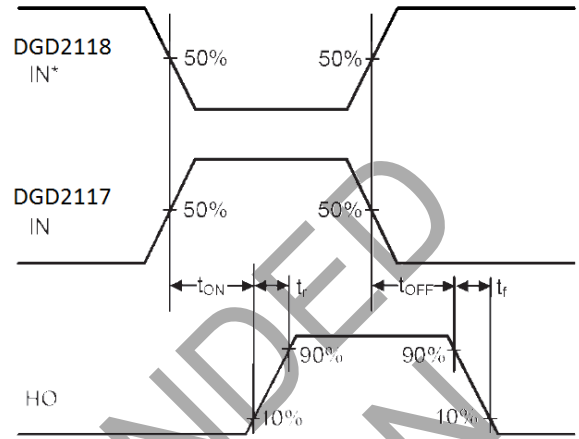

**Figure 2.** Switching Time Waveform Definitions

NOT RECOMMENDED FOR NEW DESIGN

**Typical Performance Characteristics** ( $V_{CC} = 15V$ ,  $@T_A = +25^\circ C$ , unless otherwise specified.)

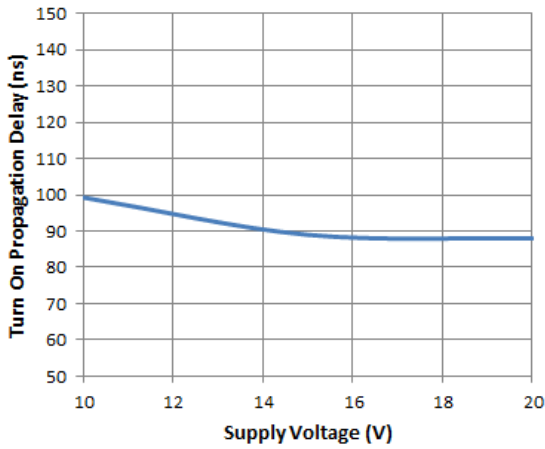

**Figure 3.** Turn-on Propagation Delay vs. Supply Voltage

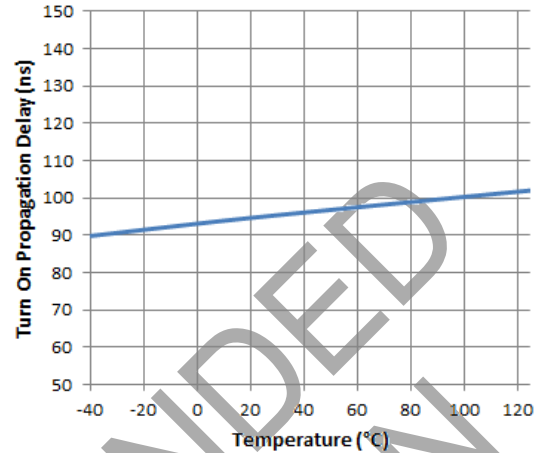

**Figure 4.** Turn-on Propagation Delay vs. Temperature

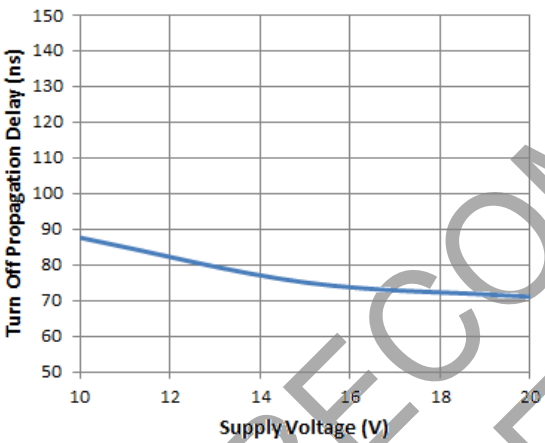

**Figure 5.** Turn-off Propagation Delay vs. Supply Voltage

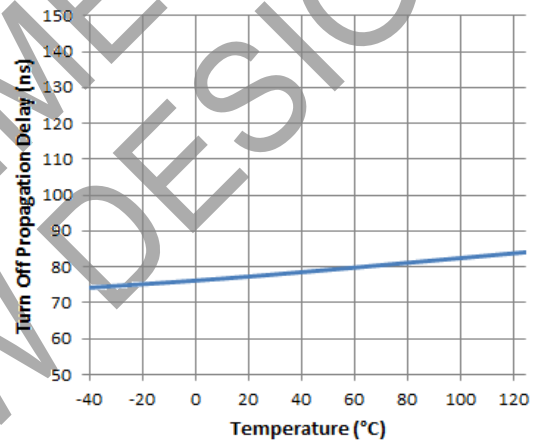

**Figure 6.** Turn-off Propagation Delay vs. Temperature

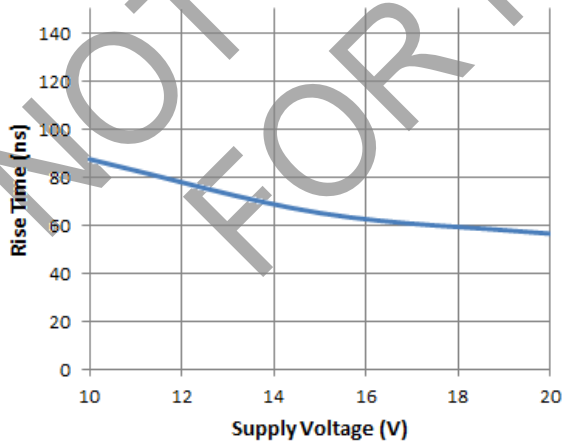

**Figure 7.** Rise Time vs. Supply Voltage

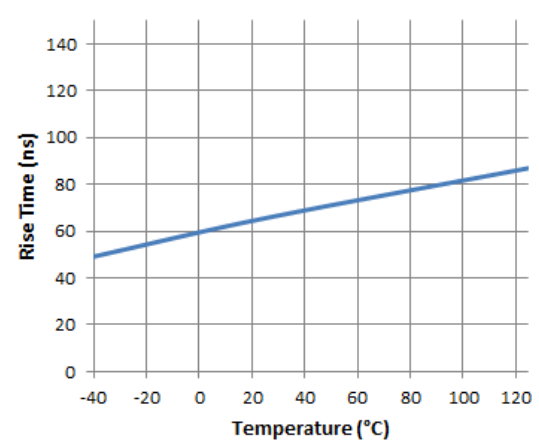

**Figure 8.** Rise Time vs. Temperature

**Typical Performance Characteristics** ( $V_{CC} = 15V$ ,  $@T_A = +25^\circ C$ , unless otherwise specified.) (continued)

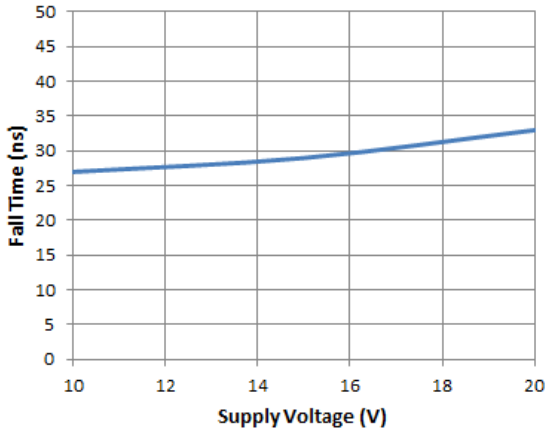

Figure 9. Fall Time vs. Supply Voltage

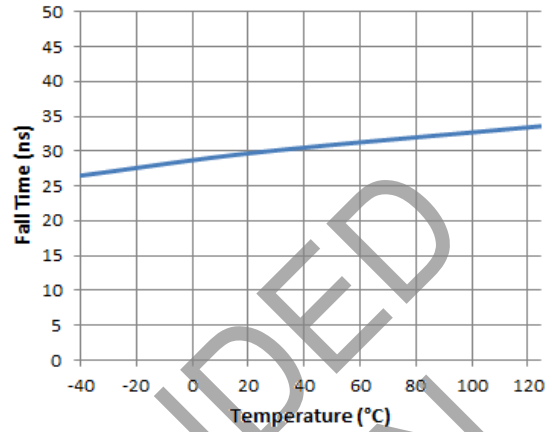

Figure 10. Fall Time vs. Temperature

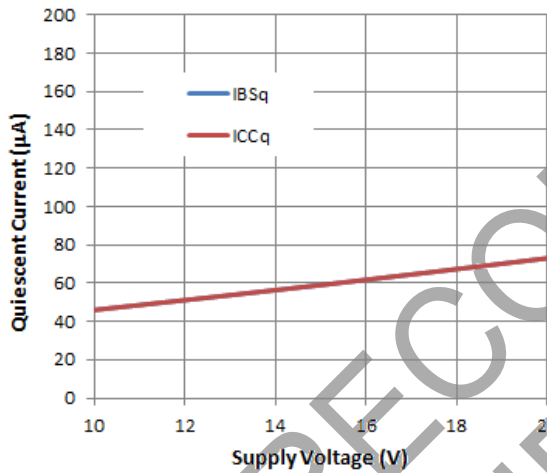

Figure 11. Quiescent Current vs. Supply Voltage

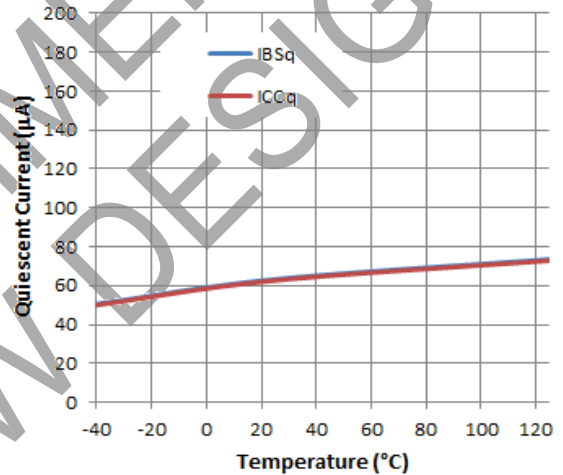

Figure 12. Quiescent Current vs. Temperature

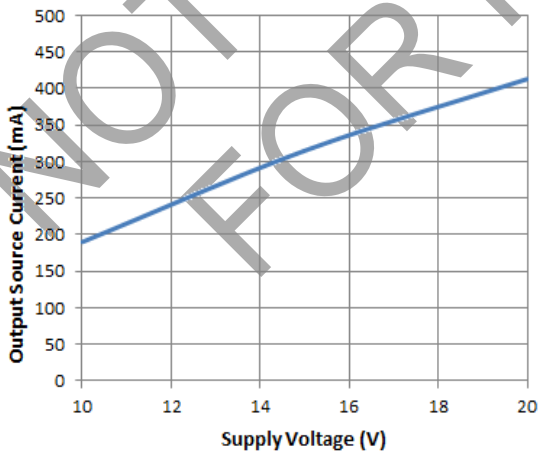

Figure 13. Output Source Current vs. Supply Voltage

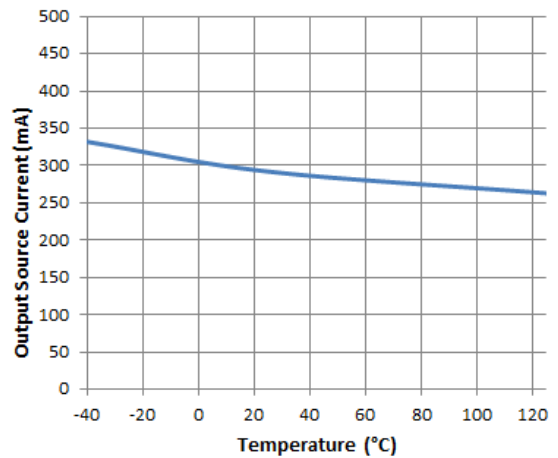
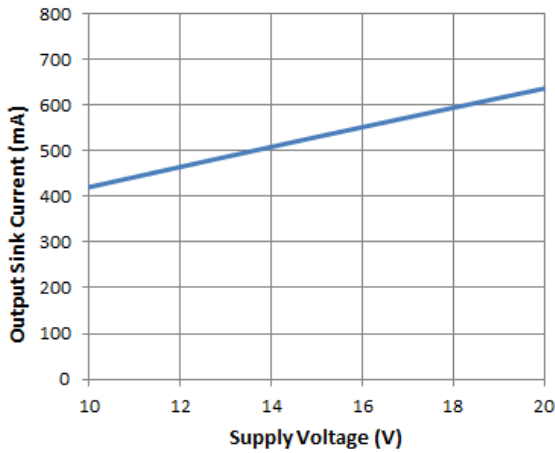
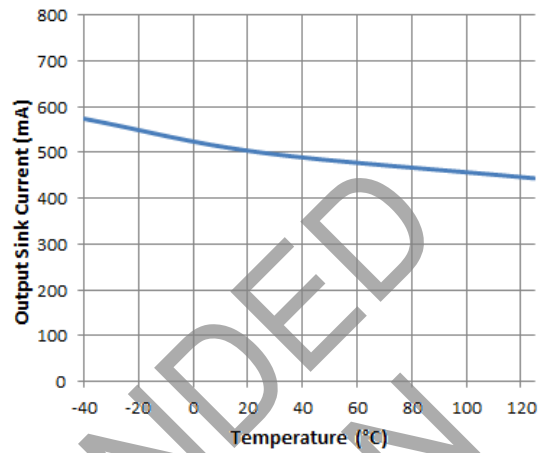

Figure 14. Output Source Current vs. Temperature

**Typical Performance Characteristics** ( $V_{CC} = 15V$ ,  $@T_A = +25^\circ C$ , unless otherwise specified.) (continued)



**Figure 15.** Output Sink Current vs. Supply Voltage



**Figure 16.** Output Sink Current vs. Temperature

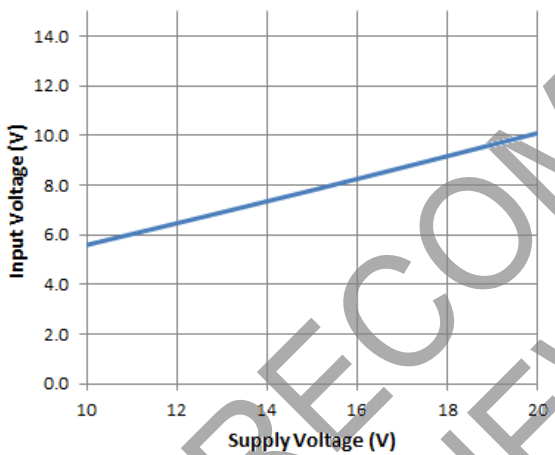

**Figure 17.** DGD2117 Logic 1 (DGD2118 Logic 0) Input Voltage vs. Supply Voltage

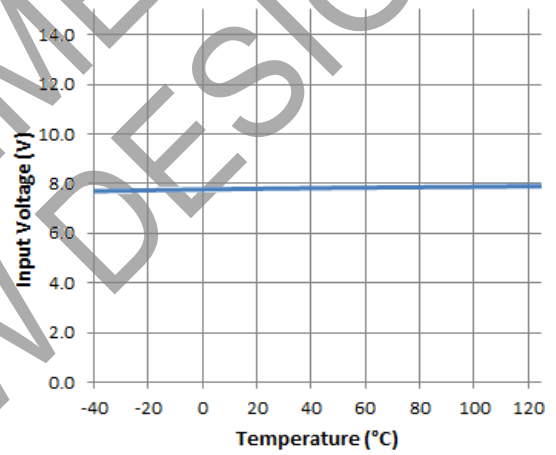

**Figure 18.** DGD2117 Logic 1 (DGD2118 Logic 0) Input Voltage vs. Temperature

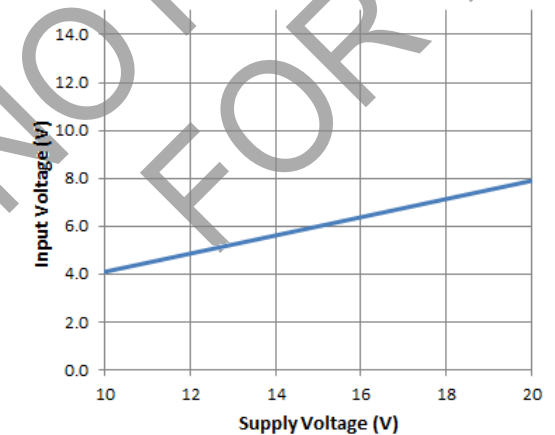

**Figure 19.** DGD2117 Logic 0 (DGD2118 Logic 1) Input Voltage vs. Supply Voltage

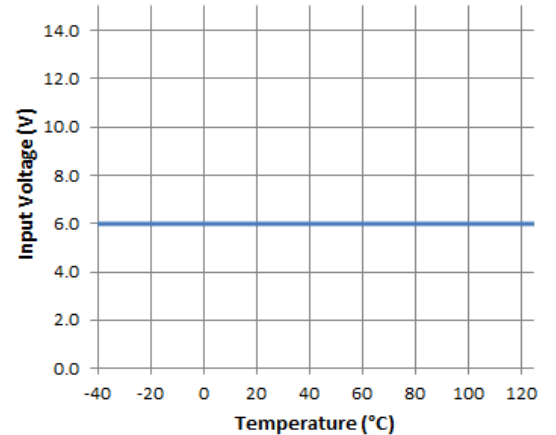

**Figure 20.** DGD2117 Logic 0 (DGD2118 Logic 1) Input Voltage vs. Temperature



**Typical Performance Characteristics** ( $V_{CC} = 15V$ ,  $@T_A = +25^\circ C$ , unless otherwise specified.) (continued)

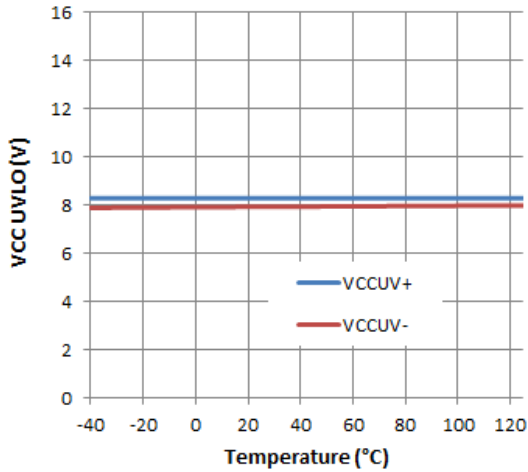

Figure 21. VCC UVLO vs. Temperature

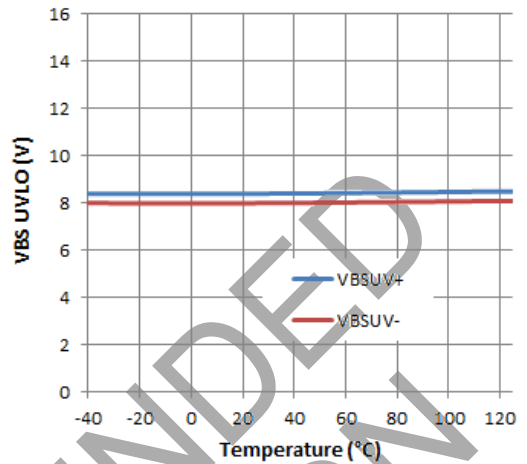

Figure 22. VBS UVLO vs. Temperature

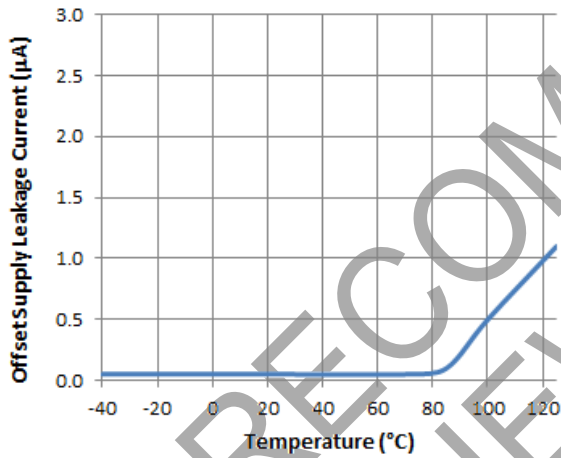

Figure 23. Offset Supply Leakage Current vs. Temperature

NOT RECOMMENDED FOR NEW DESIGN

**Package Outline Dimensions**

Please see <http://www.diodes.com/package-outlines.html> for the latest version.

**SO-8 (Type TH)**

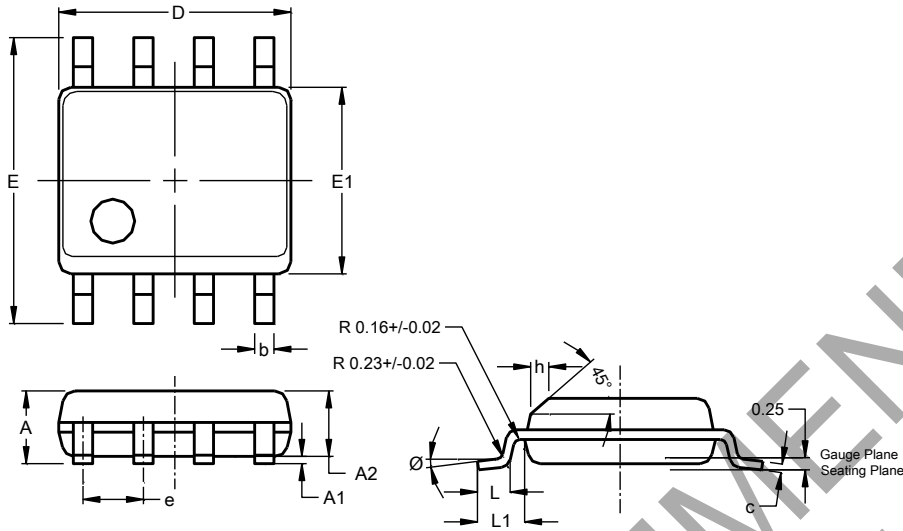

SO-8 (Type TH)			
Dim	Min	Max	Typ
A	1.35	1.75	--
A1	0.10	0.25	--
A2	--	--	1.45
b	0.35	0.51	--
c	0.190	0.248	--
D	4.80	5.00	4.90
E	5.80	6.20	6.00
E1	3.80	4.00	3.90
e	--	--	1.27
h	0.25	0.50	--
L	0.41	1.27	--
L1	--	--	1.04
Ø	0°	8°	--
All Dimensions in mm			

**Suggested Pad Layout**

Please see <http://www.diodes.com/package-outlines.html> for the latest version.

**SO-8 (Type TH)**

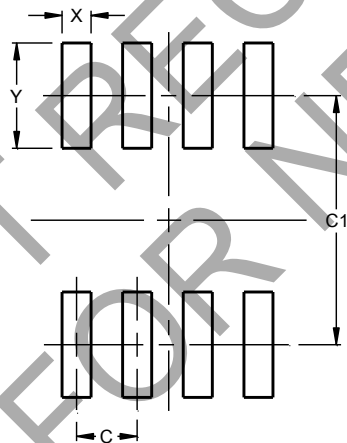

Dimensions	Value (in mm)
C	1.27
C1	5.20
X	0.60
Y	2.20

Note: 9. For high voltage applications, the appropriate industry sector guidelines should be considered with regards to creepage and clearance distances between device Terminals and PCB tracking.

**IMPORTANT NOTICE**

1. DIODES INCORPORATED (Diodes) AND ITS SUBSIDIARIES MAKE NO WARRANTY OF ANY KIND, EXPRESS OR IMPLIED, WITH REGARDS TO ANY INFORMATION CONTAINED IN THIS DOCUMENT, INCLUDING, BUT NOT LIMITED TO, THE IMPLIED WARRANTIES OF MERCHANTABILITY, FITNESS FOR A PARTICULAR PURPOSE OR NON-INFRINGEMENT OF THIRD PARTY INTELLECTUAL PROPERTY RIGHTS (AND THEIR EQUIVALENTS UNDER THE LAWS OF ANY JURISDICTION).
2. The Information contained herein is for informational purpose only and is provided only to illustrate the operation of Diodes' products described herein and application examples. Diodes does not assume any liability arising out of the application or use of this document or any product described herein. This document is intended for skilled and technically trained engineering customers and users who design with Diodes' products. Diodes' products may be used to facilitate safety-related applications; however, in all instances customers and users are responsible for (a) selecting the appropriate Diodes products for their applications, (b) evaluating the suitability of Diodes' products for their intended applications, (c) ensuring their applications, which incorporate Diodes' products, comply the applicable legal and regulatory requirements as well as safety and functional-safety related standards, and (d) ensuring they design with appropriate safeguards (including testing, validation, quality control techniques, redundancy, malfunction prevention, and appropriate treatment for aging degradation) to minimize the risks associated with their applications.
3. Diodes assumes no liability for any application-related information, support, assistance or feedback that may be provided by Diodes from time to time. Any customer or user of this document or products described herein will assume all risks and liabilities associated with such use, and will hold Diodes and all companies whose products are represented herein or on Diodes' websites, harmless against all damages and liabilities.
4. Products described herein may be covered by one or more United States, international or foreign patents and pending patent applications. Product names and markings noted herein may also be covered by one or more United States, international or foreign trademarks and trademark applications. Diodes does not convey any license under any of its intellectual property rights or the rights of any third parties (including third parties whose products and services may be described in this document or on Diodes' website) under this document.
5. Diodes' products are provided subject to Diodes' Standard Terms and Conditions of Sale (<https://www.diodes.com/about/company/terms-and-conditions/terms-and-conditions-of-sales/>) or other applicable terms. This document does not alter or expand the applicable warranties provided by Diodes. Diodes does not warrant or accept any liability whatsoever in respect of any products purchased through unauthorized sales channel.
6. Diodes' products and technology may not be used for or incorporated into any products or systems whose manufacture, use or sale is prohibited under any applicable laws and regulations. Should customers or users use Diodes' products in contravention of any applicable laws or regulations, or for any unintended or unauthorized application, customers and users will (a) be solely responsible for any damages, losses or penalties arising in connection therewith or as a result thereof, and (b) indemnify and hold Diodes and its representatives and agents harmless against any and all claims, damages, expenses, and attorney fees arising out of, directly or indirectly, any claim relating to any noncompliance with the applicable laws and regulations, as well as any unintended or unauthorized application.
7. While efforts have been made to ensure the information contained in this document is accurate, complete and current, it may contain technical inaccuracies, omissions and typographical errors. Diodes does not warrant that information contained in this document is error-free and Diodes is under no obligation to update or otherwise correct this information. Notwithstanding the foregoing, Diodes reserves the right to make modifications, enhancements, improvements, corrections or other changes without further notice to this document and any product described herein. This document is written in English but may be translated into multiple languages for reference. Only the English version of this document is the final and determinative format released by Diodes.
8. Any unauthorized copying, modification, distribution, transmission, display or other use of this document (or any portion hereof) is prohibited. Diodes assumes no responsibility for any losses incurred by the customers or users or any third parties arising from any such unauthorized use.
9. This Notice may be periodically updated with the most recent version available at <https://www.diodes.com/about/company/terms-and-conditions/important-notice>

The Diodes logo is a registered trademark of Diodes Incorporated in the United States and other countries.  
All other trademarks are the property of their respective owners.  
© 2024 Diodes Incorporated. All Rights Reserved.

[www.diodes.com](http://www.diodes.com)