

Description

The DGD21844M is a high-voltage and high-speed gate driver capable of driving N-Channel MOSFETs and IGBTs in a half-bridge configuration. High-voltage processing techniques enable the DGD21844M's high-side to switch to 600V in a bootstrap operation.

The DGD21844M logic inputs are compatible with standard TTL and CMOS levels (down to 3.3V) for easy interfacing with controlling devices. The driver outputs feature high-pulse current buffers designed for minimum driver cross conduction. Programmable deadtime by an external resistor provides more system level flexibility.

The DGD21844M is offered in the SO-14 (Type TH) package and the device's operating temperature extends from -40°C to +125°C.

Applications

- DC-DC converters
- DC-AC inverters
- AC-DC power supplies
- Motor controls
- Class-D power amplifiers

Features

- Floating High-Side Driver in Bootstrap Operation to 600V
- Drives Two N-Channel MOSFETs or IGBTs in Half Bridge Configuration
- 1.9A Source / 2.3A Sink Output Current Capability
- Outputs Tolerant to Negative Transients
- Programmable Deadtime to Protect MOSFETs
- Wide Low-Side Gate Driver and Logic Supply: 10V to 20V
- Wide Logic Supply Voltage Offset Voltage: -5V to 5V
- Logic Input (IN and SD*) 3.3V Capability
- Schmitt Triggered Logic Inputs with Internal Pull Down
- Undervoltage Lockout for High- and Low-Side Drivers
- Extended Temperature Range: -40°C to +125°C
- **Totally Lead-Free & Fully RoHS Compliant (Notes 1 & 2)**
- **Halogen and Antimony free. "Green" Device (Note 3)**
- **For automotive applications requiring specific change control (i.e. parts qualified to AEC-Q100/101/104/200, PPAP capable, and manufactured in IATF 16949 certified facilities), please [contact us](https://www.diodes.com/quality/product-definitions/) or your local Diodes representative.**

Mechanical Data

- Package: SO-14 (Type TH)
- Package Material: Molded Plastic. "Green" Molding Compound. UL Flammability Classification Rating 94V-0
- Moisture Sensitivity: Level 3 per J-STD-020
- Terminals: Finish – Matte Tin Plated Leads, Solderable per MIL-STD-202, Method 208 (E3)
- Weight: 0.142 grams (Approximate)

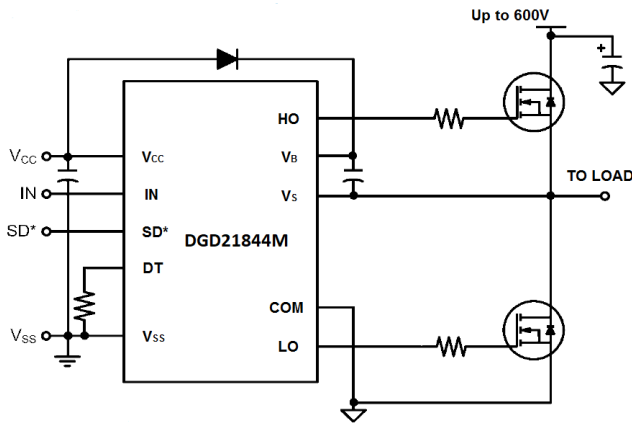

Typical Configuration



Top View

Ordering Information (Note 4)

Orderable Part Number	Package	Marking	Reel Size (inches)	Tape Width (mm)	Packing	
					Qty.	Carrier
DGD21844MS14-13	SO-14 (Type TH)	DGD21844M	13	16	2,500	Reel

- Notes:
1. No purposely added lead. Fully EU Directive 2002/95/EC (RoHS), 2011/65/EU (RoHS 2) & 2015/863/EU (RoHS 3) compliant.
 2. See <https://www.diodes.com/quality/lead-free/> for more information about Diodes Incorporated's definitions of Halogen- and Antimony-free, "Green" and Lead-free.
 3. Halogen- and Antimony-free "Green" products are defined as those which contain <900ppm bromine, <900ppm chlorine (<1500ppm total Br + Cl) and <1000ppm antimony compounds.
 4. For packaging details, go to our website at <https://www.diodes.com/design/support/packaging/diodes-packaging/>.

Marking Information

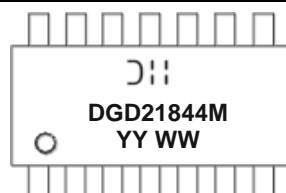

Di = Manufacturer's Marking
DGD21844M = Product Type Marking Code
YY = Year (ex: 23 = 2023)
WW = Week (01 to 53)

Pin Diagrams

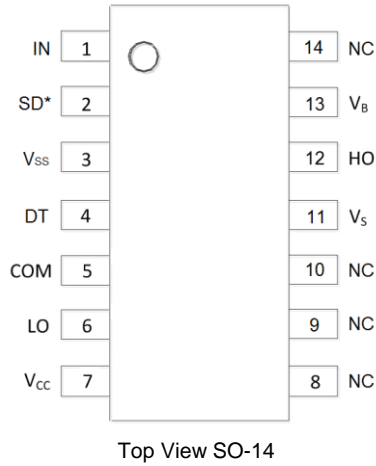

Pin Descriptions

Pin Number	Pin Name	Function
1	IN	Logic input for high-side and low-side gate driver outputs (HO and LO), in phase with HO (referenced to V _{SS})
2	SD*	Logic input for shutdown (referenced to V _{SS}), enabled low
3	V _{SS}	Logic ground
4	DT	Programmable Deadtime lead, referenced to V _{SS}
5	COM	Low-side return
6	LO	Low-side gate drive output
7	V _{CC}	Low-side and logic fixed supply
8, 9, 10, 14	NC	No connection (no internal connection)
11	V _S	High-side floating supply return
12	HO	High-side gate drive output
13	V _B	High-side floating supply

Functional Block Diagram

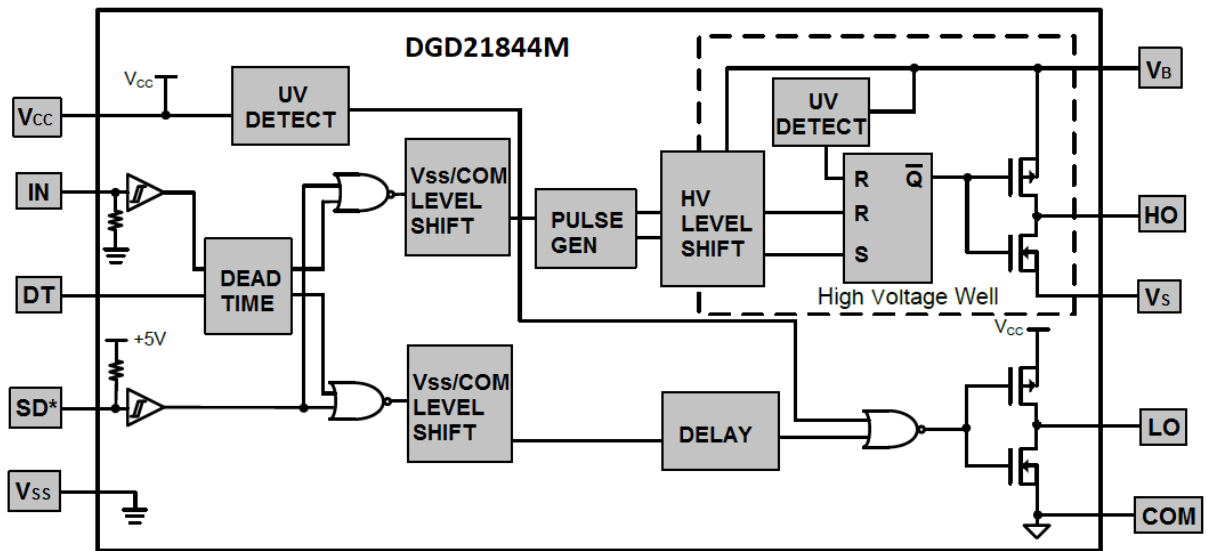

Absolute Maximum Ratings (@T_A = +25°C, unless otherwise specified.)

Characteristic	Symbol	Value	Unit
High-Side Floating Supply Voltage	V _B	-0.3 to +624	V
High-Side Floating Supply Offset Voltage	V _S	V _B -24 to V _B +0.3	V
High-Side Floating Output Voltage	V _{HO}	V _S -0.3 to V _B +0.3	V
Offset Supply Voltage Transient	dV _S / dt	50	V/ns
Programmable Dead Time Pin Voltage	V _{DT}	V _{SS} -0.3 to V _{CC} +0.3	V
Logic and Low-Side Fixed Supply Voltage	V _{CC}	-0.3 to +24	V
Low-Side Output Voltage	V _{LO}	-0.3 to V _{CC} +0.3	V
Logic Supply Offset Voltage	V _{SS}	V _{CC} -24 to V _{CC} +0.3	V
Logic Input Voltage (IN and SD*)	V _{IN}	V _{SS} -0.3 to V _{CC} +0.3	V

Thermal Characteristics (@T_A = +25°C, unless otherwise specified.)

Characteristic	Symbol	Value	Unit
Power Dissipation Linear Derating Factor (Note 5)	P _D	1.0	W
Thermal Resistance, Junction to Ambient (Note 5)	R _{θJA}	120	°C/W
Operating Temperature	T _J	+150	°C
Lead Temperature (Soldering, 10s)	T _L	+300	
Storage Temperature Range	T _{STG}	-55 to +150	

Note: 5. When mounted on a standard JEDEC 2-layer FR-4 board.

Recommended Operating Conditions

Parameter	Symbol	Min	Max	Unit
High Side Floating Supply Absolute Voltage	V _B	V _S + 10	V _S + 20	V
High Side Floating Supply Offset Voltage	V _S	(Note 6)	600	V
High Side Floating Output Voltage	V _{HO}	V _S	V _B	V
Logic and Low Side Fixed Supply Voltage	V _{CC}	10	20	V
Low Side Output Voltage	V _{LO}	0	V _{CC}	V
Logic Input Voltage (IN and SD*)	V _{IN}	V _{SS}	5	V
Programmable Dead Time Pin Voltage	V _{DT}	V _{SS}	V _{CC}	V
Logic Ground	V _{SS}	-5	5	V
Ambient Temperature	T _A	-40	+125	°C

Note: 6. Logic operation for V_S = -5V to +600V.

DC Electrical Characteristics ($V_{BIAS} (V_{CC}, V_{BS}) = 15V, V_{SS} = COM, @T_A = +25^\circ C$, unless otherwise specified.) (Note 7)

Parameter	Symbol	Min	Typ	Max	Unit	Conditions
Logic "1" Input Voltage for HO & Logic "0" for LO	V_{IH}	2.5	—	—	V	$V_{CC} = 10V$ to $20V$
Logic "0" Input Voltage for HO & Logic "1" for LO	V_{IL}	—	—	0.8	V	$V_{CC} = 10V$ to $20V$
SD* Input Positive Going Threshold	V_{SDTH+}	2.5	—	—	V	$V_{CC} = 10V$ to $20V$
SD* Input Negative Going Threshold	V_{SDTH-}	—	—	0.8	V	$V_{CC} = 10V$ to $20V$
High Level Output Voltage, $V_{BIAS} - V_O$	V_{OH}	—	—	1.4	V	$I_O = 0mA$
Low Level Output Voltage, V_O	V_{OL}	—	—	0.2	V	$I_O = 20mA$
Offset Supply Leakage Current	I_{LK}	—	—	50	μA	$V_B = V_S = 600V$
Quiescent V_{BS} Supply Current	I_{BSQ}	20	60	150	μA	$V_{IN} = 0V$ or $5V$
Quiescent V_{CC} Supply Current	I_{CCQ}	0.4	1.0	1.8	mA	$V_{IN} = 0V$ or $5V$
Logic "1" Input Bias Current	I_{IN+}	—	25	60	μA	$IN = 5V, SD^* = 0V$
Logic "0" Input Bias Current	I_{IN-}	—	—	1.0	μA	$IN = 0V, SD^* = 5V$
V_{BS} Supply Undervoltage Positive Going Threshold	V_{BSUV+}	8.0	8.9	9.8	V	—
V_{BS} Supply Undervoltage Negative Going Threshold	V_{BSUV-}	7.4	8.2	9.0	V	—
V_{CC} Supply Undervoltage Positive Going Threshold	V_{CCUV+}	8.0	8.9	9.8	V	—
V_{CC} Supply Undervoltage Negative Going Threshold	V_{CCUV-}	7.4	8.2	9.0	V	—
Output-High Short-Circuit Pulsed Current	I_{O+}	1.4	1.9	—	A	$V_O = 0V, PW \leq 10\mu s$
Output-Low Short-Circuit Pulsed Current	I_{O-}	1.7	2.3	—	A	$V_O = 15V, PW \leq 10\mu s$

Note: 7. The V_{IN} and I_{IN} parameters are referenced to V_{SS} and are applicable to the two logic input pins: IN and SD*. The V_O and I_O parameters are referenced to COM and are applicable to the respective output pins: HO and LO.

AC Electrical Characteristics ($V_{BIAS} (V_{CC}, V_{BS}) = 15V, V_{SS} = COM, C_L = 1000pF, @T_A = +25^\circ C$, unless otherwise specified.)

Parameter	Symbol	Min	Typ	Max	Unit	Conditions
Turn-On Propagation Delay	t_{ON}	—	585	900	ns	$V_S = 0V$
Turn-Off Propagation Delay	t_{OFF}	—	170	400	ns	$V_S = 0V$ or $600V$
Shut-Down Propagation Delay	t_{SD}	—	180	270	ns	—
Delay Matching, HO & LO Turn-On	t_{DMON}	—	—	90	ns	—
Delay Matching, HO & LO Turn-Off	t_{DMOFF}	—	—	40	ns	—
Turn-On Rise Time	t_R	—	40	60	ns	$V_S = 0V$
Turn-Off Fall Time	t_F	—	20	35	ns	$V_S = 0V$
Deadtime: $t_{DT LO-HO}$ & $t_{DT HO-LO}$	t_{DT}	280	400	520	ns	$R_{DT} = 0\Omega$
		4	5	6	μs	$R_{DT} = 200k\Omega$
Deadtime Matching = $t_{DT LO-HO} - t_{DT HO-LO}$	t_{MDT}	—	0	50	ns	$R_{DT} = 0\Omega$
		—	0	600	ns	$R_{DT} = 200k\Omega$

Timing Waveforms

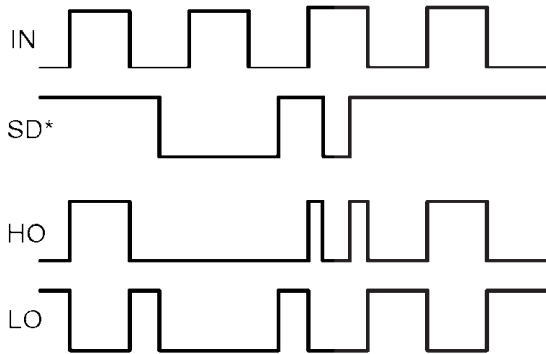

Figure 1. Input / Output Timing Diagram

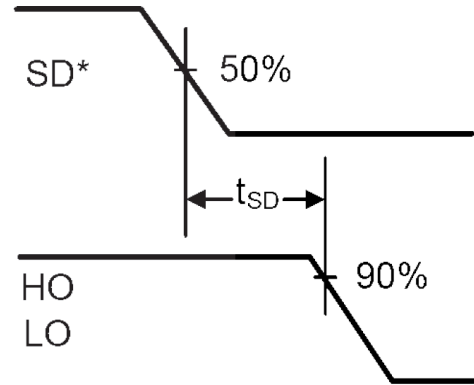
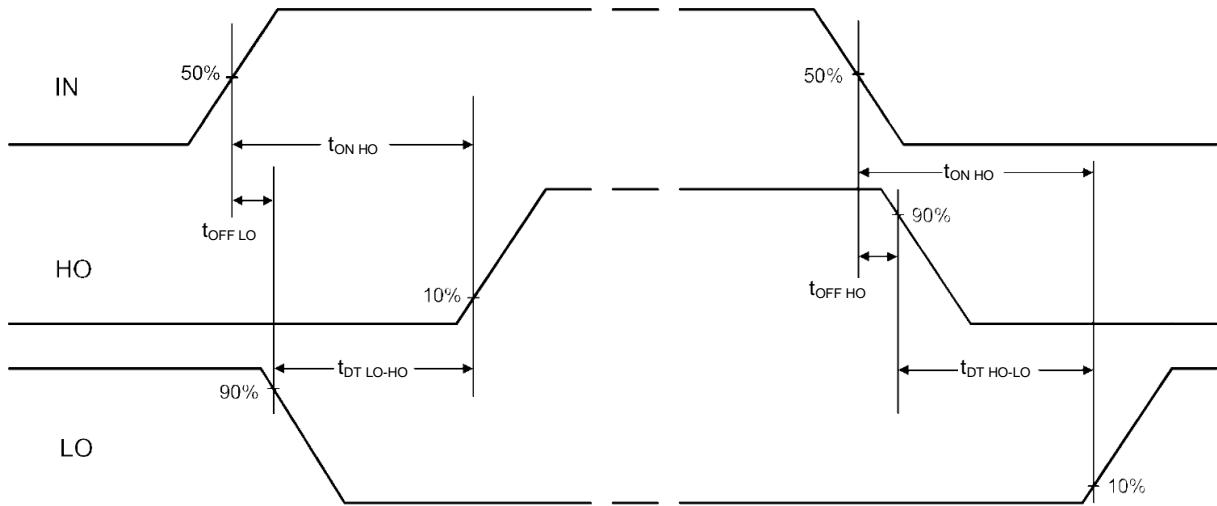

Figure 2. Shutdown Waveform Definitions



$t_{DT\ LO-HO} = t_{ON\ HO} - t_{OFF\ LO}$
 $t_{DT\ HO-LO} = t_{ON\ LO} - t_{OFF\ HO}$
 Deadtime matching
 $t_{MDT} = t_{DT\ LO-HO} - t_{DT\ HO-LO}$

Delay matching
 $t_{DM\ OFF} = t_{OFF\ LO} - t_{OFF\ HO}$

Figure 3. Switching Time Waveform Definitions

Typical Performance Characteristics ($V_{CC} = 15V$, $@T_A = +25^\circ C$, unless otherwise specified.)

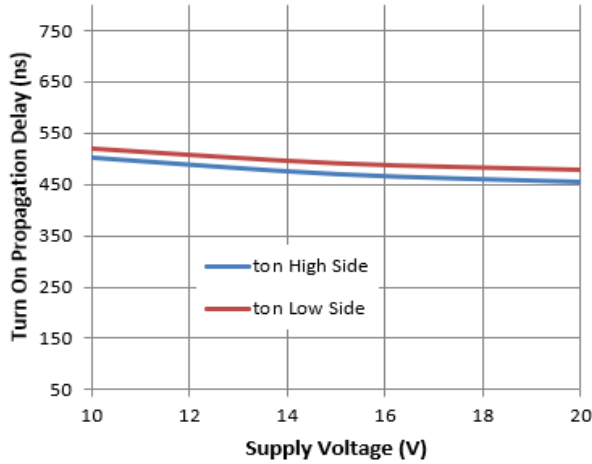

Figure 4. Turn-on Propagation Delay vs. Supply Voltage

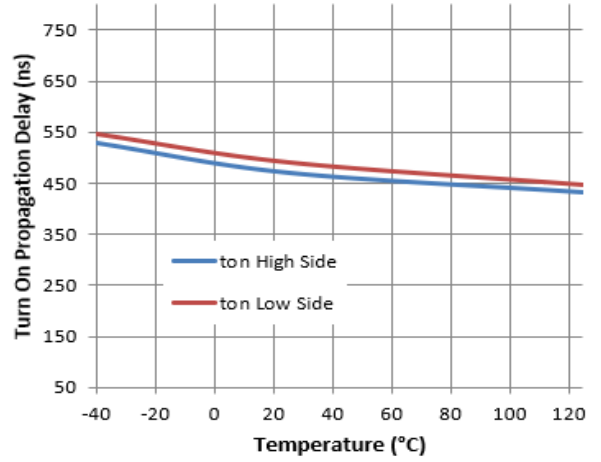

Figure 5. Turn-on Propagation Delay vs. Temperature

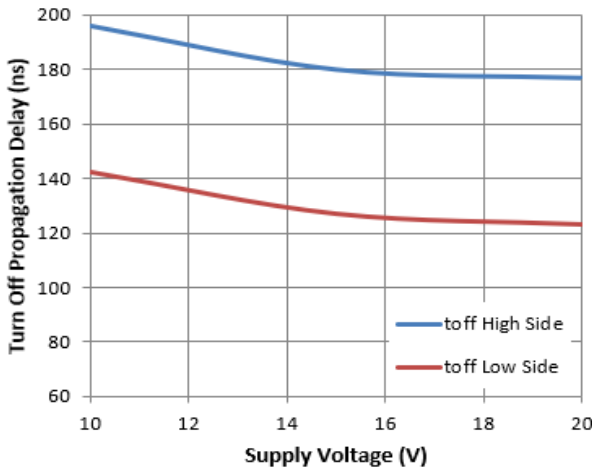

Figure 6. Turn-off Propagation Delay vs. Supply Voltage

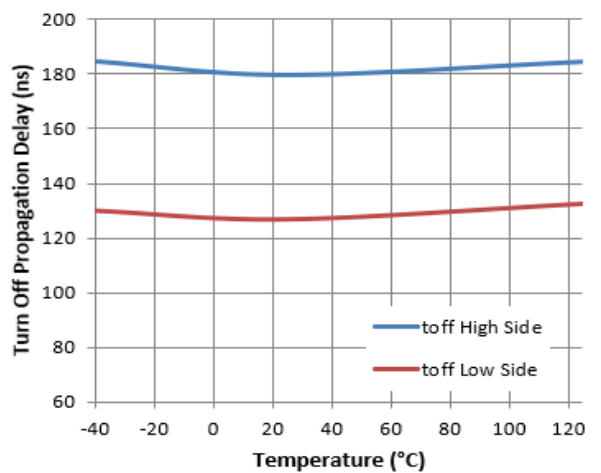

Figure 7. Turn-off Propagation Delay vs. Temperature

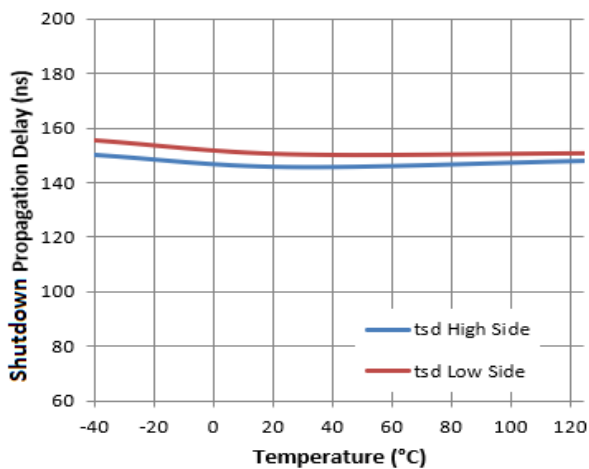

Figure 8. SD Propagation Delay vs. Temperature

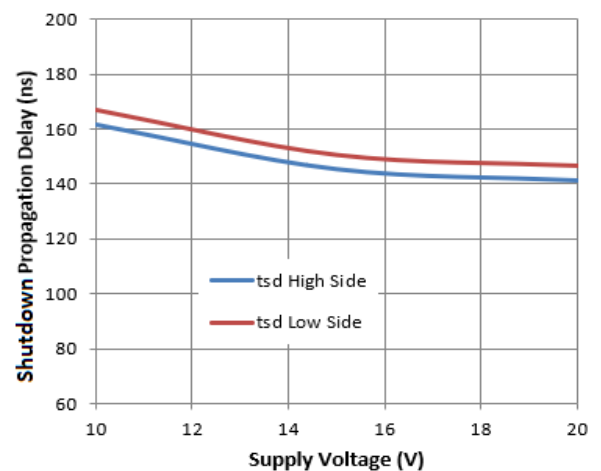

Figure 9. SD Propagation Delay vs. Supply Voltage

Typical Performance Characteristics (continued)

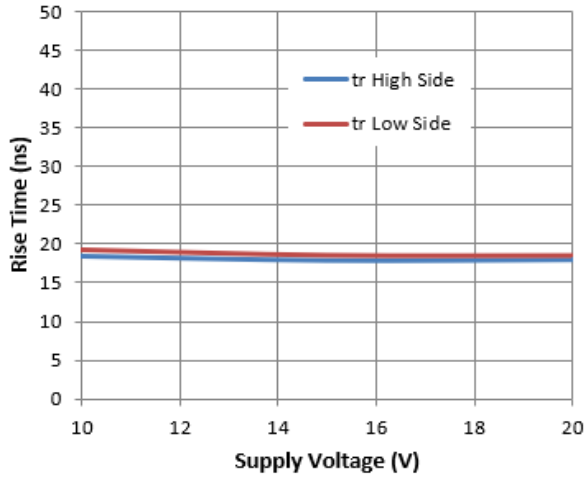

Figure 10. Rise Time vs. Supply Voltage

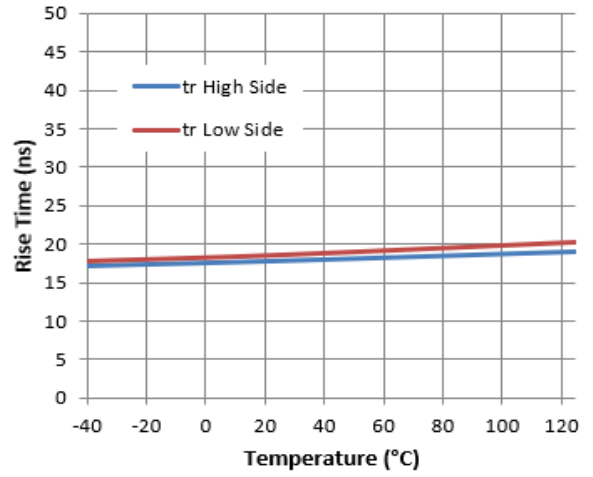

Figure 11. Rise Time vs. Temperature

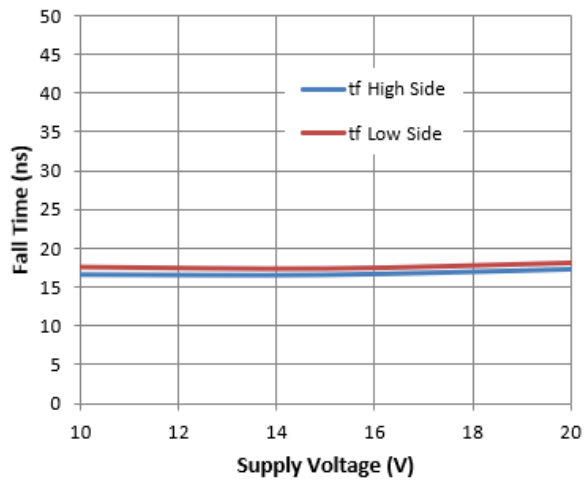

Figure 12. Fall Time vs. Supply Voltage

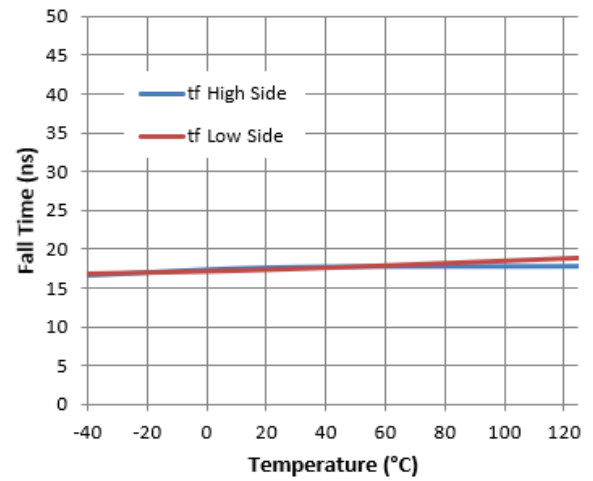

Figure 13. Fall Time vs. Temperature

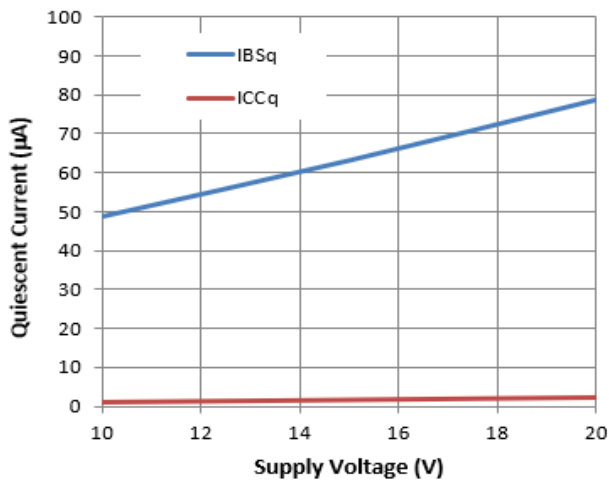

Figure 14. Quiescent Current vs. Supply Voltage

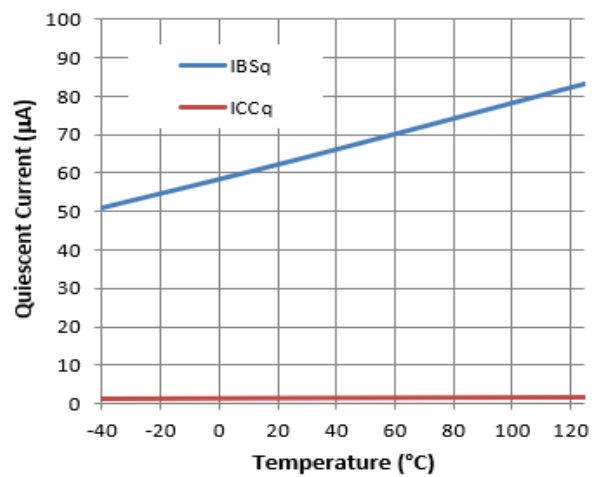

Figure 15. Quiescent Current vs. Temperature

Typical Performance Characteristics (continued)

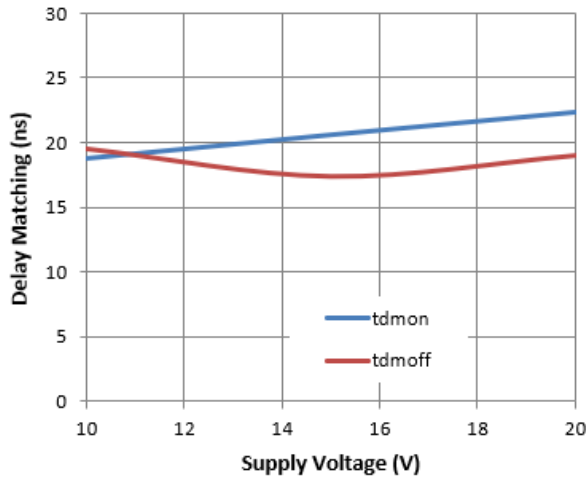

Figure 16. Delay Matching vs. Supply Voltage

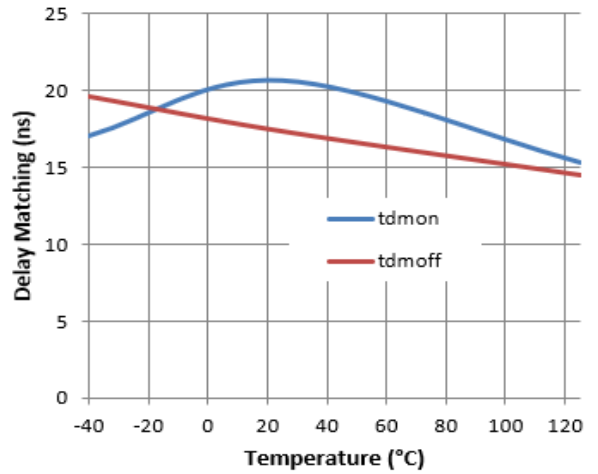

Figure 17. Delay Matching vs. Temperature

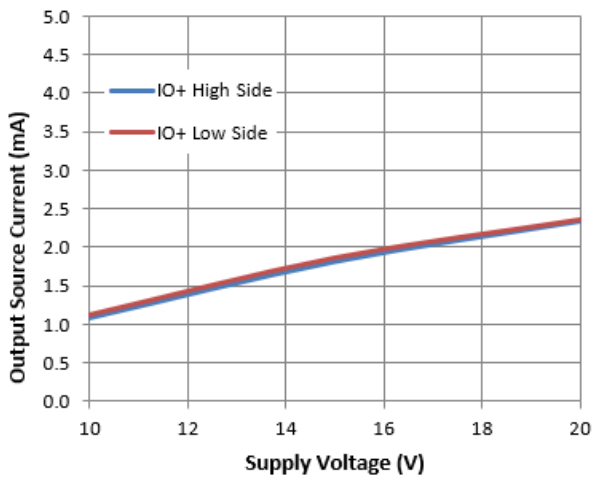

Figure 18. Output Source Current vs. Supply Voltage

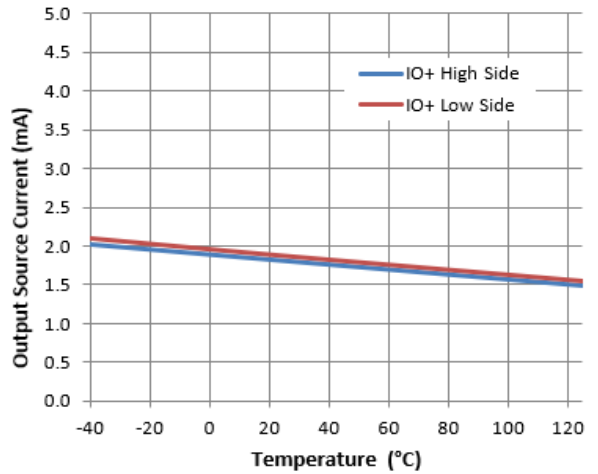

Figure 19. Output Source Current vs. Temperature

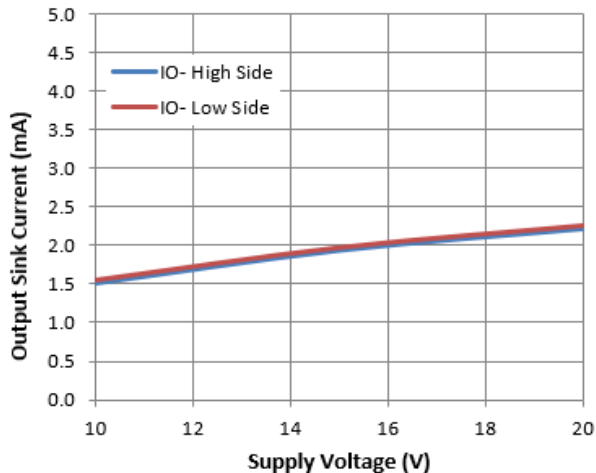

Figure 20. Output Sink Current vs. Supply Voltage

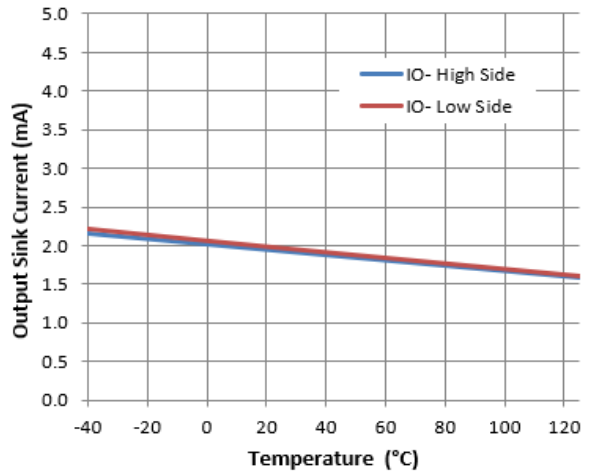

Figure 21. Output Sink Current vs. Temperature

Typical Performance Characteristics (continued)

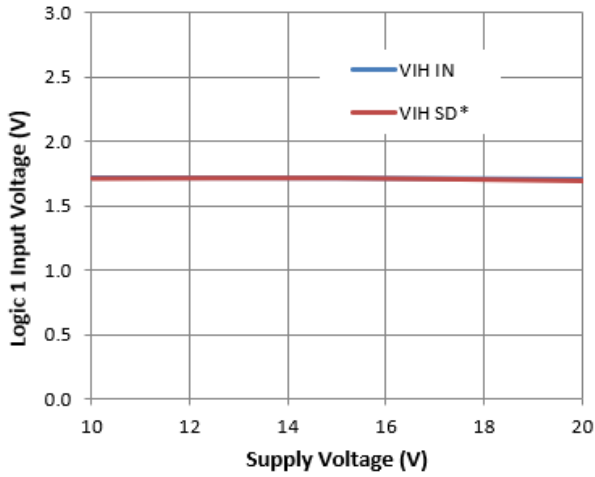

Figure 22. Logic 1 Input Voltage vs. Supply Voltage

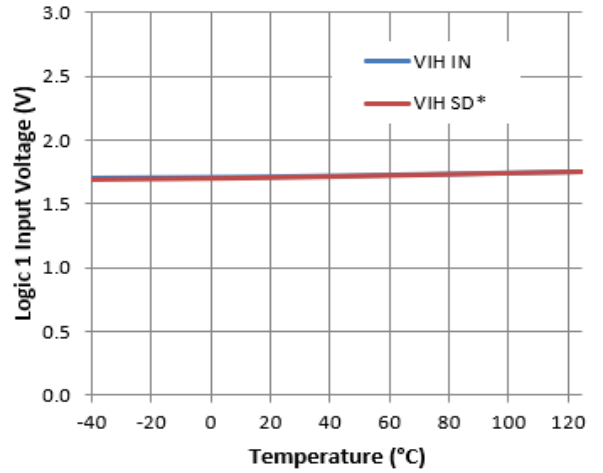

Figure 23. Logic 1 Input Voltage vs. Temperature

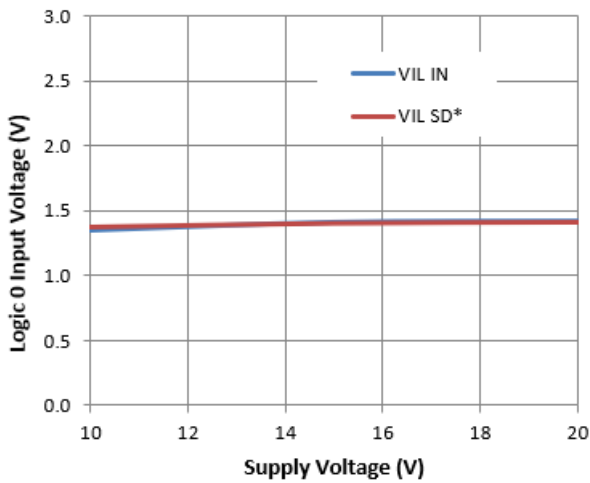

Figure 24. Logic 0 Input Voltage vs. Supply Voltage

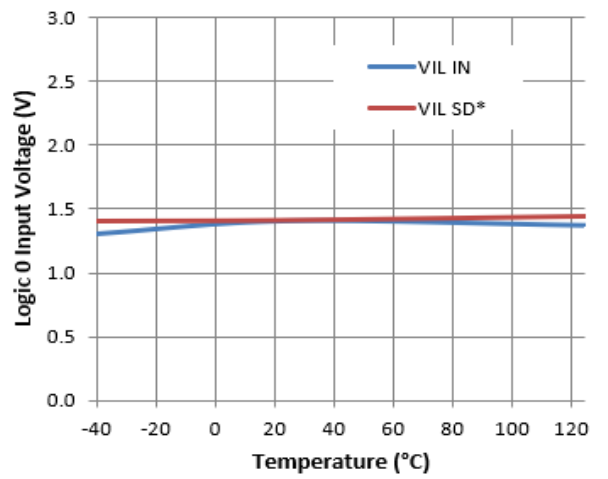

Figure 25. Logic 0 Input Voltage vs. Temperature

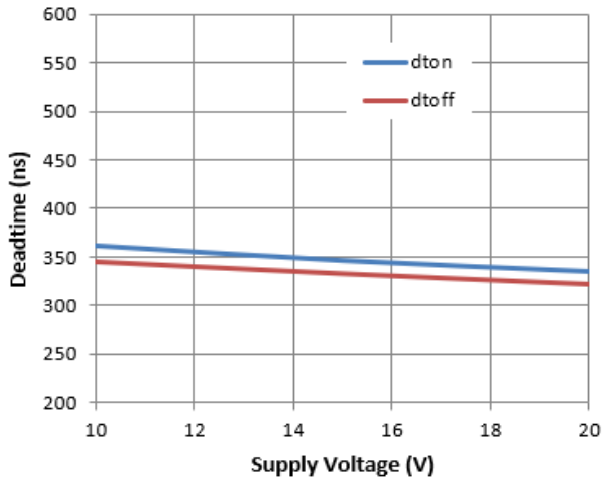

Figure 26. Deadtime vs. Supply Voltage

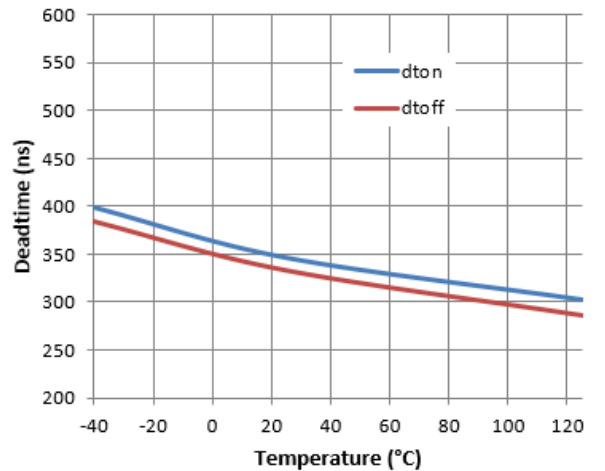

Figure 27. Deadtime vs. Temperature

Typical Performance Characteristics (continued)

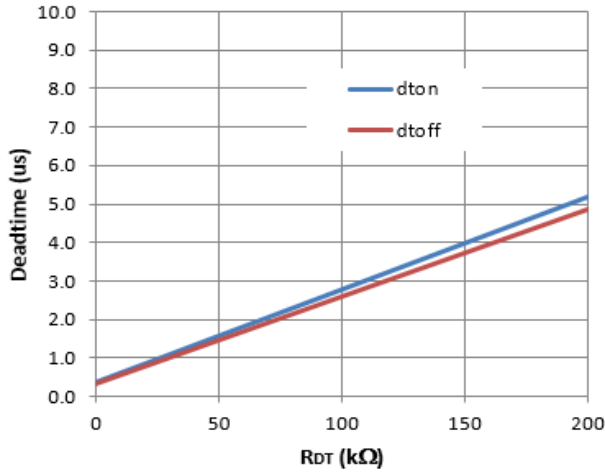

Figure 28. Deadtime vs. RDT

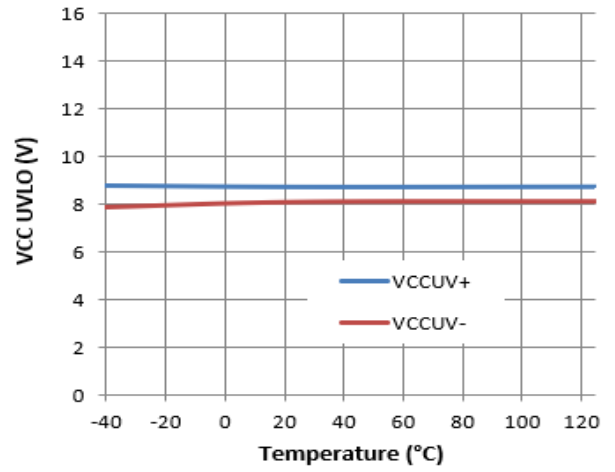

Figure 29. VCC UVLO vs. Temperature

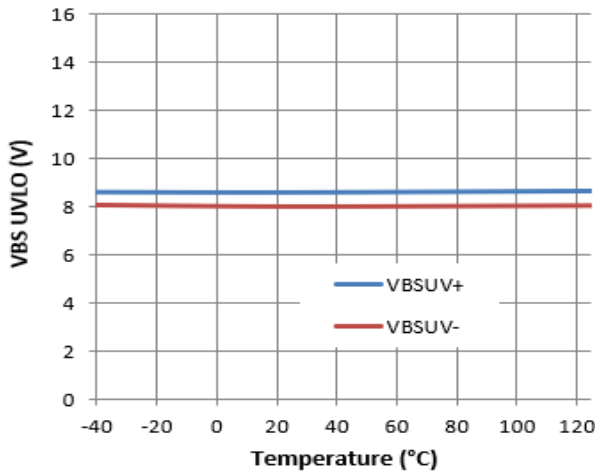

Figure 30. VBS UVLO vs. Temperature

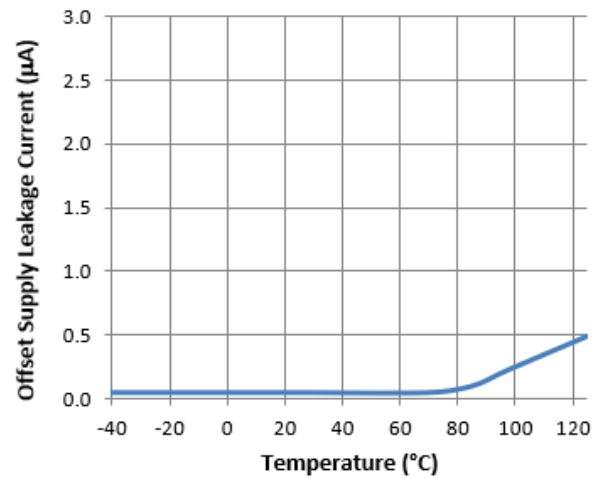
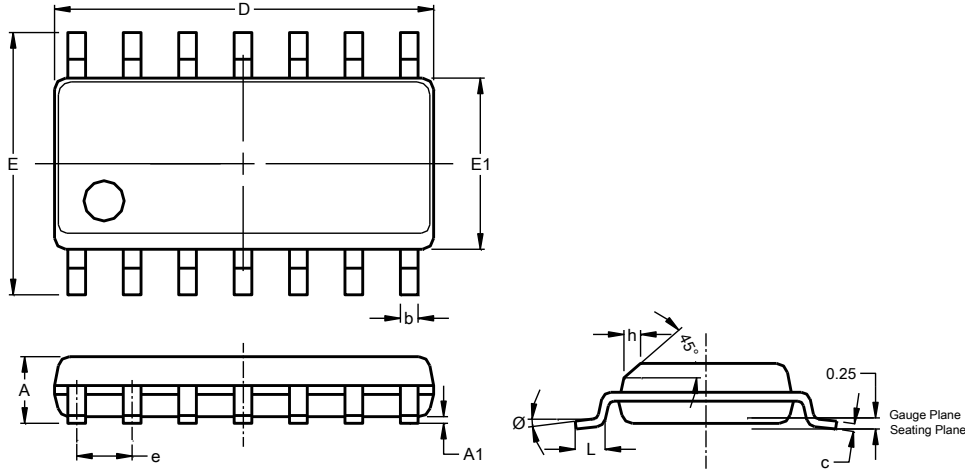

Figure 31. Offset Supply Leakage Current vs. Temperature

Package Outline Dimensions

Please see <http://www.diodes.com/package-outlines.html> for the latest version.

SO-14 (Type TH)



SO-14 (Type TH)			
Dim	Min	Max	Typ
A	1.55	1.73	--
A1	0.10	0.25	--
b	0.35	0.51	--
c	0.190	0.248	--
D	8.56	8.74	8.61
E	5.84	6.20	6.00
E1	3.81	3.99	3.94
e	--	--	1.27
h	--	--	0.33
L	0.41	0.89	--
Ø	0°	8°	--
All Dimensions in mm			

Suggested Pad Layout

Please see <http://www.diodes.com/package-outlines.html> for the latest version.

SO-14 (Type TH)

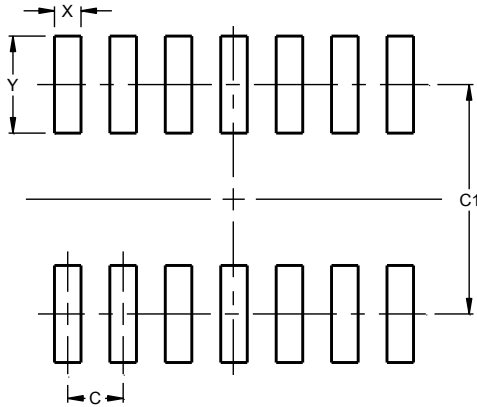

Dimensions	Value (in mm)
C	1.27
C1	5.20
X	0.60
Y	2.20

IMPORTANT NOTICE

1. DIODES INCORPORATED (Diodes) AND ITS SUBSIDIARIES MAKE NO WARRANTY OF ANY KIND, EXPRESS OR IMPLIED, WITH REGARDS TO ANY INFORMATION CONTAINED IN THIS DOCUMENT, INCLUDING, BUT NOT LIMITED TO, THE IMPLIED WARRANTIES OF MERCHANTABILITY, FITNESS FOR A PARTICULAR PURPOSE OR NON-INFRINGEMENT OF THIRD PARTY INTELLECTUAL PROPERTY RIGHTS (AND THEIR EQUIVALENTS UNDER THE LAWS OF ANY JURISDICTION).
2. The Information contained herein is for informational purpose only and is provided only to illustrate the operation of Diodes' products described herein and application examples. Diodes does not assume any liability arising out of the application or use of this document or any product described herein. This document is intended for skilled and technically trained engineering customers and users who design with Diodes' products. Diodes' products may be used to facilitate safety-related applications; however, in all instances customers and users are responsible for (a) selecting the appropriate Diodes products for their applications, (b) evaluating the suitability of Diodes' products for their intended applications, (c) ensuring their applications, which incorporate Diodes' products, comply the applicable legal and regulatory requirements as well as safety and functional-safety related standards, and (d) ensuring they design with appropriate safeguards (including testing, validation, quality control techniques, redundancy, malfunction prevention, and appropriate treatment for aging degradation) to minimize the risks associated with their applications.
3. Diodes assumes no liability for any application-related information, support, assistance or feedback that may be provided by Diodes from time to time. Any customer or user of this document or products described herein will assume all risks and liabilities associated with such use, and will hold Diodes and all companies whose products are represented herein or on Diodes' websites, harmless against all damages and liabilities.
4. Products described herein may be covered by one or more United States, international or foreign patents and pending patent applications. Product names and markings noted herein may also be covered by one or more United States, international or foreign trademarks and trademark applications. Diodes does not convey any license under any of its intellectual property rights or the rights of any third parties (including third parties whose products and services may be described in this document or on Diodes' website) under this document.
5. Diodes' products are provided subject to Diodes' Standard Terms and Conditions of Sale (<https://www.diodes.com/about/company/terms-and-conditions/terms-and-conditions-of-sales/>) or other applicable terms. This document does not alter or expand the applicable warranties provided by Diodes. Diodes does not warrant or accept any liability whatsoever in respect of any products purchased through unauthorized sales channel.
6. Diodes' products and technology may not be used for or incorporated into any products or systems whose manufacture, use or sale is prohibited under any applicable laws and regulations. Should customers or users use Diodes' products in contravention of any applicable laws or regulations, or for any unintended or unauthorized application, customers and users will (a) be solely responsible for any damages, losses or penalties arising in connection therewith or as a result thereof, and (b) indemnify and hold Diodes and its representatives and agents harmless against any and all claims, damages, expenses, and attorney fees arising out of, directly or indirectly, any claim relating to any noncompliance with the applicable laws and regulations, as well as any unintended or unauthorized application.
7. While efforts have been made to ensure the information contained in this document is accurate, complete and current, it may contain technical inaccuracies, omissions and typographical errors. Diodes does not warrant that information contained in this document is error-free and Diodes is under no obligation to update or otherwise correct this information. Notwithstanding the foregoing, Diodes reserves the right to make modifications, enhancements, improvements, corrections or other changes without further notice to this document and any product described herein. This document is written in English but may be translated into multiple languages for reference. Only the English version of this document is the final and determinative format released by Diodes.
8. Any unauthorized copying, modification, distribution, transmission, display or other use of this document (or any portion hereof) is prohibited. Diodes assumes no responsibility for any losses incurred by the customers or users or any third parties arising from any such unauthorized use.
9. This Notice may be periodically updated with the most recent version available at <https://www.diodes.com/about/company/terms-and-conditions/important-notice>

The Diodes logo is a registered trademark of Diodes Incorporated in the United States and other countries.
All other trademarks are the property of their respective owners.
© 2023 Diodes Incorporated. All Rights Reserved.

www.diodes.com