

Product Summary

BV _{DSS}	R _{DS(ON)} Max	I _D Max T _C = +25°C (Note 5)
60V	3.1mΩ @ V _{GS} = 10V	100A
	4.5mΩ @ V _{GS} = 4.5V	100A

Features

- Rated to +175°C – Ideal for High Ambient Temperature Environments
- 100% Unclamped Inductive Switching (UIS) Test in Production – Ensures More Reliable and Robust End Application
- Low R_{DS(ON)} – Minimizes Power Losses
- Low Q_g – Minimizes Switching Losses
- **Lead-Free Finish; RoHS Compliant (Notes 1 & 2)**
- **Halogen and Antimony Free. “Green” Device (Note 3)**
- **The DMTH6004LPSWQ is suitable for automotive applications requiring specific change control; this part is AEC-Q101 qualified, PPAP capable, and manufactured in IATF16949 certified facilities.**

<https://www.diodes.com/quality/product-definitions/>

Description and Applications

This MOSFET is designed to meet the stringent requirements of automotive applications. It is qualified to AEC-Q101, supported by a PPAP and is ideal for use in:

- Primary switches in isolated DC-DC
- Synchronous rectifiers
- Load switches

Mechanical Data

- Package: PowerDI[®]5060-8
- Package Material: Molded Plastic, “Green” Molding Compound. UL Flammability Classification Rating 94V-0
- Moisture Sensitivity: Level 1 per J-STD-020
- Terminals: Finish – Matte Tin Annealed over Copper Leadframe; Solderable per MIL-STD-202, Method 208 (E3)
- Weight: 0.097 grams (Approximate)

PowerDI5060-8/SWP (Type UX)

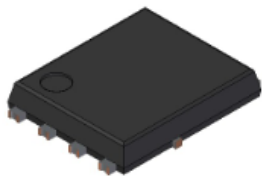

Top View

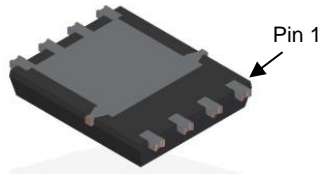

Bottom View

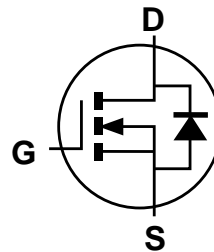

Internal Schematic

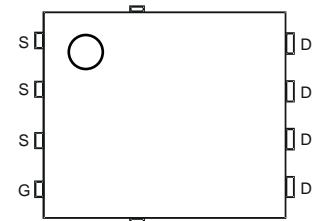

Top View
Pin Configuration

Ordering Information (Note 4)

Part Number	Package	Packing	
		Qty.	Carrier
DMTH6004LPSWQ-13	PowerDI5060-8/SWP (Type UX)	2,500	Tape & Reel

- Notes:
1. EU Directive 2002/95/EC (RoHS), 2011/65/EU (RoHS 2) & 2015/863/EU (RoHS 3) compliant. All applicable RoHS exemptions applied.
 2. See <https://www.diodes.com/quality/lead-free/> for more information about Diodes Incorporated's definitions of Halogen- and Antimony-free, "Green" and Lead-free.
 3. Halogen- and Antimony-free "Green" products are defined as those which contain <900ppm bromine, <900ppm chlorine (<1500ppm total Br + Cl) and <1000ppm antimony compounds.
 4. For packaging details, go to our website at <https://www.diodes.com/design/support/packaging/diodes-packaging/>.
 5. Limited by package.

Marking Information

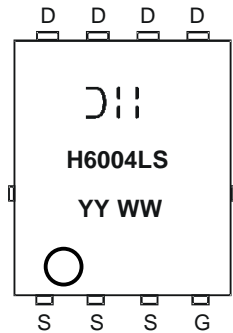

= Manufacturer's Marking
 H6004LS = Product Type Marking Code
 YYWW = Date Code Marking
 YY = Year Code (ex: 23 = 2023)
 WW = Week Code (01 to 53)

Maximum Ratings (@T_A = +25°C, unless otherwise specified.)

Characteristic	Symbol	Value	Unit
Drain-Source Voltage	V _{DSS}	60	V
Gate-Source Voltage	V _{GSS}	±20	V
Continuous Drain Current (Note 6)	I _D	T _A = +25°C	22
		T _A = +70°C	16
Continuous Drain Current (Notes 5 & 7)	I _D	T _C = +25°C	100
		T _C = +100°C	100
Maximum Continuous Body Diode Forward Current (Note 6)	I _S	100	A
Pulsed Drain Current (10µs Pulse, Duty Cycle = 1%)	I _{DM}	400	A
Pulsed Body Diode Forward Current (10µs Pulse, Duty Cycle = 1%)	I _{SM}	400	A
Avalanche Current, L = 0.2mH	I _{AS}	40	A
Avalanche Energy, L = 0.2mH	E _{AS}	160	mJ

Thermal Characteristic

Characteristic	Symbol	Value	Unit
Total Power Dissipation (Note 6)	P _D	T _A = +25°C	2.6
Thermal Resistance, Junction to Ambient (Note 6)		R _{θJA}	47
Total Power Dissipation (Note 7)	P _D	T _C = +25°C	138
Thermal Resistance, Junction to Case (Note 7)		R _{θJC}	0.9
Operating and Storage Temperature Range	T _J , T _{STG}	-55 to +175	°C

Notes: 5. Limited by package.
 6. Device mounted on FR-4 substrate PC board, 2oz copper, with thermal bias to bottom layer 1inch square copper plate.
 7. Thermal resistance from junction to soldering point (on the exposed drain pad).

Electrical Characteristics (@T_A = +25°C, unless otherwise specified.)

Characteristic	Symbol	Min	Typ	Max	Unit	Test Condition
OFF CHARACTERISTICS (Note 8)						
Drain-Source Breakdown Voltage	BV _{DSS}	60	—	—	V	V _{GS} = 0V, I _D = 1mA
Zero Gate Voltage Drain Current	I _{DSS}	—	—	1	μA	V _{DS} = 48V, V _{GS} = 0V
Gate-Source Leakage	I _{GSS}	—	—	±100	nA	V _{GS} = ±20V, V _{DS} = 0V
ON CHARACTERISTICS (Note 8)						
Gate Threshold Voltage	V _{GS(TH)}	1	—	3	V	V _{DS} = V _{GS} , I _D = 250μA
Static Drain-Source On-Resistance	R _{DS(ON)}	—	2.5	3.1	mΩ	V _{GS} = 10V, I _D = 25A
		—	3.3	4.5	mΩ	V _{GS} = 4.5V, I _D = 20A
Diode Forward Voltage	V _{SD}	—	—	1.3	V	V _{GS} = 0V, I _S = 25A
DYNAMIC CHARACTERISTICS (Note 9)						
Input Capacitance	C _{ISS}	—	5399	—	pF	V _{DS} = 30V, V _{GS} = 0V f = 1MHz
Output Capacitance	C _{OSS}	—	1306	—		
Reverse Transfer Capacitance	C _{RSS}	—	92	—	Ω	V _{DS} = 0V, V _{GS} = 0V, f = 1MHz
Gate Resistance	R _g	—	0.64	—		
Total Gate Charge (V _{GS} = 10V)	Q _g	—	78.3	—	nC	V _{DD} = 30V, I _D = 25A
Total Gate Charge (V _{GS} = 4.5V)	Q _g	—	38.5	—		
Gate-Source Charge	Q _{gs}	—	10.2	—		
Gate-Drain Charge	Q _{gd}	—	20.4	—		
Turn-On Delay Time	t _{D(ON)}	—	9.9	—	ns	V _{DD} = 30V, V _{GS} = 10V I _D = 25A, R _g = 3.5Ω
Turn-On Rise Time	t _R	—	17.7	—		
Turn-Off Delay Time	t _{D(OFF)}	—	53.5	—		
Turn-Off Fall Time	t _F	—	32.9	—		
Body Diode Reverse Recovery Time	t _{RR}	—	49.7	—	ns	I _F = 25A, dI/dt = 100A/μs
Body Diode Reverse Recovery Charge	Q _{RR}	—	78.9	—	nC	

Notes: 8. Short duration pulse test used to minimize self-heating effect.
9. Guaranteed by design. Not subject to production testing.

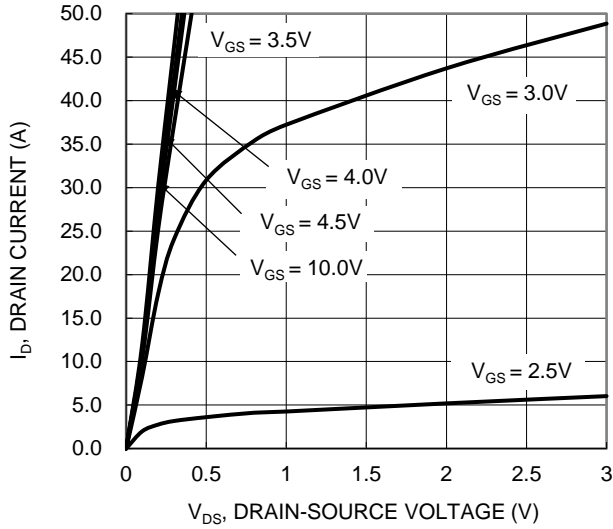

Figure 1. Typical Output Characteristic

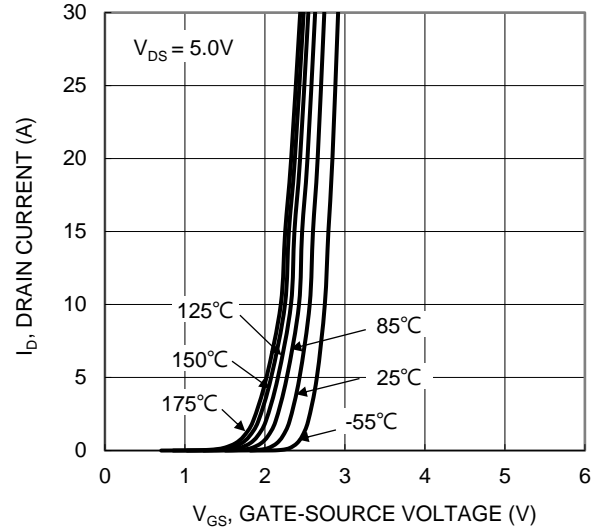

Figure 2. Typical Transfer Characteristic

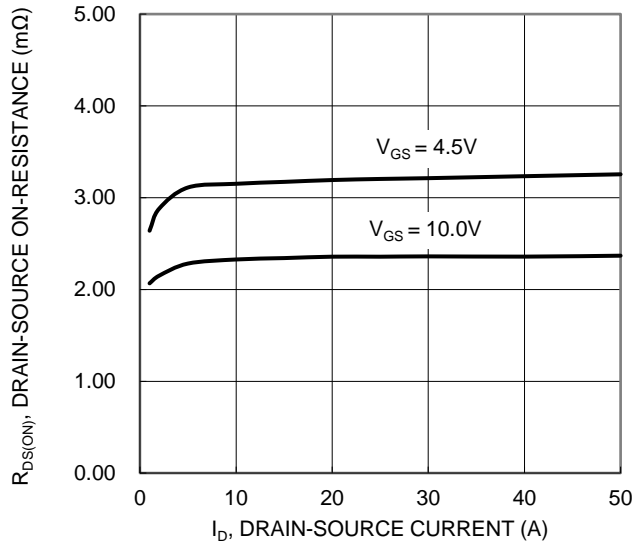

Figure 3. Typical On-Resistance vs. Drain Current and Gate Voltage

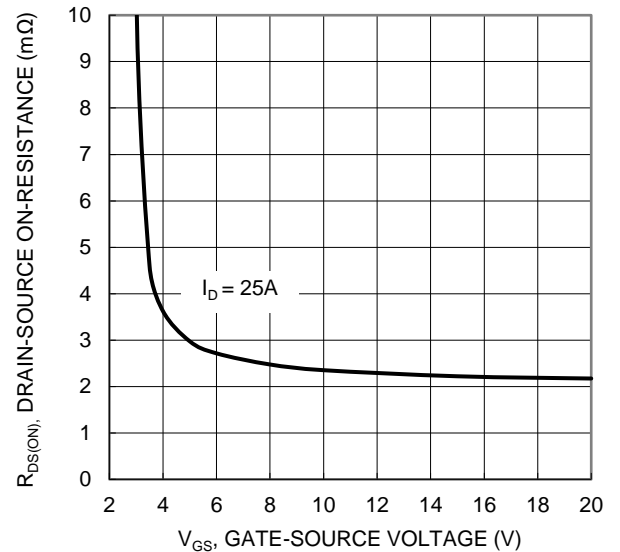

Figure 4. Typical Transfer Characteristic

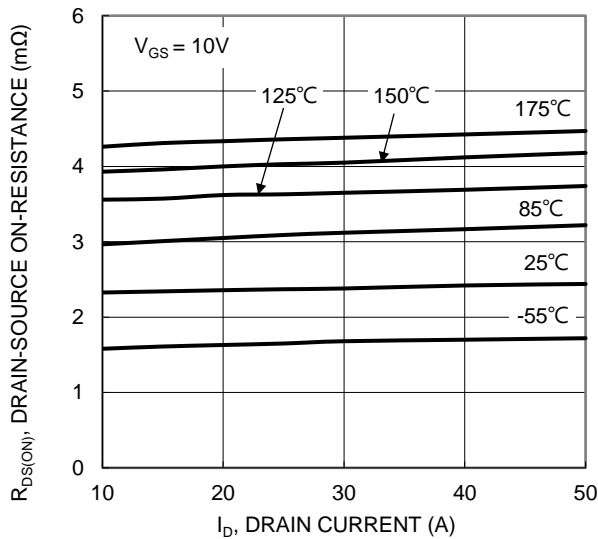

Figure 5. Typical On-Resistance vs. Drain Current and Temperature

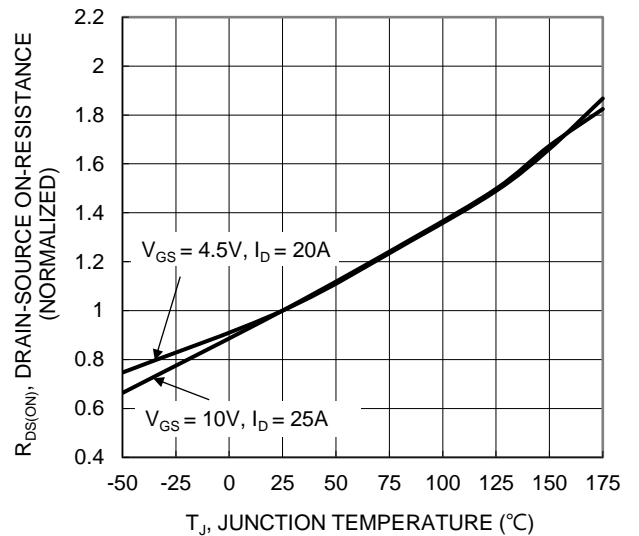

Figure 6. On-Resistance Variation with Temperature

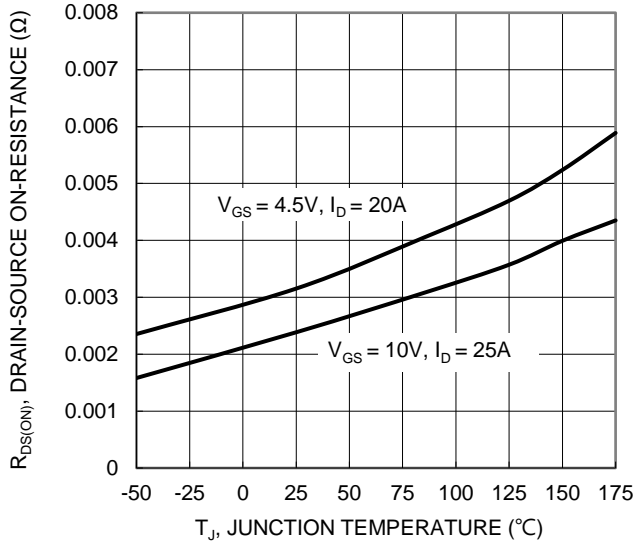

Figure 7. On-Resistance Variation with Temperature

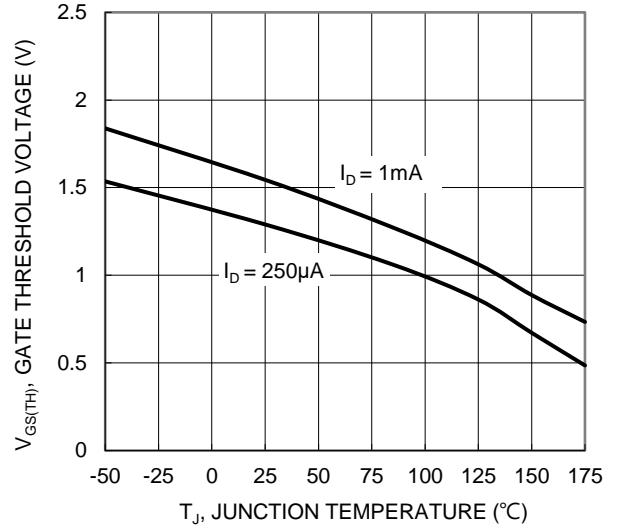

Figure 8. Gate Threshold Variation vs. Temperature

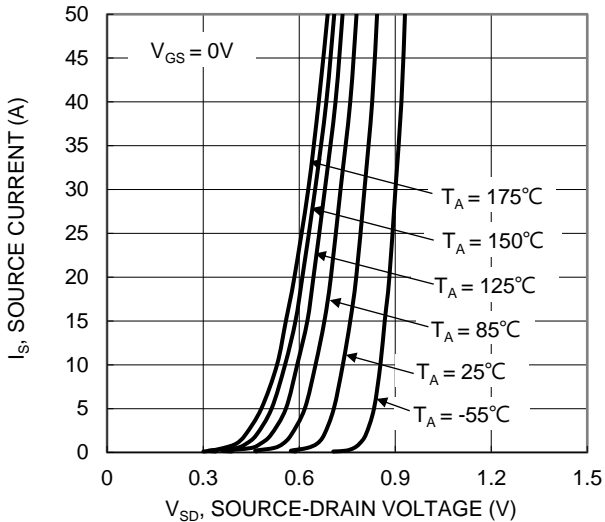

Figure 9. Diode Forward Voltage vs. Current

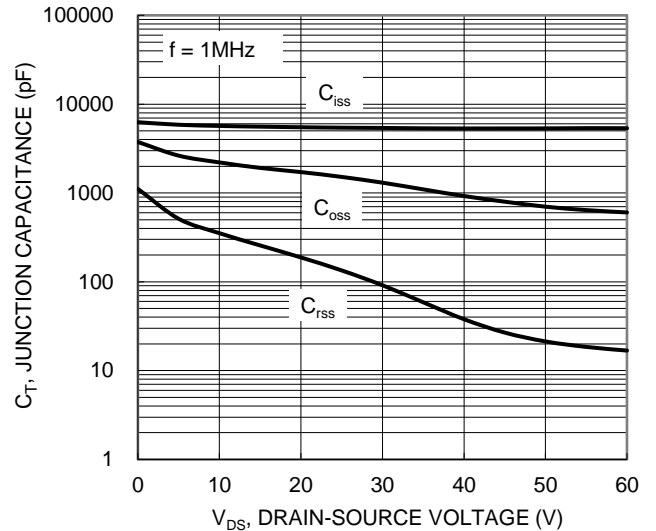

Figure 10. Typical Junction Capacitance

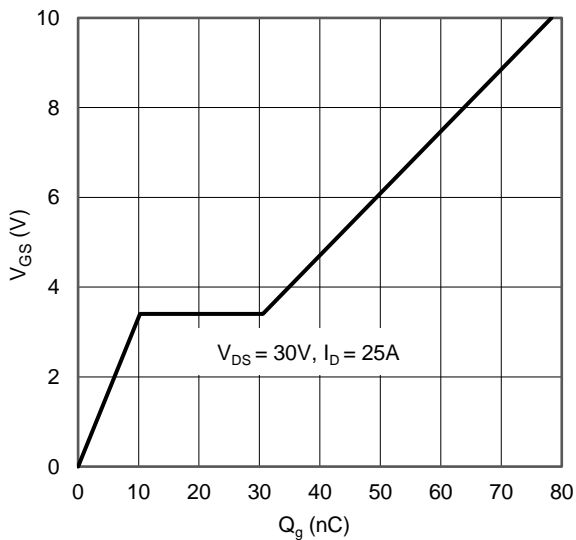

Figure 11. Gate Charge

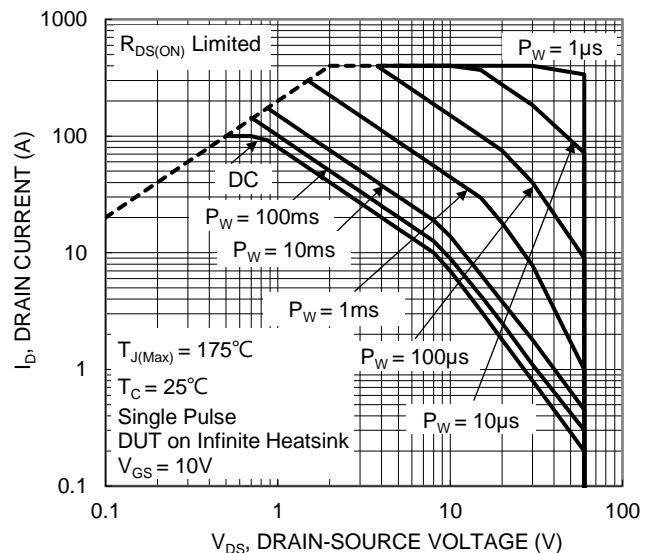

Figure 12. SOA, Safe Operation Area

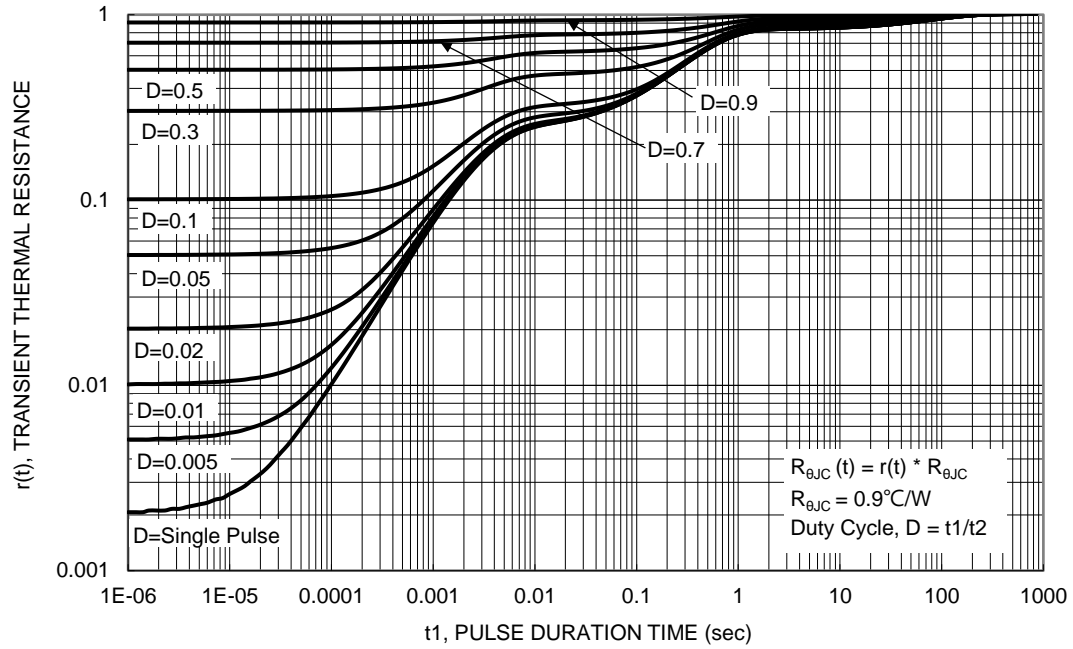
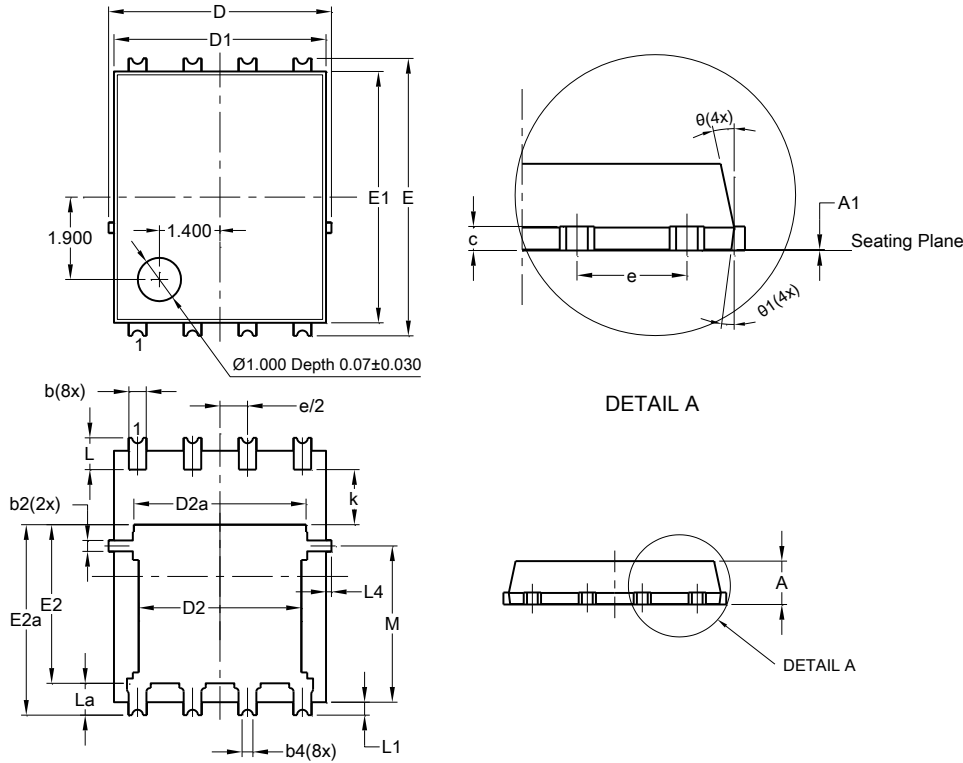

Figure 13. Transient Thermal Resistance

Package Outline Dimensions

Please see <http://www.diodes.com/package-outlines.html> for the latest version.

PowerDI5060-8/SWP (Type UX)



PowerDI5060-8/SWP (Type UX)			
Dim	Min	Max	Typ
A	0.90	1.10	1.00
A1	0	0.05	--
b	0.30	0.50	0.41
b2	0.20	0.35	0.25
b4	0.25REF		
c	0.230	0.330	0.277
D	5.15 BSC		
D1	4.70	5.10	4.90
D2	3.56	3.96	3.76
D2a	3.78	4.18	3.98
E	6.40 BSC		
E1	5.60	6.00	5.80
E2	3.46	3.86	3.66
E2a	4.195	4.595	4.395
e	1.27BSC		
k	1.05	--	--
L	0.635	0.835	0.735
La	0.635	0.835	0.735
L1	0.200	0.400	0.300
L1a	0.050REF		
L4	0.025	0.225	0.125
M	3.205	4.005	3.605
θ	10°	12°	11°
θ1	6°	8°	7°
All Dimensions in mm			

Suggested Pad Layout

Please see <http://www.diodes.com/package-outlines.html> for the latest version.

PowerDI5060-8/SWP (Type UX)

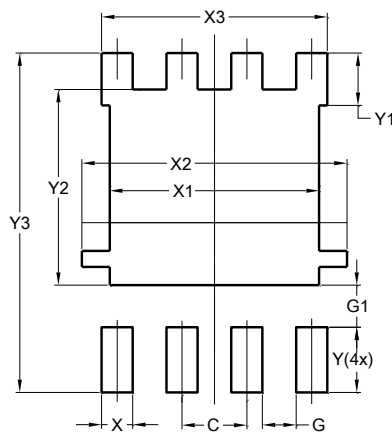

Dimensions	Value (in mm)
C	1.270
G	0.660
G1	0.820
X	0.610
X1	4.100
X2	5.190
X3	4.420
Y	1.270
Y1	1.020
Y2	3.810
Y3	6.610

IMPORTANT NOTICE

1. DIODES INCORPORATED (Diodes) AND ITS SUBSIDIARIES MAKE NO WARRANTY OF ANY KIND, EXPRESS OR IMPLIED, WITH REGARDS TO ANY INFORMATION CONTAINED IN THIS DOCUMENT, INCLUDING, BUT NOT LIMITED TO, THE IMPLIED WARRANTIES OF MERCHANTABILITY, FITNESS FOR A PARTICULAR PURPOSE OR NON-INFRINGEMENT OF THIRD PARTY INTELLECTUAL PROPERTY RIGHTS (AND THEIR EQUIVALENTS UNDER THE LAWS OF ANY JURISDICTION).
2. The Information contained herein is for informational purpose only and is provided only to illustrate the operation of Diodes' products described herein and application examples. Diodes does not assume any liability arising out of the application or use of this document or any product described herein. This document is intended for skilled and technically trained engineering customers and users who design with Diodes' products. Diodes' products may be used to facilitate safety-related applications; however, in all instances customers and users are responsible for (a) selecting the appropriate Diodes products for their applications, (b) evaluating the suitability of Diodes' products for their intended applications, (c) ensuring their applications, which incorporate Diodes' products, comply the applicable legal and regulatory requirements as well as safety and functional-safety related standards, and (d) ensuring they design with appropriate safeguards (including testing, validation, quality control techniques, redundancy, malfunction prevention, and appropriate treatment for aging degradation) to minimize the risks associated with their applications.
3. Diodes assumes no liability for any application-related information, support, assistance or feedback that may be provided by Diodes from time to time. Any customer or user of this document or products described herein will assume all risks and liabilities associated with such use, and will hold Diodes and all companies whose products are represented herein or on Diodes' websites, harmless against all damages and liabilities.
4. Products described herein may be covered by one or more United States, international or foreign patents and pending patent applications. Product names and markings noted herein may also be covered by one or more United States, international or foreign trademarks and trademark applications. Diodes does not convey any license under any of its intellectual property rights or the rights of any third parties (including third parties whose products and services may be described in this document or on Diodes' website) under this document.
5. Diodes' products are provided subject to Diodes' Standard Terms and Conditions of Sale (<https://www.diodes.com/about/company/terms-and-conditions/terms-and-conditions-of-sales/>) or other applicable terms. This document does not alter or expand the applicable warranties provided by Diodes. Diodes does not warrant or accept any liability whatsoever in respect of any products purchased through unauthorized sales channel.
6. Diodes' products and technology may not be used for or incorporated into any products or systems whose manufacture, use or sale is prohibited under any applicable laws and regulations. Should customers or users use Diodes' products in contravention of any applicable laws or regulations, or for any unintended or unauthorized application, customers and users will (a) be solely responsible for any damages, losses or penalties arising in connection therewith or as a result thereof, and (b) indemnify and hold Diodes and its representatives and agents harmless against any and all claims, damages, expenses, and attorney fees arising out of, directly or indirectly, any claim relating to any noncompliance with the applicable laws and regulations, as well as any unintended or unauthorized application.
7. While efforts have been made to ensure the information contained in this document is accurate, complete and current, it may contain technical inaccuracies, omissions and typographical errors. Diodes does not warrant that information contained in this document is error-free and Diodes is under no obligation to update or otherwise correct this information. Notwithstanding the foregoing, Diodes reserves the right to make modifications, enhancements, improvements, corrections or other changes without further notice to this document and any product described herein. This document is written in English but may be translated into multiple languages for reference. Only the English version of this document is the final and determinative format released by Diodes.
8. Any unauthorized copying, modification, distribution, transmission, display or other use of this document (or any portion hereof) is prohibited. Diodes assumes no responsibility for any losses incurred by the customers or users or any third parties arising from any such unauthorized use.
9. This Notice may be periodically updated with the most recent version available at <https://www.diodes.com/about/company/terms-and-conditions/important-notice>

The Diodes logo is a registered trademark of Diodes Incorporated in the United States and other countries.
All other trademarks are the property of their respective owners.
© 2023 Diodes Incorporated. All Rights Reserved.

www.diodes.com