

# 1.2V CMOS Low Jitter XO

**FM**

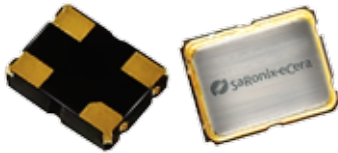

2.0 x 1.6mm Ceramic SMD

### Product Features

- 1-50 MHz Frequency Range
- <1 ps RMS jitter
- 1.2V CMOS compatible logic levels
- Designed for standard reflow and washing techniques
- Low power standby mode: 10µA max
- Pb-free and RoHS/Green compliant

### Product Description

The FM Series crystal clock oscillator achieves superb jitter and stability over a broad range of operating conditions and frequencies. The output clock signal, generated internally with a non-PLL oscillator design, is compatible with LVCMOS logic levels. The device, available on tape and reel, is contained in a 2.0 x 1.6 mm surface-mount ceramic package.

### Applications

Ideal for compact, high density applications:

- WLAN
- HBA
- Portable Multimedia Player (PMP)
- Notebook Computer
- SDIO/ PCMCIA card
- USB BT Interface
- Bluetooth

### Package:

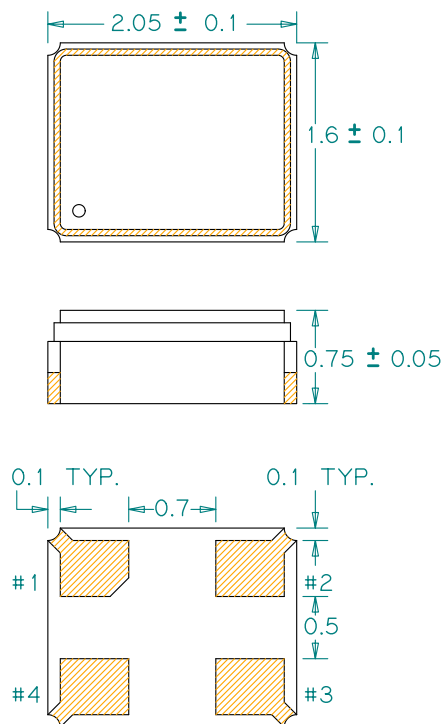

### Recommended Land Pattern:

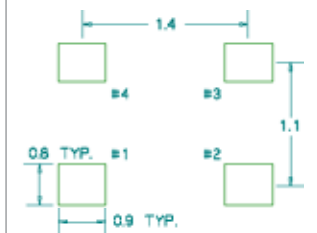

### Pin Functions:

Pin	Function
1	ED
2	Ground
3	Clock Output
4	V <sub>CC</sub>

### Part Ordering Information:

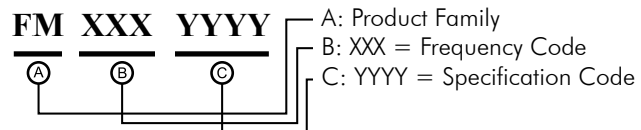

Following the above format, Saronix-eCera part numbers will be assigned upon confirmation of exact customer requirements.

### Electrical Performance

Parameter	Min.	Typ.	Max.	Units	Notes
Output Frequency	1		50	MHz	
Supply Voltage	1.08	1.20	1.32	V	
Supply Current, Output Enabled			5	mA	1 - 50 MHz
Supply Current, Standby Mode			10	A	Output Hi-Z
Frequency Stability			±20 to ±50	ppm	See Note 1 below
Operating Temperature Range	-20		+70	°C	Commercial (standard)
	-40		+85		
Output Logic 0, V <sub>OL</sub>			10% V <sub>DD</sub>	V	Industrial (standard)
Output Logic 1, V <sub>OH</sub>	90% V <sub>DD</sub>			V	
Output Load			15	pF	output requires termination
Duty Cycle	45		55	%	Measured 50% of V <sub>DD</sub>
Rise and Fall Time			7	ns	Measured 20/80% of waveform
Jitter, Phase			1	ps RMS(1-σ)	10kHz to 20 MHz frequency band
Jitter, Accumulated			5	ps RMS(1-σ)	20,000 adjacent periods
Jitter, Total			50	ps pk-pk	100,000 random periods

#### Notes:

- Stability includes all combinations of operating temperature, load changes, rated input (supply) voltage changes, initial calibration tolerance (25°C), aging (5 year at 40°C average effective ambient temperature), shock and vibration.
- For specifications other than those listed, please contact sales.

### Output Enable / Disable Function

Parameter	Min.	Typ.	Max.	Units	Notes
Input Voltage (pin 1), Output Enable	0.7 V <sub>DD</sub>			V	or open
Input Voltage (pin 1), Output Disable (low power standby)			0.3 V <sub>DD</sub>	V	Output is Hi-Z
Internal Pullup Resistance	30			kΩ	
Output Disable Delay			100	ns	
Output Enable Delay			10	ms	

### Absolute Maximum Ratings

Parameter	Min.	Typ.	Max.	Units	Notes
Storage Temperature	-55		+125	°C	

For the latest product information visit: <http://www.pericom.com/products/timing/oscillators/FM.1.2/>

For test circuit go to: [http://www.pericom.com/pdf/sre/tc\\_hcm0s2.pdf](http://www.pericom.com/pdf/sre/tc_hcm0s2.pdf)

For soldering reflow profile and reliability test ratings go to: <http://www.pericom.com/pdf/sre/reflow2.pdf>

For tape and reel information go to: [http://www.pericom.com/pdf/sre/tr\\_2016.pdf](http://www.pericom.com/pdf/sre/tr_2016.pdf)