

## Features

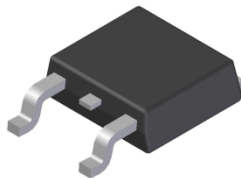
- $BV_{CEO} > 50V$
- $I_C = 2A$  Continuous Collector Current
- $I_{CM} = 3A$  Peak Pulse Current
- Ideal for Power Switching or Amplification Applications
- **Lead-Free Finish; RoHS Compliant (Notes 1 & 2)**
- **Halogen and Antimony Free. "Green" Device (Note 3)**
- **The MJD2873Q is suitable for automotive applications requiring specific change control; this part is AEC-Q101 qualified, PPAP capable, and manufactured in IATF 16949 certified facilities.**

<https://www.diodes.com/quality/product-definitions/>

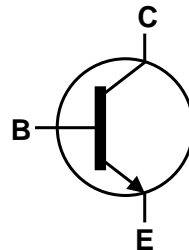
## Mechanical Data

- Package: TO252
- Package Material: Molded Plastic, "Green" Molding Compound  
UL Flammability Classification Rating 94V-0
- Moisture Sensitivity: Level 1 per J-STD-020
- Terminals: Finish – Matte Tin Plated Leads, Solderable per MIL-STD-202, Method 208 (E3)
- Weight: 0.34 grams (Approximate)

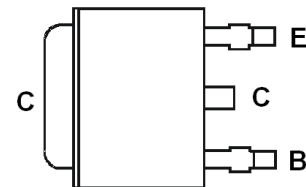
TO252 (DPAK)



Top View



Device Schematic



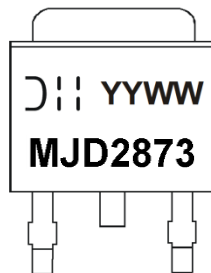
Pin Out Configuration  
Top View

## Ordering Information (Note 4)

Part Number	Package	Marking	Reel Size (inches)	Tape Width (mm)	Packing	
					Qty.	Carrier
MJD2873Q-13	TO252	MJD2873	13	16	2,500	Reel

- Notes:
1. EU Directive 2002/95/EC (RoHS), 2011/65/EU (RoHS 2) & 2015/863/EU (RoHS 3) compliant. All applicable RoHS exemptions applied.
  2. See <https://www.diodes.com/quality/lead-free/> for more information about Diodes Incorporated's definitions of Halogen- and Antimony-free, "Green" and Lead-free.
  3. Halogen- and Antimony-free "Green" products are defined as those which contain <900ppm bromine, <900ppm chlorine (<1500ppm total Br + Cl) and <1000ppm antimony compounds.
  4. For packaging details, go to our website at <https://www.diodes.com/design/support/packaging/diodes-packaging/>.

## Marking Information



MJD2873 = Product Type Marking Code  
 ⤵ = Manufacturers' Code Marking  
 YYWW = Date Code Marking  
 YY = Last Two Digits of Year (ex: 24 = 2024)  
 WW = Week Code (01 to 53)

### Absolute Maximum Ratings (@T<sub>A</sub> = +25°C, unless otherwise specified.)

Characteristic	Symbol	Value	Unit
Collector-Base Voltage	V <sub>CBO</sub>	70	V
Collector-Emitter Voltage	V <sub>CEO</sub>	50	V
Emitter-Base Voltage	V <sub>EBO</sub>	7	V
Continuous Collector Current	I <sub>C</sub>	2	A
Peak Pulse Collector Current	I <sub>CM</sub>	3	A

### Thermal Characteristics (@T<sub>A</sub> = +25°C, unless otherwise specified.)

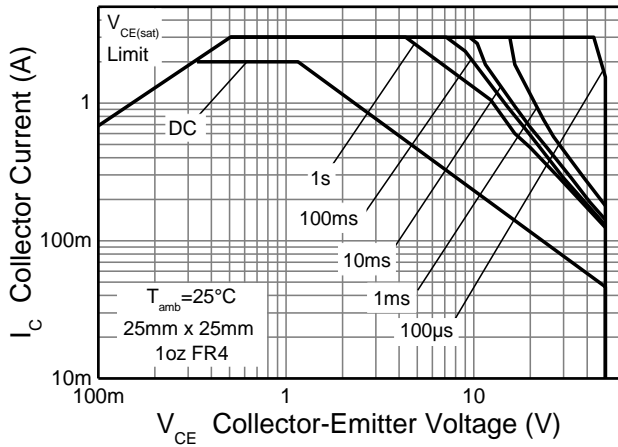
Characteristic	Symbol	Value	Unit
Power Dissipation	P <sub>D</sub>	(Note 5)	2.60
		(Note 6)	2.30
		(Note 7)	1.45
Thermal Resistance, Junction to Ambient Air	R <sub>θJA</sub>	(Note 5)	48
		(Note 6)	54
		(Note 7)	86
Operating and Storage Temperature Range	T <sub>J</sub> , T <sub>STG</sub>	-55 to +150	°C

### ESD Ratings (Note 8)

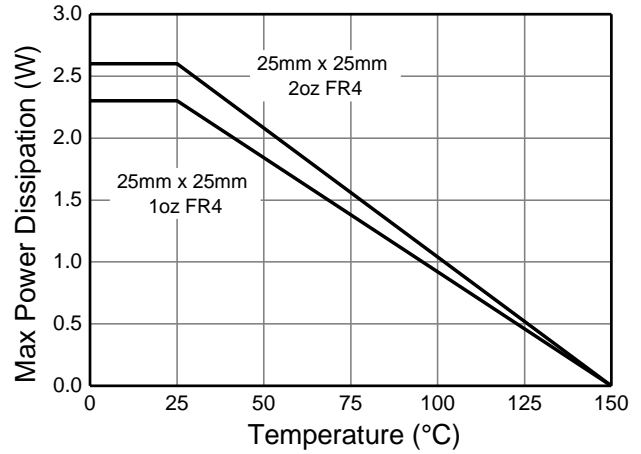
Characteristic	Symbol	Value	Unit	JEDEC Class
Electrostatic Discharge - Human Body Model	ESD HBM	4,000	V	3A
Electrostatic Discharge - Machine Model	ESD MM	400	V	C

- Notes:
5. For a device mounted with the exposed collector pad on 25mm x 25mm 2oz copper that is on a single-sided 1.6mm FR4 PCB; device is measured under still air conditions whilst operating in a steady state.
  6. Same as note (5), except mounted on 25mm x 25mm 1oz copper.
  7. Same as note (5), except mounted on minimum recommended pad (MRP) layout.
  8. Refer to JEDEC specification JESD22-A114 and JESD22-A115.

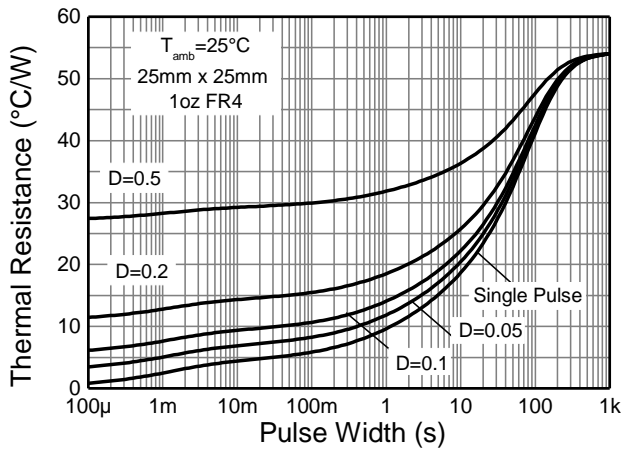
**Thermal Characteristics**



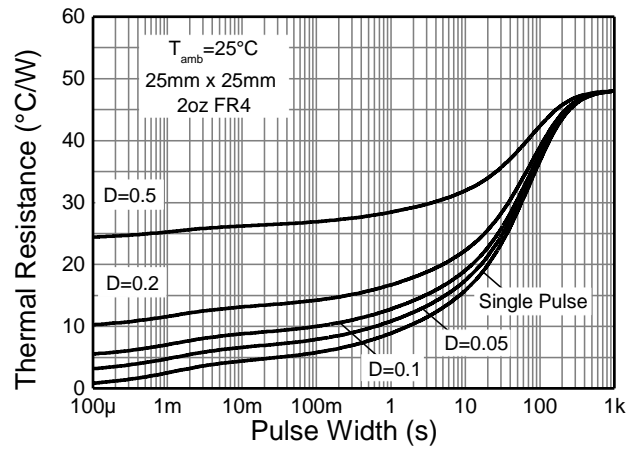
**Figure 1. Safe Operating Area**



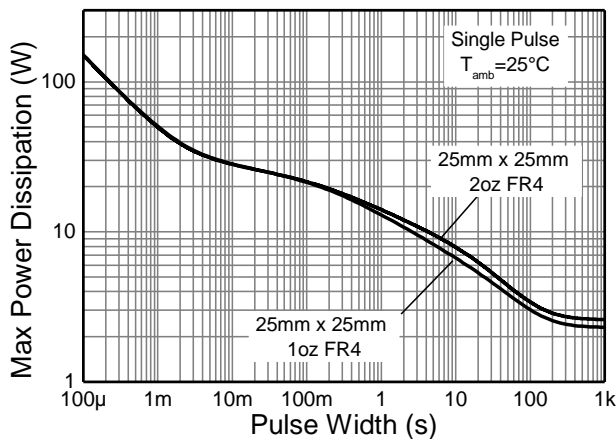
**Figure 2. Derating Curve**



**Figure 3. Transient Thermal Impedance**



**Figure 4. Transient Thermal Impedance**



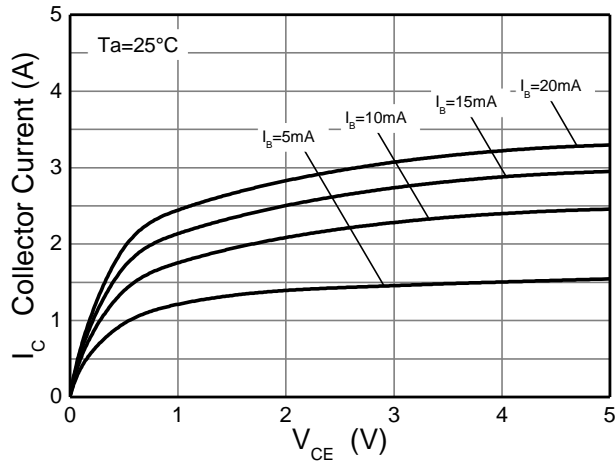
**Figure 5. Pulse Power Dissipation**

**Electrical Characteristics** (@T<sub>A</sub> = +25°C, unless otherwise specified.)

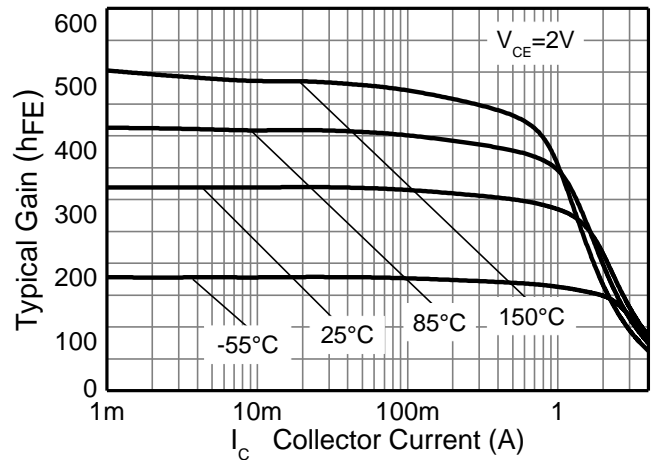
Characteristic	Symbol	Min	Typ	Max	Unit	Test Condition
Collector-Base Breakdown Voltage	BV <sub>CBO</sub>	70	—	—	V	I <sub>C</sub> = 100μA
Collector-Emitter Breakdown Voltage (Note 9)	BV <sub>CEO</sub>	50	—	—	V	I <sub>C</sub> = 10mA
Emitter-Base Breakdown Voltage	BV <sub>EBO</sub>	7	—	—	V	I <sub>E</sub> = 100μA
Collector Cut-off Current	I <sub>CES</sub>	—	—	100	nA	V <sub>CE</sub> = 50V
Collector-Base Cut-off Current	I <sub>CBO</sub>	—	—	100	nA	V <sub>CB</sub> = 70V
Emitter Cut-off Current	I <sub>EBO</sub>	—	—	100	nA	V <sub>EB</sub> = 6V
Collector-Emitter Saturation Voltage (Note 9)	V <sub>CE(sat)</sub>	—	—	0.3	V	I <sub>C</sub> = 1A, I <sub>B</sub> = 50mA
Base-Emitter Saturation Voltage (Note 9)	V <sub>BE(sat)</sub>	—	—	1.2	V	I <sub>C</sub> = 1A, I <sub>B</sub> = 50mA
Base-Emitter Turn-On Voltage (Note 9)	V <sub>BE(on)</sub>	—	—	1.2 0.95	V	I <sub>C</sub> = 1A, V <sub>CE</sub> = 2V I <sub>C</sub> = 0.75A, V <sub>CE</sub> = 1.6V
DC Current Gain (Note 9)	h <sub>FE</sub>	120 40 80	— — —	— — —	—	V <sub>CE</sub> = 2V, I <sub>C</sub> = 0.5A V <sub>CE</sub> = 2V, I <sub>C</sub> = 2A V <sub>CE</sub> = 1.6V, I <sub>C</sub> = 0.75A
Current Gain-Bandwidth Product	f <sub>T</sub>	65	—	—	MHz	I <sub>C</sub> = 0.1A, V <sub>CE</sub> = 10V, f = 100MHz
Output Capacitance	C <sub>obo</sub>	—	20	—	pF	V <sub>CB</sub> = 10V, f = 1MHz
Input Capacitance	C <sub>ibo</sub>	—	295	—	pF	V <sub>EB</sub> = 0.5V, f = 1MHz
Delay Time	t <sub>d</sub>	—	30	—	ns	I <sub>C</sub> = 0.5A, V <sub>CC</sub> = 10V I <sub>B1</sub> = -I <sub>B2</sub> = 50mA
Rise Time	t <sub>r</sub>	—	20	—	ns	
Storage Time	t <sub>s</sub>	—	380	—	ns	
Fall Time	t <sub>f</sub>	—	60	—	ns	

Note: 9. Measured under pulsed conditions. Pulse width ≤ 300μs. Duty cycle ≤ 2%.

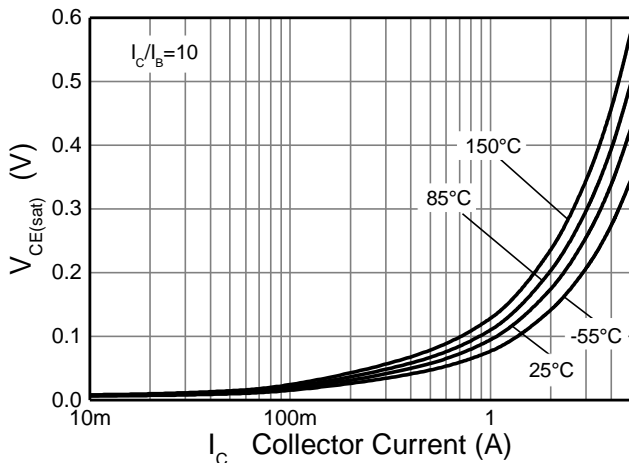
**Typical Electrical Characteristics** (@T<sub>A</sub> = +25°C, unless otherwise specified.)



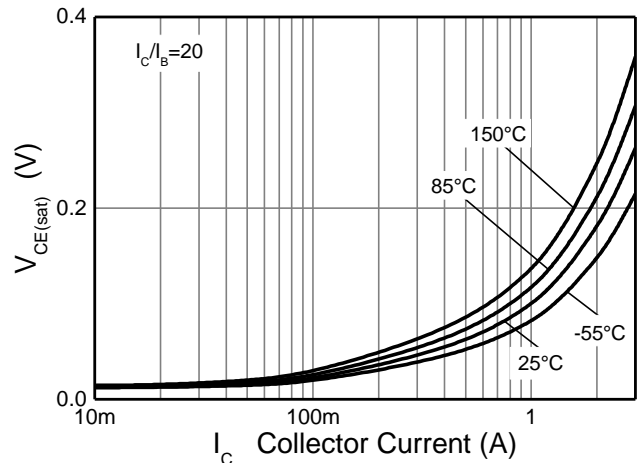
**Figure 6.  $I_C$  v  $V_{CE}$**



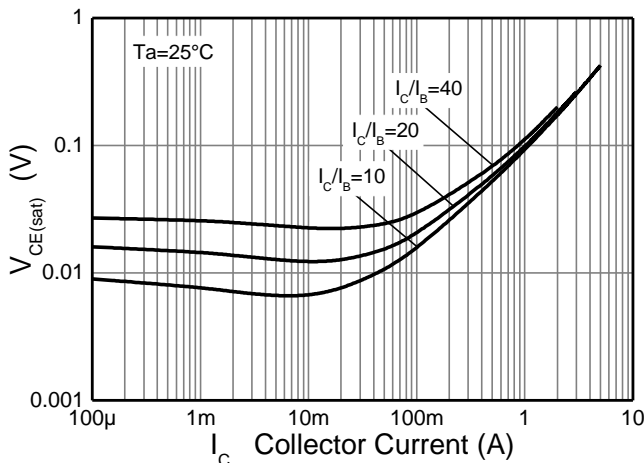
**Figure 7.  $h_{FE}$  v  $I_C$**



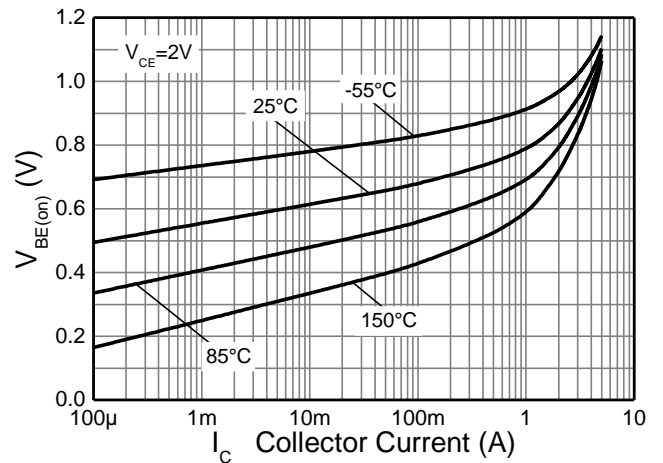
**Figure 8.  $V_{CE(sat)}$  v  $I_C$**



**Figure 9.  $V_{CE(sat)}$  v  $I_C$**

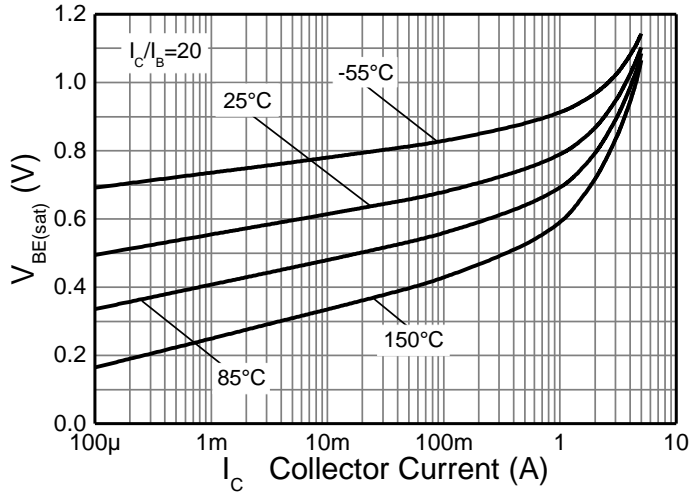


**Figure 10.  $V_{CE(sat)}$  v  $I_C$**



**Figure 11.  $V_{BE(on)}$  v  $I_C$**

**Typical Electrical Characteristics** (@T<sub>A</sub> = +25°C, unless otherwise specified.) (continued)

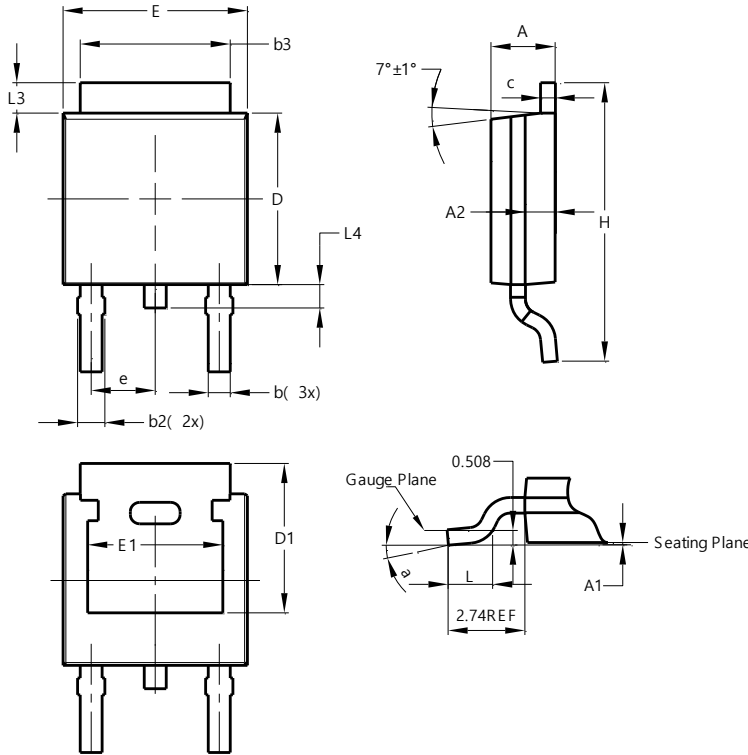


**Figure 12.  $V_{BE(sat)}$  v  $I_C$**

**Package Outline Dimensions**

Please see <http://www.diodes.com/package-outlines.html> for the latest version.

**TO252 (DPAK)**

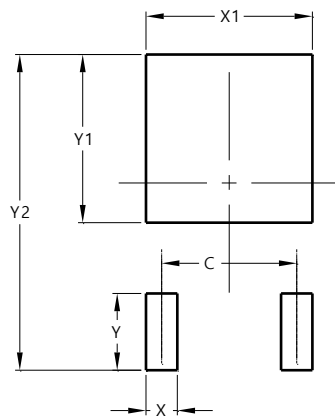


TO252 (DPAK)			
Dim	Min	Max	Typ
A	2.19	2.39	2.29
A1	0.00	0.13	0.08
A2	0.97	1.17	1.07
b	0.64	0.88	0.783
b2	0.76	1.14	0.95
b3	5.21	5.50	5.33
c	0.45	0.58	0.531
D	6.00	6.20	6.10
D1	5.21	--	--
e	2.286 BSC		
E	6.45	6.70	6.58
E1	4.32	--	--
H	9.40	10.41	9.91
L	1.40	1.78	1.59
L3	0.88	1.27	1.08
L4	0.64	1.02	0.83
a	0°	10°	--
<b>All Dimensions in mm</b>			

**Suggested Pad Layout**

Please see <http://www.diodes.com/package-outlines.html> for the latest version.

**TO252 (DPAK)**



Dimensions	Value (in mm)
C	4.572
X	1.060
X1	5.632
Y	2.600
Y1	5.700
Y2	10.700

**IMPORTANT NOTICE**

1. DIODES INCORPORATED (Diodes) AND ITS SUBSIDIARIES MAKE NO WARRANTY OF ANY KIND, EXPRESS OR IMPLIED, WITH REGARDS TO ANY INFORMATION CONTAINED IN THIS DOCUMENT, INCLUDING, BUT NOT LIMITED TO, THE IMPLIED WARRANTIES OF MERCHANTABILITY, FITNESS FOR A PARTICULAR PURPOSE OR NON-INFRINGEMENT OF THIRD PARTY INTELLECTUAL PROPERTY RIGHTS (AND THEIR EQUIVALENTS UNDER THE LAWS OF ANY JURISDICTION).
2. The Information contained herein is for informational purpose only and is provided only to illustrate the operation of Diodes' products described herein and application examples. Diodes does not assume any liability arising out of the application or use of this document or any product described herein. This document is intended for skilled and technically trained engineering customers and users who design with Diodes' products. Diodes' products may be used to facilitate safety-related applications; however, in all instances customers and users are responsible for (a) selecting the appropriate Diodes products for their applications, (b) evaluating the suitability of Diodes' products for their intended applications, (c) ensuring their applications, which incorporate Diodes' products, comply the applicable legal and regulatory requirements as well as safety and functional-safety related standards, and (d) ensuring they design with appropriate safeguards (including testing, validation, quality control techniques, redundancy, malfunction prevention, and appropriate treatment for aging degradation) to minimize the risks associated with their applications.
3. Diodes assumes no liability for any application-related information, support, assistance or feedback that may be provided by Diodes from time to time. Any customer or user of this document or products described herein will assume all risks and liabilities associated with such use, and will hold Diodes and all companies whose products are represented herein or on Diodes' websites, harmless against all damages and liabilities.
4. Products described herein may be covered by one or more United States, international or foreign patents and pending patent applications. Product names and markings noted herein may also be covered by one or more United States, international or foreign trademarks and trademark applications. Diodes does not convey any license under any of its intellectual property rights or the rights of any third parties (including third parties whose products and services may be described in this document or on Diodes' website) under this document.
5. Diodes' products are provided subject to Diodes' Standard Terms and Conditions of Sale (<https://www.diodes.com/about/company/terms-and-conditions/terms-and-conditions-of-sales/>) or other applicable terms. This document does not alter or expand the applicable warranties provided by Diodes. Diodes does not warrant or accept any liability whatsoever in respect of any products purchased through unauthorized sales channel.
6. Diodes' products and technology may not be used for or incorporated into any products or systems whose manufacture, use or sale is prohibited under any applicable laws and regulations. Should customers or users use Diodes' products in contravention of any applicable laws or regulations, or for any unintended or unauthorized application, customers and users will (a) be solely responsible for any damages, losses or penalties arising in connection therewith or as a result thereof, and (b) indemnify and hold Diodes and its representatives and agents harmless against any and all claims, damages, expenses, and attorney fees arising out of, directly or indirectly, any claim relating to any noncompliance with the applicable laws and regulations, as well as any unintended or unauthorized application.
7. While efforts have been made to ensure the information contained in this document is accurate, complete and current, it may contain technical inaccuracies, omissions and typographical errors. Diodes does not warrant that information contained in this document is error-free and Diodes is under no obligation to update or otherwise correct this information. Notwithstanding the foregoing, Diodes reserves the right to make modifications, enhancements, improvements, corrections or other changes without further notice to this document and any product described herein. This document is written in English but may be translated into multiple languages for reference. Only the English version of this document is the final and determinative format released by Diodes.
8. Any unauthorized copying, modification, distribution, transmission, display or other use of this document (or any portion hereof) is prohibited. Diodes assumes no responsibility for any losses incurred by the customers or users or any third parties arising from any such unauthorized use.
9. This Notice may be periodically updated with the most recent version available at <https://www.diodes.com/about/company/terms-and-conditions/important-notice>

The Diodes logo is a registered trademark of Diodes Incorporated in the United States and other countries.  
All other trademarks are the property of their respective owners.  
© 2024 Diodes Incorporated. All Rights Reserved.

[www.diodes.com](http://www.diodes.com)