

SOTiny™ LVDS High-Speed Differential Line Driver

Features

- Meets or Exceeds ANSI TIA/EIA-644-1955 Standard
- Signaling Rates Up to 660 Mbps
- Bus-Terminal ESD exceeds 2kV
- Low-Voltage Differential Signaling with typical Output Voltages of 350mV:
 - 100Ω load
- Typical Propagation Delay Times of 1.5ns
- Typical Power Dissipation of 20mW @200 MHz
- Low-Voltage TTL (LVTTTL) Level is 5V Tolerant
- Operates from a 3.3V supply
- Extended Industrial Temperature Operating Range: -40°C to 105°C
- Totally Lead-Free & Fully RoHS Compliant (Notes 1 & 2)
- Halogen and Antimony Free. “Green” Device (Note 3)
- For automotive applications requiring specific change control (i.e. parts qualified to AEC-Q100/101/104/200, PPAP capable, and manufactured in IATF 16949 certified facilities), please [contact us](mailto:contact@diodes.com) or your local Diodes representative. <https://www.diodes.com/quality/product-definitions/>
- Packaging (Pb-free & Green available):
 - 5-pin space-saving SOT23 (T)

Description

The DIODES™ PI90LV01A is differential line driver that uses low-voltage differential signaling (LVDS) to support data rates up to 660 Mbps. This device is designed for applications requiring high-speed, low-power consumption, low-noise generation, and a small package.

The TIA/EIA-644 standard compliant electrical interface provides a minimum differential output voltage magnitude of 247mV into a 100-ohm load and receipt of 100mV signals with up to 1V of ground potential difference between a transmitter and receiver.

A low-voltage TTL/CMOS input level is translated by the device into a low-voltage (350mV) differential output signal.

Application(s)

Applications include point-to-point (single termination) and multi-point (double termination) baseband data transmissions over controlled impedance media. The transmission media can be printed circuit board traces, backplanes, or cables.

The PI90LV01A and companion line receivers (The DIODES™ PI90LV02A) provide new alternatives to RS-232, PECL and ECL devices for high-speed, point-to-point interface applications.

Logic Diagram

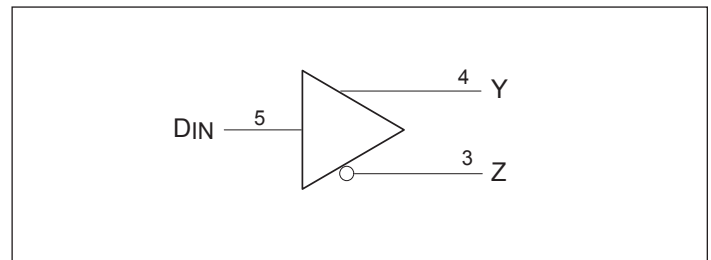

Notes:

1. No purposely added lead. Fully EU Directive 2002/95/EC (RoHS), 2011/65/EU (RoHS 2) & 2015/863/EU (RoHS 3) compliant.
2. See <https://www.diodes.com/quality/lead-free/> for more information about Diodes Incorporated’s definitions of Halogen- and Antimony-free, “Green” and Lead-free.
3. Halogen- and Antimony-free “Green” products are defined as those which contain <900ppm bromine, <900ppm chlorine (<1500ppm total Br + Cl) and <1000ppm antimony compounds.

DIODES is a trademark of Diodes Incorporated in the United States and other countries.

The Diodes logo is a registered trademark of Diodes Incorporated in the United States and other countries.

Pin Configuration

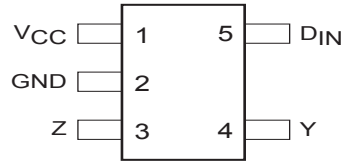

Function Table

Inputs	Outputs	
	Y	Z
D _{IN}	Y	Z
H	H	L
L	L	H
Open	L	H

Notes:

- H = High
- L = Low
- X = High or Low
- High Z = High Impedance

Absolute Maximum Ratings

(Over Operating Free-Air Temperature, unless otherwise noted)[†]

Supply Voltage Range, VCC(1).....	-0.5V to 4V
Input Voltage Range (DIN)	-0.5 to 6V
(Y or Z)	-0.5 to 4V
ESD Rating (HBM, 1.5KΩ, 100pF).....	≥ 2KV
Continuous Total Power Dissipation	See Dissipation Rating Table
Storage Temperature Range	-65°C to 150°C
Lead Temperature 1.6 mm (1/16 inch) from case for 10 seconds ..	250°C

Note:

Stresses greater than those listed under MAXIMUM RATINGS may cause permanent damage to the device. This is a stress rating only and functional operation of the device at these or any other conditions above those indicated in the operational sections of this specification is not implied. Exposure to absolute maximum rating conditions for extended periods may affect reliability.

1. All voltage values, except differential I/O bus voltages, are with respect to ground terminal.

Dissipation Rating Table

Package	T _A ≤ 25°C Power Rating	Derating Factor Above T _A = 25°C*	T _A = 85°C Power Rating
T	385mW	3.1mW/°C	200mW

*This is the inverse of the junction-to-ambient thermal resistance when board-mounted (low-K) and with no air flow.

Recommended Operating Conditions

Symbol	Parameter	Min.	Nom.	Max.	Units
V _{CC}	Supply Voltage	3.0	3.3	3.6	V
V _{IH}	High-Level Input Voltage	2		3.8	
V _{IL}	Low-Level Input Voltage			0.8	
T _A	Operating free-air temperature	-40		105	°C

Electrical Characteristics (Over Operating Free-Air Temperature, unless otherwise noted)

Symbol	Parameter	Test Conditions	Min.	Typ. ⁽¹⁾	Max.	Units
$ V_{OD} $	Differential output voltage magnitude	$R_L = 100\Omega$ See Figure 1	247	350	454	mV
$\Delta V_{OD} $	Change in differential output voltage magnitude between logic states		-50		50	
$V_{OC(SS)}$	Steady-state common-mode output voltage	See Figure 2	1.125		1.375	V
$\Delta V_{OC(SS)}$	Change in steady-state common-mode output voltage between logic states		-50		50	mV
$V_{OC(PP)}$	Peak-to-peak common-mode output voltage			25	100	
I_{CC}	Supply current	$V_I = 0V$ or V_{CC} , No Load		2	5.5	mA
		$V_I = 0V$ or V_{CC} , $R_L = 100\Omega$		5.5	8	
I_{IH}	High-level input current	$V_{IH} = 5V$		2	20	μA
I_{IL}	Low-level input current	$V_{IL} = 0.8V$		2	10	
I_{OS}	Short-circuit output current	V_{ODOUT+} or $V_{ODOUT-} = 0V$		3	10	mA
		$V_{OD} = 0V$			10	mA
$I_{O(OFF)}$	Power-off output current	$V_{CC} = 0V$, $V_O = 3.6V$			± 1	μA
C_{IN}	Input capacitance			3		pF

Note:

1. All typical values are at 25°C and with a 3.3V

Switching Characteristics, $V_{CC} = 3V$ to $3.6V$ (Over Operating Free-Air Temperature, unless otherwise noted)

Symbol	Parameter	Test Conditions	Min	Typ. ⁽¹⁾	Max.	Units
t_{PLH}	Propagation delay time, low-to-high level output	$R_L = 100\Omega$, $C_L = 10pF$ See Figure 3		1.5	2.7	ns
t_{PHL}	Propagation delay time, high-to-low level output			1.8	2.7	ns
t_r	Transition, low-to-high			0.6	1.5	ns
t_f	Transition, high-to-low			0.7	1.5	ns
$t_{sk(p)}$	Pulse skew ($ t_{PHL} - t_{PLH} $) ⁽²⁾			0.3		ns

Notes:

1. All typical values are at 25°C and with a 3.3V supply
2. $t_{sk(p)}$ is the magnitude of the time difference between the high-to-low and low-to-high propagation delay times at an output
3. f_{max} generator input conditions: 50% duty cycle, 0V to 3V. Output criteria: 45% to 55% duty cycle, $V_{OD} = 250mV$

Parameter Measurement Information

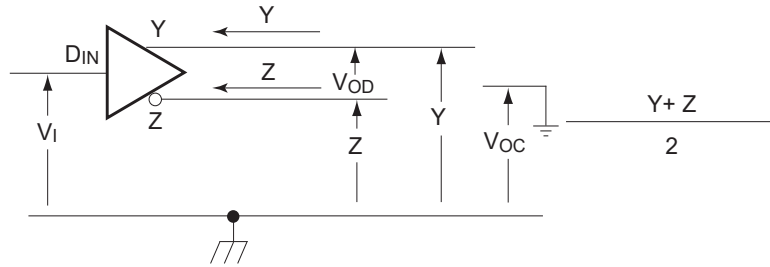

Figure 1. Driver Voltage and Current Definitions

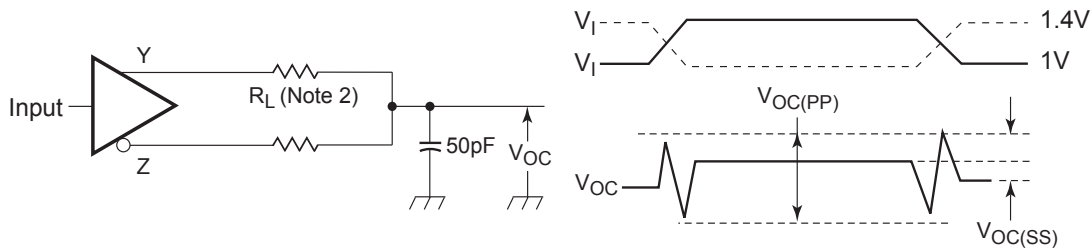
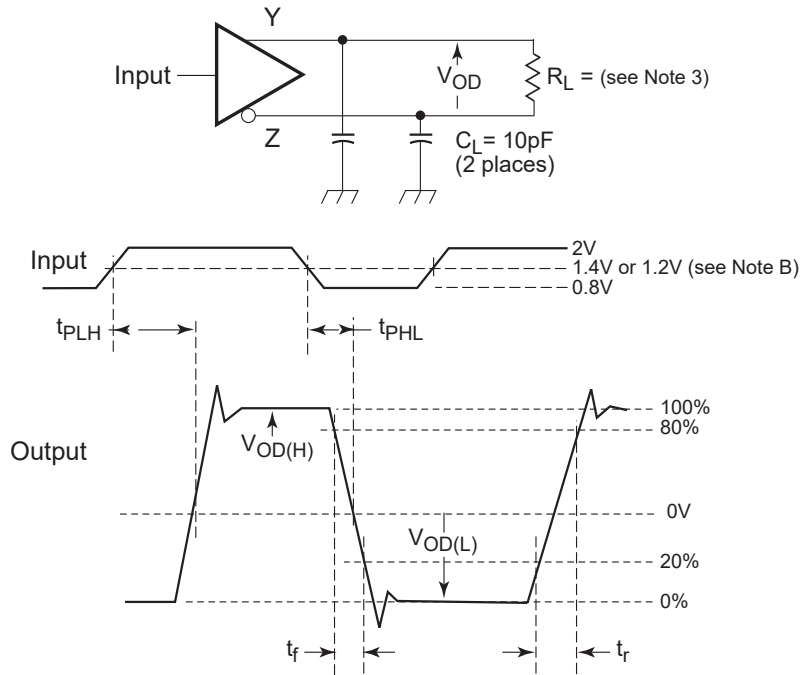

Figure 2. Test Circuit and Definitions for the Driver Common-Mode Output Voltage

Note:

- All input pulses are supplied by a generator having the following characteristics: t_r or $t_f \leq 1\text{ns}$, Pulse Repetition Rate (PRR) = 0.5 Mpps, Pulse width = $500 \pm 10\text{ns}$. C_L includes instrumentation and fixture capacitance within 0.06mm of the D.U.T. The measurement of $V_{OC(PP)}$ is made on test equipment with a -3dB bandwidth of at least 300MHz.
- $R_L = 49.9\Omega \pm 1\%$



Note:

1. All input pulses are supplied by a generator having the following characteristics: t_r or $t_f \leq 1$ ns, Pulse Repetition Rate (PRR) = 50 Mpps, Pulse width = 10 ± 0.2 ns. CL includes instrumentation and fixture capacitance within 0.06m of the D.U.T.
2. This point is 1.4V with $V_{CC} = 3.3$ V
3. $R_L = 100$ ohms for PI90LV01A.

Figure 3. Test Circuit, Timing, & Voltage Definitions for the Differential Output Signal

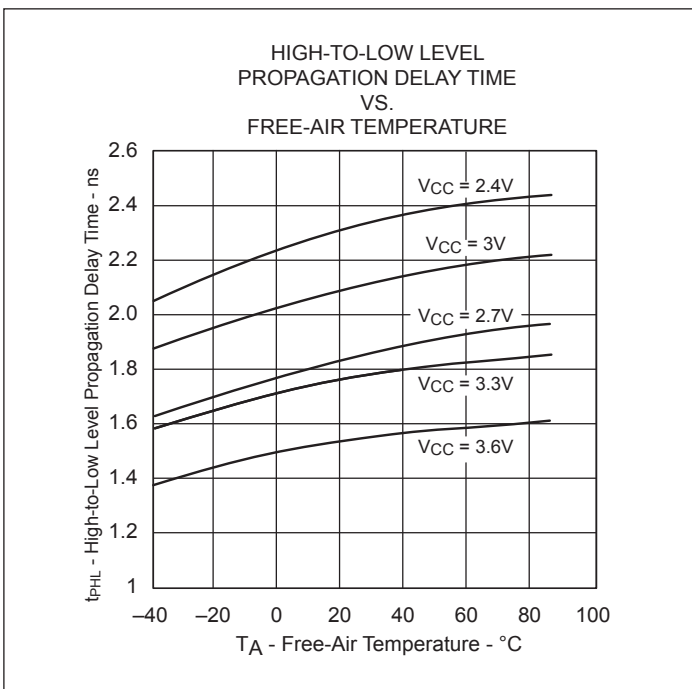

Figure 4.

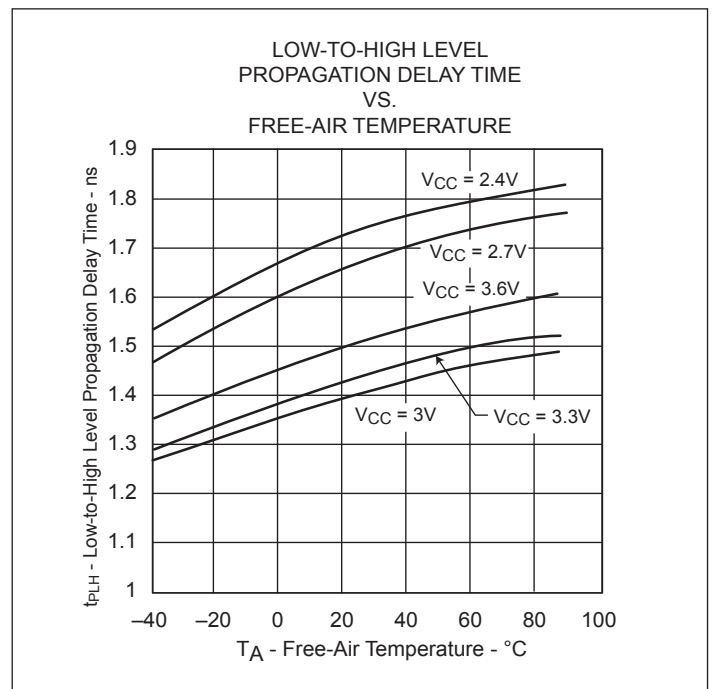

Figure 5.

PI90LV01A

Part Marking



GA: PI90LV01ATE

Y: Date Code (Year)

W: Date Code (Workweek)

Line above "G" denotes Pb-free and green

Packaging Mechanical

5-SOT23 (T)

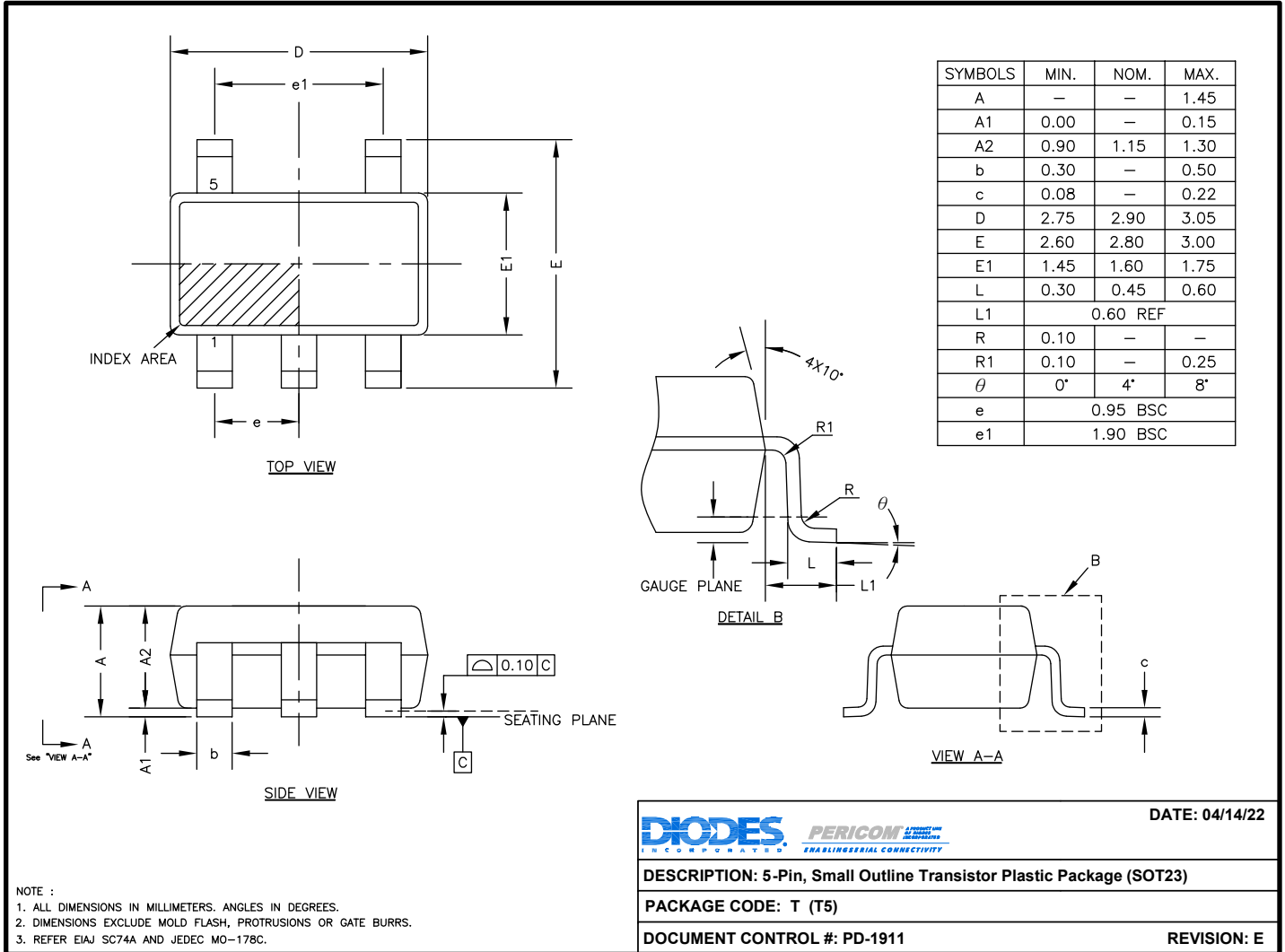

For latest package info.

please check: <http://www.diodes.com/design/support/packaging/pericom-packaging/packaging-mechanicals-and-thermal-characteristics/>

Ordering Information

Ordering Number	Package Code	Package Description	Top Marking
PI90LV01ATEX	T	5-Pin, Small Outline Transistor Plastic Package (SOT23)	$\overline{\text{GA}}$

Notes:

1. No purposely added lead. Fully EU Directive 2002/95/EC (RoHS), 2011/65/EU (RoHS 2) & 2015/863/EU (RoHS 3) compliant.
2. See <https://www.diodes.com/quality/lead-free/> for more information about Diodes Incorporated's definitions of Halogen- and Antimony-free, "Green" and Lead-free.
3. Halogen- and Antimony-free "Green" products are defined as those which contain <900ppm bromine, <900ppm chlorine (<1500ppm total Br + Cl) and <1000ppm antimony compounds.
4. E = Pb-free and Green
5. X suffix = Tape/Reel

IMPORTANT NOTICE

1. DIODES INCORPORATED (Diodes) AND ITS SUBSIDIARIES MAKE NO WARRANTY OF ANY KIND, EXPRESS OR IMPLIED, WITH REGARDS TO ANY INFORMATION CONTAINED IN THIS DOCUMENT, INCLUDING, BUT NOT LIMITED TO, THE IMPLIED WARRANTIES OF MERCHANTABILITY, FITNESS FOR A PARTICULAR PURPOSE OR NON-INFRINGEMENT OF THIRD PARTY INTELLECTUAL PROPERTY RIGHTS (AND THEIR EQUIVALENTS UNDER THE LAWS OF ANY JURISDICTION),

2. The Information contained herein is for informational purpose only and is provided only to illustrate the operation of Diodes' products described herein and application examples. Diodes does not assume any liability arising out of the application or use of this document or any product described herein. This document is intended for skilled and technically trained engineering customers and users who design with Diodes' products. Diodes' products may be used to facilitate safety-related applications; however, in all instances customers and users are responsible for (a) selecting the appropriate Diodes products for their applications, (b) evaluating the suitability of Diodes' products for their intended applications, (c) ensuring their applications, which incorporate Diodes' products, comply the applicable legal and regulatory requirements as well as safety and functional-safety related standards, and (d) ensuring they design with appropriate safeguards (including testing, validation, quality control techniques, redundancy, malfunction prevention, and appropriate treatment for aging degradation) to minimize the risks associated with their applications.

3. Diodes assumes no liability for any application-related information, support, assistance or feedback that may be provided by Diodes from time to time. Any customer or user of this document or products described herein will assume all risks and liabilities associated with such use, and will hold Diodes and all companies whose products are represented herein or on Diodes' websites, harmless against all damages and liabilities.

4. Products described herein may be covered by one or more United States, international or foreign patents and pending patent applications. Product names and markings noted herein may also be covered by one or more United States, international or foreign trademarks and trademark applications. Diodes does not convey any license under any of its intellectual property rights or the rights of any third parties (including third parties whose products and services may be described in this document or on Diodes' website) under this document.

5. Diodes' products are provided subject to Diodes' Standard Terms and Conditions of Sale (<https://www.diodes.com/about/company/terms-and-conditions/terms-and-conditions-of-sales/>) or other applicable terms. This document does not alter or expand the applicable warranties provided by Diodes. Diodes does not warrant or accept any liability whatsoever in respect of any products purchased through unauthorized sales channel.

6. Diodes' products and technology may not be used for or incorporated into any products or systems whose manufacture, use or sale is prohibited under any applicable laws and regulations. Should customers or users use Diodes' products in contravention of any applicable laws or regulations, or for any unintended or unauthorized application, customers and users will (a) be solely responsible for any damages, losses or penalties arising in connection therewith or as a result thereof, and (b) indemnify and hold Diodes and its representatives and agents harmless against any and all claims, damages, expenses, and attorney fees arising out of, directly or indirectly, any claim relating to any noncompliance with the applicable laws and regulations, as well as any unintended or unauthorized application.

7. While efforts have been made to ensure the information contained in this document is accurate, complete and current, it may contain technical inaccuracies, omissions and typographical errors. Diodes does not warrant that information contained in this document is error-free and Diodes is under no obligation to update or otherwise correct this information. Notwithstanding the foregoing, Diodes reserves the right to make modifications, enhancements, improvements, corrections or other changes without further notice to this document and any product described herein. This document is written in English but may be translated into multiple languages for reference. Only the English version of this document is the final and determinative format released by Diodes.

8. Any unauthorized copying, modification, distribution, transmission, display or other use of this document (or any portion hereof) is prohibited. Diodes assumes no responsibility for any losses incurred by the customers or users or any third parties arising from any such unauthorized use.

9. This Notice may be periodically updated with the most recent version available at <https://www.diodes.com/about/company/terms-and-conditions/important-notice>

DIODES is a trademark of Diodes Incorporated in the United States and other countries.

The Diodes logo is a registered trademark of Diodes Incorporated in the United States and other countries.

© 2022 Diodes Incorporated. All Rights Reserved.

www.diodes.com