

Product Summary

V_{RRM} (V)	I_o (A)	V_F Max (V)	I_r Max (μA)
40	0.5	0.55	10

Description and Applications

The SDT05U40CP3 is a 40-volt 0.5A trench Schottky barrier rectifier that is optimized for low-forward voltage drop and low-leakage current, housed in a compact chip-scale package (CSP) that occupies only 0.18mm² board space with low profile. The low thermal resistance enables designers to meet design challenges of increasing efficiency whilst at the same time reducing board space. The SDT05U40CP3 are ideally suited for use in portable applications as:

- Blocking diodes
- Boost diodes
- Switching diodes
- Reverse protection diodes

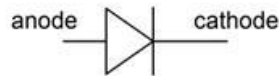

Device Schematic

Features and Benefits

- Low-forward voltage (V_F) minimizes conduction losses and improves efficiency.
- Low Leakage-Maximizes Battery Power
- Reduced high temperature reverse leakage; Increased reliability against thermal runaway failure in high temperature operation.
- **Totally Lead-Free & Fully RoHS Compliant (Notes 1 & 2)**
- **Halogen and Antimony Free. "Green" Device (Note 3)**
- **For automotive applications requiring specific change control (i.e. parts qualified to AEC-Q100/101/104/200, PPAP capable, and manufactured in IATF 16949 certified facilities), please [contact us](mailto:contact@diodes.com) or your local Diodes representative. <https://www.diodes.com/quality/product-definitions/>**

Mechanical Data

- Package: X3-DSN0603-2
- Moisture Sensitivity: Level 1 per J-STD-020
- Terminals: NiAu Bump. Solderable per MIL-STD-202, Method 208 (e4)
- Polarity: Cathode Dot
- Weight: 0.115mg (Approximate)

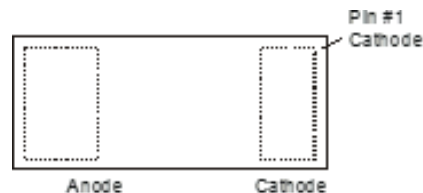

Ordering Information (Note 4)

Part Number	Package	Packing	
		Qty.	Carrier
SDT05U40CP3-7	X3-DSN0603-2	10,000	Tape & Reel

- Notes:
1. No purposely added lead. Fully EU Directive 2002/95/EC (RoHS), 2011/65/EU (RoHS 2) & 2015/863/EU (RoHS 3) compliant.
 2. See <https://www.diodes.com/quality/lead-free/> for more information about Diodes Incorporated's definitions of Halogen- and Antimony-free, "Green" and Lead-free.
 3. Halogen- and Antimony-free "Green" products are defined as those which contain <900ppm bromine, <900ppm chlorine (<1500ppm total Br + Cl) and <1000ppm antimony compounds.
 4. For packaging details, go to our website at <https://www.diodes.com/design/support/packaging/diodes-packaging/>.

Marking Information

Pin 1

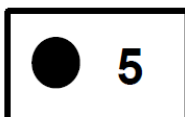

5 = Product Type Marking Code
Dot Denotes Cathode Pin

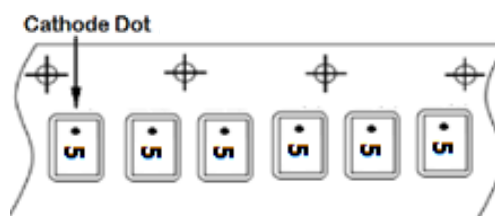

Maximum Ratings (@T_A = +25°C, unless otherwise specified.)

Single phase, half wave, 60Hz, resistive or inductive load.
For capacitive load, derate current by 20%.

Characteristic	Symbol	Value	Unit
Peak Repetitive Reverse Voltage	V _{RRM}	40	V
Average Rectified Output Current	I _o	0.5	A
Non-Repetitive Peak Forward Surge Current 8.3ms Single Half Sine Wave Superimposed on Rated Load	I _{FSM}	7	A
ESD (Human Body Model)	ESD	8	kV
ESD (Machine Model)		0.4	

Thermal Characteristics

Characteristic	Symbol	Value	Unit
Typical Thermal Resistance Junction to Ambient (Note 5)	R _{θJA}	220	°C/W
Typical Thermal Resistance Junction to Ambient (Note 6)	R _{θJA}	80	°C/W
Typical Thermal Resistance Junction to Case (Note 5)	R _{θJC}	35	°C/W
Typical Thermal Resistance Junction to Case (Note 6)	R _{θJC}	20	°C/W
Operating and Storage Temperature Range	T _J , T _{STG}	-55 to +150	°C

Electrical Characteristics (@T_A = +25°C, unless otherwise specified.)

Characteristic	Symbol	Min	Typ	Max	Unit	Test Condition
Forward Voltage Drop	V _F	—	0.26	0.33	V	I _F = 10mA, T _J = +25°C
		—	0.35	0.41		I _F = 100mA, T _J = +25°C
		—	0.39	0.47		I _F = 200mA, T _J = +25°C
		—	0.49	0.55		I _F = 500mA, T _J = +25°C
Reverse Current (Note 7)	I _R	—	2.7	10	μA	V _R = 40V, T _J = +25°C
		—	1.2	—	mA	V _R = 40V, T _J = +125°C
Junction Capacitance	C _T	—	18.8	—	pF	V _R = 10V, f = 1.0MHz

Notes: 5. Device mounted on FR-4 PCB, 2oz. copper, minimum recommended pad layout per <http://www.diodes.com/package-outlines.html>.
6. Device mounted on 1inch square copper pad, 2oz.
7. Short duration pulse test used to minimize self-heating effect.

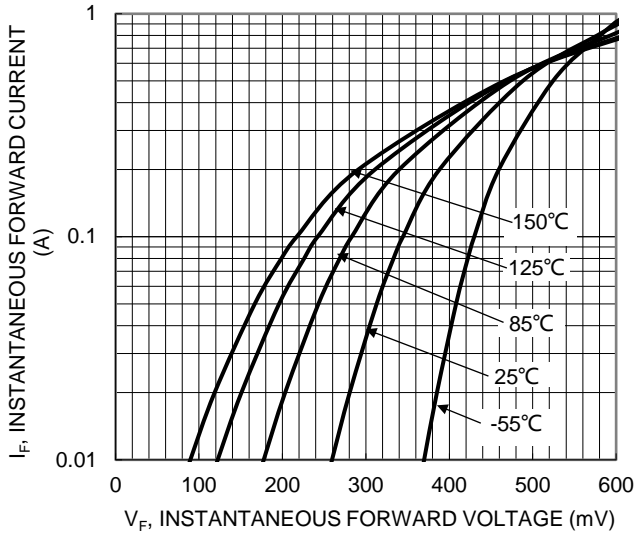

Figure 1. Typical Forward Characteristics

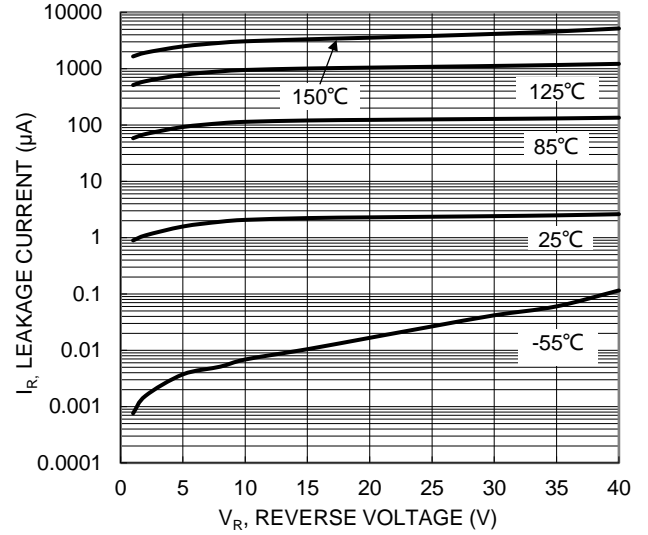

Figure 2. Typical Reverse Characteristics

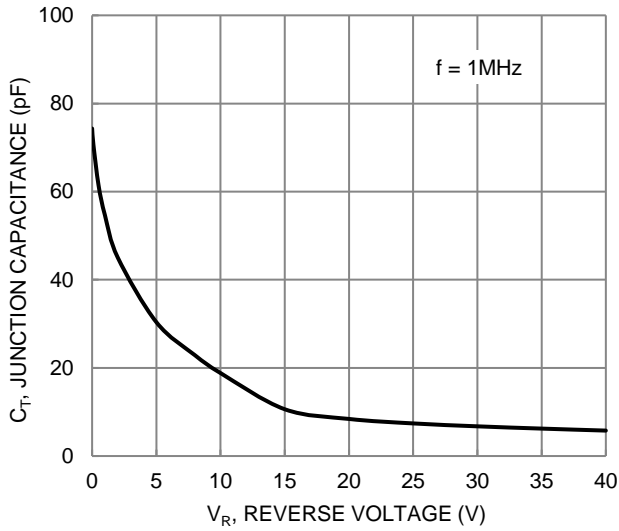

Figure 3. Typical Junction Capacitance

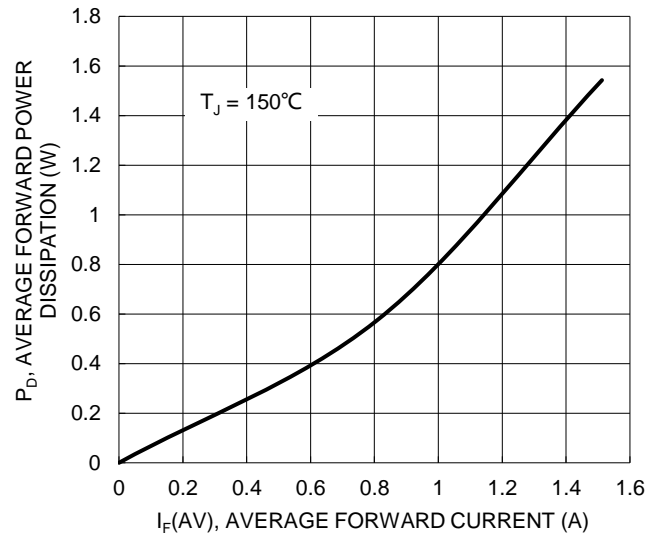
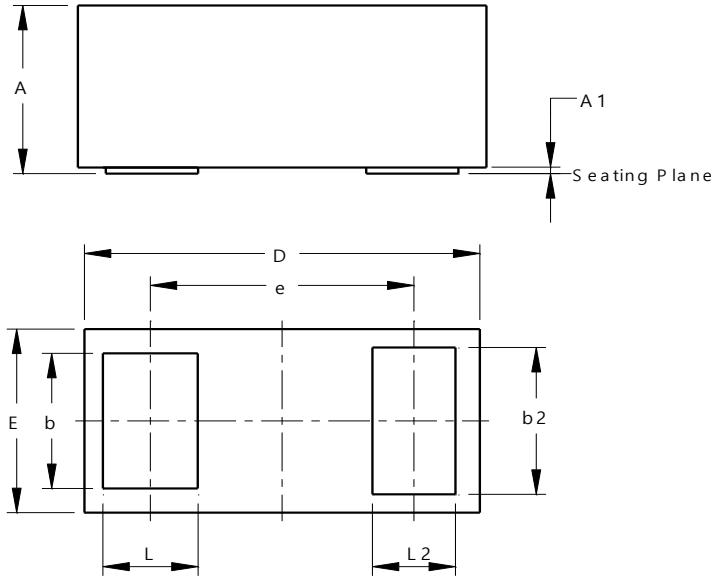

Figure 4. Forward Power Dissipation

Package Outline Dimensions (Note 8)

Please see <http://www.diodes.com/package-outlines.html> for the latest version.

X3-DSN0603-2



X3-DSN0603-2			
Dim	Min	Max	Typ
A	0.225	0.275	0.250
A1	0.00	0.02	--
b	0.196	0.246	0.221
b2	0.216	0.266	0.241
D	0.575	0.625	0.600
E	0.275	0.325	0.300
e	--	--	0.400
L	0.134	0.174	0.154
L2	0.116	0.156	0.136
All Dimensions in mm			

Note 8: Device side walls are electrically active bare silicon. Avoid contact of solder or flux on the side walls during the PCB assembly process.

Suggested Pad Layout

Please see <http://www.diodes.com/package-outlines.html> for the latest version.

X3-DSN0603-2

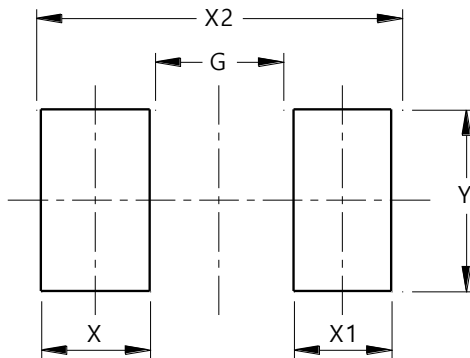

Dimensions	Value (in mm)
G	0.262
X	0.174
X1	0.156
X2	0.625
Y	0.276

IMPORTANT NOTICE

1. DIODES INCORPORATED (Diodes) AND ITS SUBSIDIARIES MAKE NO WARRANTY OF ANY KIND, EXPRESS OR IMPLIED, WITH REGARDS TO ANY INFORMATION CONTAINED IN THIS DOCUMENT, INCLUDING, BUT NOT LIMITED TO, THE IMPLIED WARRANTIES OF MERCHANTABILITY, FITNESS FOR A PARTICULAR PURPOSE OR NON-INFRINGEMENT OF THIRD PARTY INTELLECTUAL PROPERTY RIGHTS (AND THEIR EQUIVALENTS UNDER THE LAWS OF ANY JURISDICTION).
2. The Information contained herein is for informational purpose only and is provided only to illustrate the operation of Diodes' products described herein and application examples. Diodes does not assume any liability arising out of the application or use of this document or any product described herein. This document is intended for skilled and technically trained engineering customers and users who design with Diodes' products. Diodes' products may be used to facilitate safety-related applications; however, in all instances customers and users are responsible for (a) selecting the appropriate Diodes products for their applications, (b) evaluating the suitability of Diodes' products for their intended applications, (c) ensuring their applications, which incorporate Diodes' products, comply the applicable legal and regulatory requirements as well as safety and functional-safety related standards, and (d) ensuring they design with appropriate safeguards (including testing, validation, quality control techniques, redundancy, malfunction prevention, and appropriate treatment for aging degradation) to minimize the risks associated with their applications.
3. Diodes assumes no liability for any application-related information, support, assistance or feedback that may be provided by Diodes from time to time. Any customer or user of this document or products described herein will assume all risks and liabilities associated with such use, and will hold Diodes and all companies whose products are represented herein or on Diodes' websites, harmless against all damages and liabilities.
4. Products described herein may be covered by one or more United States, international or foreign patents and pending patent applications. Product names and markings noted herein may also be covered by one or more United States, international or foreign trademarks and trademark applications. Diodes does not convey any license under any of its intellectual property rights or the rights of any third parties (including third parties whose products and services may be described in this document or on Diodes' website) under this document.
5. Diodes' products are provided subject to Diodes' Standard Terms and Conditions of Sale (<https://www.diodes.com/about/company/terms-and-conditions/terms-and-conditions-of-sales/>) or other applicable terms. This document does not alter or expand the applicable warranties provided by Diodes. Diodes does not warrant or accept any liability whatsoever in respect of any products purchased through unauthorized sales channel.
6. Diodes' products and technology may not be used for or incorporated into any products or systems whose manufacture, use or sale is prohibited under any applicable laws and regulations. Should customers or users use Diodes' products in contravention of any applicable laws or regulations, or for any unintended or unauthorized application, customers and users will (a) be solely responsible for any damages, losses or penalties arising in connection therewith or as a result thereof, and (b) indemnify and hold Diodes and its representatives and agents harmless against any and all claims, damages, expenses, and attorney fees arising out of, directly or indirectly, any claim relating to any noncompliance with the applicable laws and regulations, as well as any unintended or unauthorized application.
7. While efforts have been made to ensure the information contained in this document is accurate, complete and current, it may contain technical inaccuracies, omissions and typographical errors. Diodes does not warrant that information contained in this document is error-free and Diodes is under no obligation to update or otherwise correct this information. Notwithstanding the foregoing, Diodes reserves the right to make modifications, enhancements, improvements, corrections or other changes without further notice to this document and any product described herein. This document is written in English but may be translated into multiple languages for reference. Only the English version of this document is the final and determinative format released by Diodes.
8. Any unauthorized copying, modification, distribution, transmission, display or other use of this document (or any portion hereof) is prohibited. Diodes assumes no responsibility for any losses incurred by the customers or users or any third parties arising from any such unauthorized use.
9. This Notice may be periodically updated with the most recent version available at <https://www.diodes.com/about/company/terms-and-conditions/important-notice>

The Diodes logo is a registered trademark of Diodes Incorporated in the United States and other countries.
All other trademarks are the property of their respective owners.
© 2023 Diodes Incorporated. All Rights Reserved.

www.diodes.com