

SOD323 SCHOTTKY BARRIER DIODES

**ZMS2800
ZMS2811
ZMS5800**

ISSUE 1 – NOVEMBER 1998 ☺

FEATURES

- * Miniature Surface Mount Packages
- * Low turn-on voltage
- * Pico second switching speed
- * High breakdown voltage

APPLICATIONS

- * Mixers
- * Detectors
- * Switching

PARTMARK

ZMS2800 - BA

ZMS2811 - BC

ZMS5800 - BB

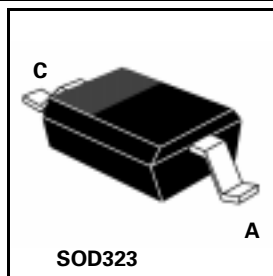

ABSOLUTE MAXIMUM RATINGS.

PARAMETER	SYMBOL	VALUE	UNIT
Forward Current (1 μ s pulse)	I_F	1	A
Power Dissipation at $T_{amb} = 25^\circ\text{C}$	P_{tot}	250	mW
Operating and Storage Temperature Range	$T_j; T_{stg}$	-55 to +150	$^\circ\text{C}$

ELECTRICAL CHARACTERISTICS (at $T_{amb} = 25^\circ\text{C}$).

PARAMETER	TYPE	SYMBOL	MIN.	TYP.	MAX.	UNIT	CONDITIONS.
Breakdown Voltage	ZMS2800 ZMS2811 ZMS5800	V_{BR}	70 15 50			V V V	$I_R = 10\mu\text{A}$
Reverse Leakage Current	ZMS2800 ZMS2811 ZMS5800	I_R			200 100 200	nA nA nA	$V_R = 50\text{V}$ $V_R = 10\text{V}$ $V_R = 35\text{V}$
Forward Voltage	ZMS2800 ZMS2811 ZMS5800	V_F			410 410 410	mV mV mV	$I_F = 1\text{mA}$
Forward Current	ZMS2800 ZMS2811 ZMS5800	I_F	15 20 15			mA mA mA	$V_F = 1\text{V}$
Capacitance	ZC2800E ZC2811E ZC5800E	C_T		1.2 1.0	2.0 1.2 2.0	pF pF pF	$V_R = 0\text{V}$, $f = 1\text{MHz}$
Effective Minority Lifetime (1)	ZC2800E ZC2811E ZC5800E	τ			100 100 100	ps ps ps	$f = 54\text{MHz}$ $I_{pk} = 20\text{mA}$

ZMS2800E
ZMS2811E
ZMS5800E

TYPICAL CHARACTERISTICS

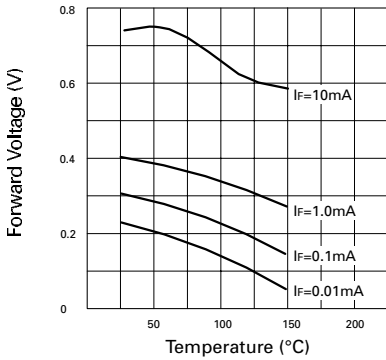

(ZMS2800 & ZMS5800)

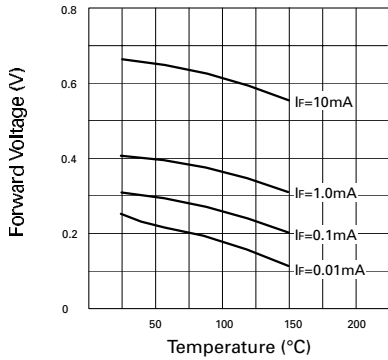

(ZMS2811)

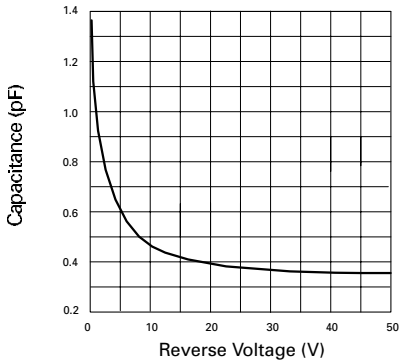

(ZMS2800 & ZMS5800)

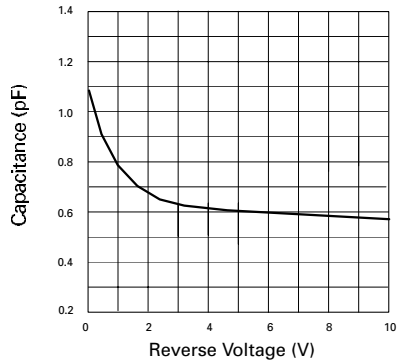

(ZMS2811)

**ZMS2800E
ZMS2811E
ZMS5800E**

TYPICAL CHARACTERISTICS

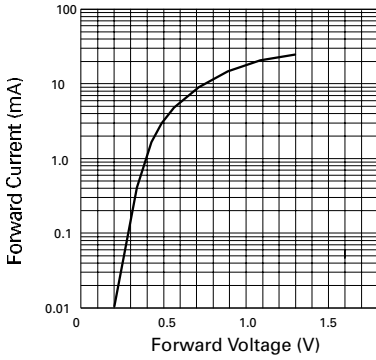

(ZMS2800 & ZMS5800)

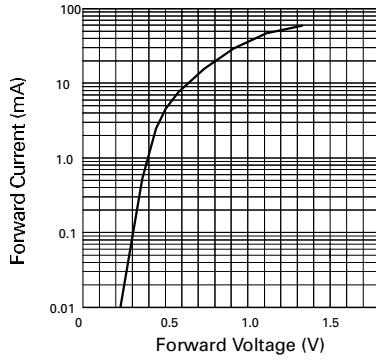

(ZMS2811)

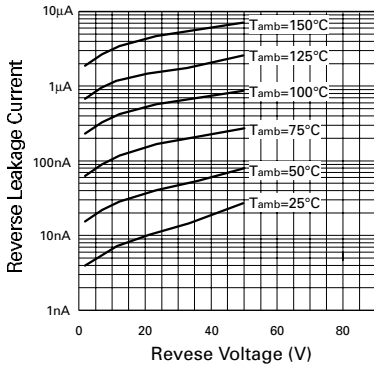

(ZMS2800 & ZMS5800)

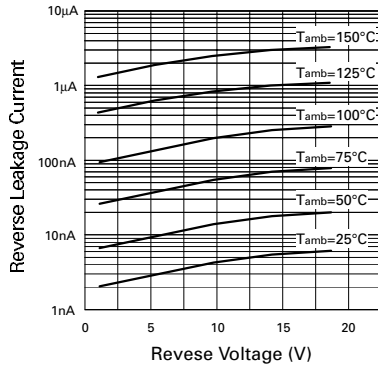

(ZMS2811)

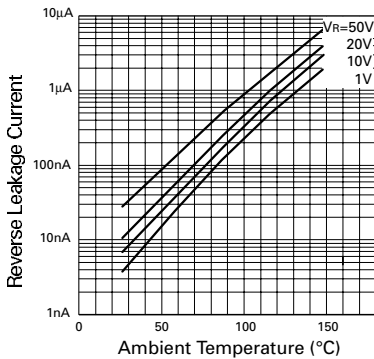

(ZMS2800 & ZMS5800)

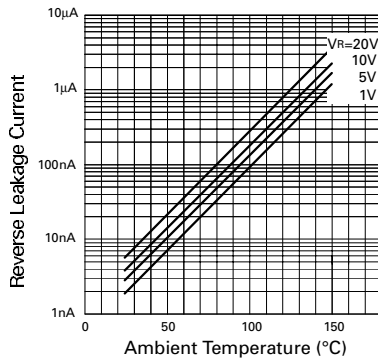

(ZMS2811)