

# PRECISION 2.45 VOLT VOLTAGE REFERENCE

# ZR458

ISSUE 2 — FEBRUARY 1998

## DEVICE DESCRIPTION

The ZR458 uses a bandgap circuit design to achieve a precision voltage reference of 2.45 volts.

The ZR458 design provides a stable voltage without an external capacitor and is stable with capacitive loads. The ZR458 is recommended for operation between 2mA and 120mA.

## FEATURES

- TO92 style package
- No stabilising capacitor required
- Typical  $T_C$  15ppm/°C
- Typical slope resistance 0.26Ω
- 1% tolerance
- Industrial temperature range (Military temperature range available on request)
- Operating current 2mA to 120mA
- Alternative package options and tolerances available

## APPLICATIONS

- Battery powered and portable equipment.
- Metering and measurement systems.
- Instrumentation.
- Test equipment.
- Data acquisition systems.

## SCHEMATIC DIAGRAM

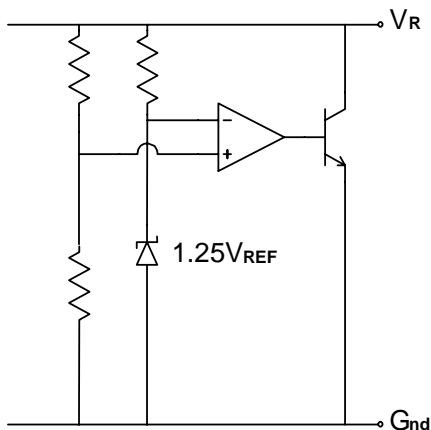

# ZR458

## ABSOLUTE MAXIMUM RATING

Reverse Current	200mA
Forward Current	25mA
Operating Temperature	-40 to 85°C
Storage Temperature	-55 to 125°C

**Power Dissipation (T<sub>amb</sub>=25°C)**  
E-Line, 2 pin (TO92)      500mW

## ELECTRICAL CHARACTERISTICS

**TEST CONDITIONS (Unless otherwise stated) T<sub>amb</sub>=25°C**

SYMBOL	PARAMETER	CONDITIONS	LIMITS			TOL. %	UNITS
			MIN	TYP	MAX		
V <sub>R</sub>	Reverse Breakdown Voltage	I <sub>R</sub> =5mA	2.43	2.45	2.47	1	V
I <sub>MIN</sub>	Minimum Operating Current				2		mA
I <sub>R</sub>	Recommended Operating Current		2		120		mA
T <sub>C</sub> †	Average Reverse Breakdown Voltage	ZR458		30	100		ppm/°C
	Temp. Co.	ZR458A	I <sub>R(min)</sub> to I <sub>R(max)</sub>	15	50		
R <sub>S</sub> §	Slope Resistance			0.26	0.5		Ω
Z <sub>R</sub>	Reverse Dynamic Impedance	I <sub>R</sub> = 5mA f = 100Hz I <sub>AC</sub> =0.1 I <sub>R</sub>		0.28	1		Ω
E <sub>N</sub>	Wideband Noise Voltage	I <sub>R</sub> = 5mA f = 10Hz to 10kHz		65			μV(rms)

$$\dagger T_C = \frac{(V_{R(max)} - V_{R(min)}) \times 1000000}{V_R \times (T_{(max)} - T_{(min)})}$$

Note: V<sub>R(max)</sub> - V<sub>R(min)</sub> is the maximum deviation in reference voltage measured over the full operating temperature range.

$$\S R_S = \frac{V_R \text{ Change}(I_R(\min) \text{ to } I_R(\max))}{I_R(\max) - I_R(\min)}$$

# ZR458

## TYPICAL CHARACTERISTICS

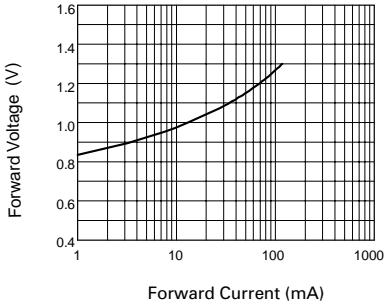

**Forward Characteristics**

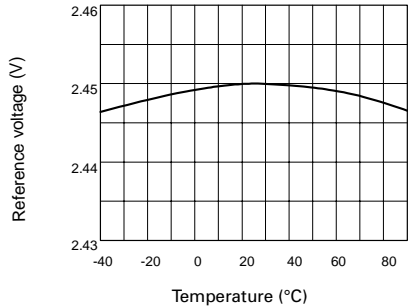

**Temperature Drift**

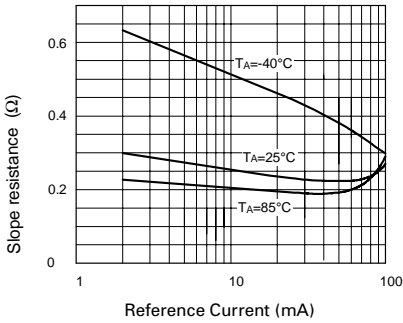

**Slope Resistance v Current**

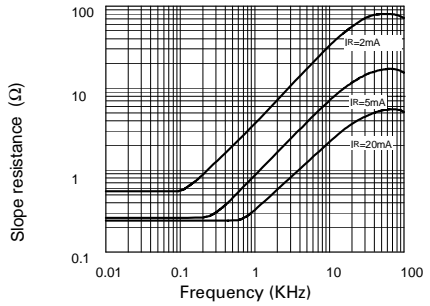

**Slope Resistance v Frequency**

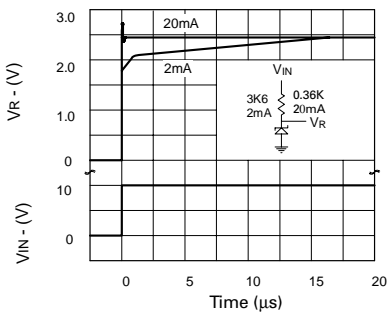

**Transient Response**

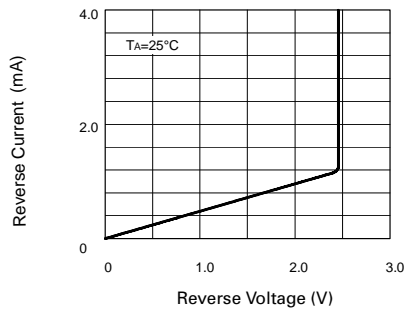

**Reverse Characteristics**

**ZR458**

## CONNECTION DIAGRAMS

E-Line, 2 pin, Package Suffix – Y

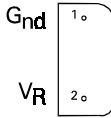

*Bottom View*

## ORDERING INFORMATION

Part No	Tol%	T <sub>C</sub> Option	Package	Partmark
ZR458	1	100ppm/ °C max	E-Line †	ZR458
ZR458A	1	50ppm/ °C max	E-Line †	ZR458A

† E-Line, 2 pin