

5 VOLT ENHANCED POSITIVE LOCAL VOLTAGE REGULATOR

ISSUE 1 - DECEMBER 1995

ZSAT500

DEVICE DESCRIPTION

The ZSAT500 is an enhanced three terminal fixed positive 5 volt regulator. The device is designed particularly for use in Satellite receiver low noise blocks where a high degree of supply rejection is required to extended frequencies. The device has been improved to give superior performance with ripple rejection of 65dB up to 22KHz, and 40dB up to 200KHz.

The device features internal circuit current limit and thermal shutdown making it almost impossible to destroy. The ZSAT500 shows performance characteristics superior to other local voltage regulators. The initial output voltage is maintained to within 2.5% with a quiescent current of typically 350 μ A. Line and load regulation is superior to that of other devices, with load current up to a maximum 200mA.

For the LNB application the regulator is offered in a surface mount SOT223 package which permits power dissipation up to 3 watts. Additionally the device can be made available in an SO8 surface mount package, as well as TO92 for through hole application.

The devices are suited to local voltage regulation applications, where problems could be encountered with distributed single source regulation, as well as more general voltage regulation applications.

FEATURES

- Enhanced ripple rejection - 65dB at 22kHz
- Small outline SO8 and SOT223 packages
- TO92 package
- 5 volt output
- Output current upto 200mA
- Tight initial tolerance
- Low quiescent current
- -55 to 125°C temperature range
- No external components
- Internal thermal shutdown
- Internal short circuit current limit

APPLICATIONS

- Satellite receivers
- Low noise blocks

SCHEMATIC DIAGRAM

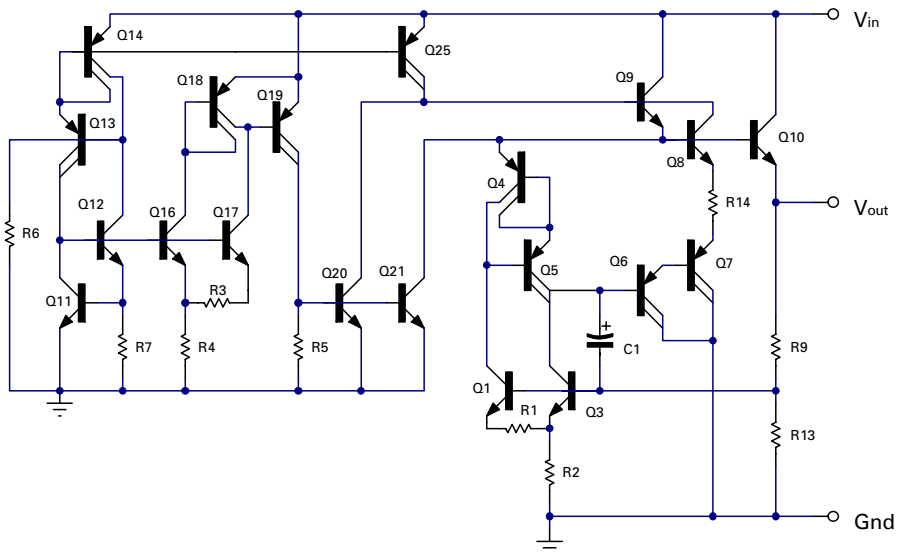

ZSAT500

ABSOLUTE MAXIMUM RATING

Input voltage	20V
Output Current(I _o)	200mA
Operating Temperature	-55 to 125°C
Storage Temperature	-65 to 150°C

Power Dissipation (T_{amb}=25°C)

SOT223	3W(Note 3)
TO92	600mW
SO8	780mW(Note 3)

ELECTRICAL CHARACTERISTICS

TEST CONDITIONS (Unless otherwise stated):T_j=25°C, I_O=100mA, V_{in}=9V

SYMBOL	PARAMETER	CONDITIONS	MIN.	TYP.	MAX.	UNITS
V _O	Output Voltage		4.875	5	5.125	V
		I _O =1 to 200mA T _j =-55 to 125°C	4.8		5.2	V
		V _{in} =7 to 20V I _O =1 to 100mA T _j =-55 to 125°C	4.8		5.2	V
ΔV _O	Line Regulation	V _{in} =7 to 20V		10	40	mV
ΔV _O	Load Regulation	I _O =1 to 200mA I _O =1 to 100mA		5 2	25	mV mV
I _q	Quiescent Current	T _j =-55 to 125°C		350	600	μA
ΔI _q	Quiescent Current Change	I _O =1 to 200mA V _{in} =7 to 20V			50 100	μA μA
V _n	Output Noise Voltage	f=10Hz to 10KHz		75		μV rms
ΔV _{in} /ΔV _O	Ripple Rejection	V _{in} =8 to 18V f=120Hz-22KHz	65			dB
ΔV _{in} /ΔV _O	Ripple Rejection	V _{in} =8 to 18V f=200KHz	40			dB
V _{in}	Input Voltage Required To Maintain Regulation		7	6.7		V
ΔV _O /ΔT	Average Temperature Coefficient of V _O	I _O =5.0mA T _j =-55 to 125°C		0.1		mV/°C
V _{GI}	Reverse Supply Protection Diode Forward Voltage	I _{GI} =500mA			2	V

ZSAT500

TYPICAL CHARACTERISTICS

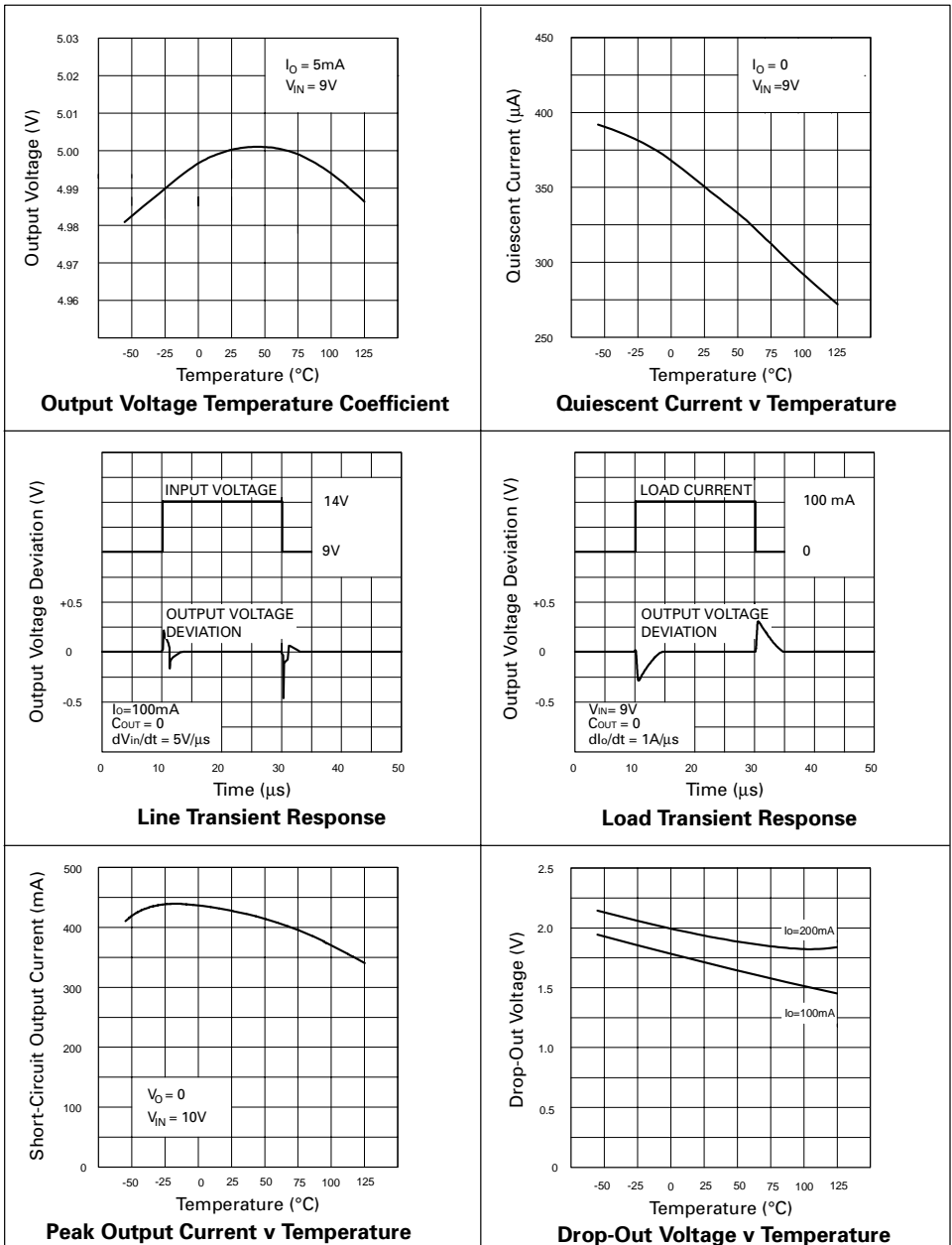

ZSAT500

TYPICAL CHARACTERISTICS

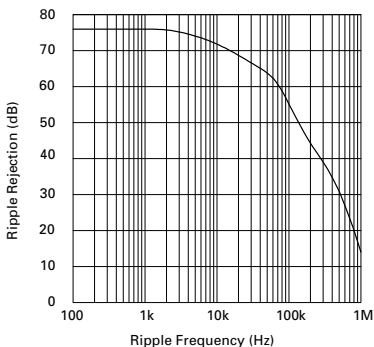

Ripple Rejection vs. Ripple Frequency

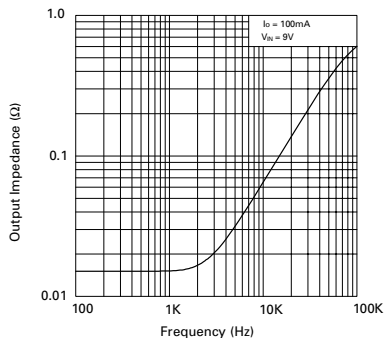

Output Impedance vs. Frequency

Notes:

1. The maximum operating input voltage and output current of the device will be governed by the maximum power dissipation of the selected package. Maximum package power dissipation is specified at 25 °C and must be linearly derated to zero at $T_{amb}=125^{\circ}\text{C}$.

2. The given data represents pulse test conditions with junction temperatures as indicated at the initiation of the test. Continuous operation of the devices with the stated conditions might exceed the power dissipation limits of the chosen package.

3. Maximum power dissipation, for the SO8 and SOT223 packages, is calculated assuming that the device is mounted on a PCB measuring 2 inches square.

4. The shut down feature of the device operates if its temperature exceeds its design limit as might occur during external faults, short circuits etc. If the regulator is supplied from an inductive source, a large voltage transient, on the regulator input, can result should the shut down circuit operate. It is advised that a capacitor (1 μF or greater) should be applied across the regulator input to ensure that the maximum voltage rating of the device is not exceeded under shutdown conditions.

5. HF Stability

The ZSAT500 is guaranteed stable without an input or output capacitor. However if an output capacitor is used then this should be a total value of at least 100nF and should be accompanied by an input capacitor of 200nF or greater, wired in close proximity to the regulator if stability is to be ensured.

ZSAT500

APPLICATIONS

Fixed Output Regulator

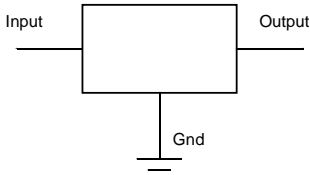

Adjustable Output Regulator

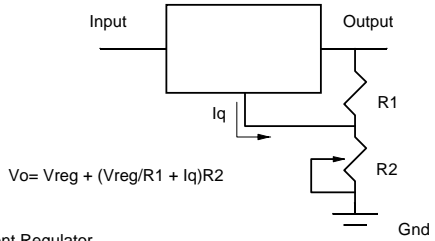

Current Regulator

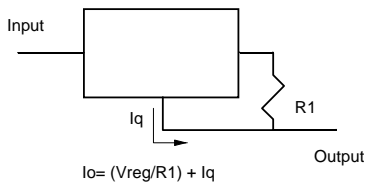

ZSAT500

CONNECTION DIAGRAMS

SO8 Package Suffix – N8

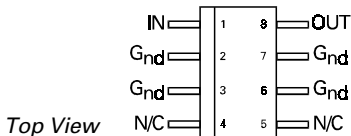

SOT223 Package Suffix – G

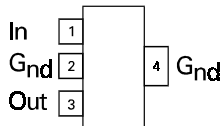

Top View –
Pin 4 floating or connected to pin 2

TO92 Package Suffix – C

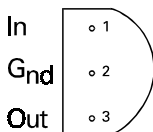

Bottom View

ORDERING INFORMATION

Part Number	Package	Part Mark
ZSAT500N8	SO8	ZSAT500
ZSAT500G	SOT223	ZSAT500
ZSAT500C	TO92	ZSAT500