

200V P-CHANNEL ENHANCEMENT MODE MOSFET

Product Summary

BV_{DSS}	$R_{DS(ON) MAX}$	$I_{D MAX}$ $T_A = +25^{\circ}C$
-200V	28Ω @ $V_{GS} = -10V$	-122mA

Description

This new generation trench MOSFET features a unique structure combining the benefits of low on-resistance and fast switching, making it ideal for high-efficiency power management applications.

Applications

- Active Clamping of Primary Side MOSFETs in 48V DC-DC Converters

Features and Benefits

- High Voltage
- Low On-Resistance
- Fast Switching Speed
- Low Gate Drive
- Low Threshold
- Totally Lead-Free & Fully RoHS Compliant (Notes 1 & 2)**
- Halogen and Antimony Free. "Green" Device (Note 3)**
- Qualified to AEC-Q101 Standards for High Reliability**

Mechanical Data

- Case: SOT25
- Case Material: Molded Plastic, "Green" Molding Compound. UL Flammability Classification Rating 94V-0
- Moisture Sensitivity: Level 1 per J-STD-020
- Terminals: Matte Tin Finish (e3)
- Weight: 0.016 grams (Approximate)



Top View

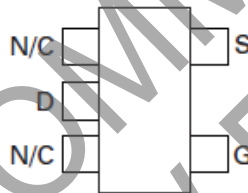

Pin Out - Top View

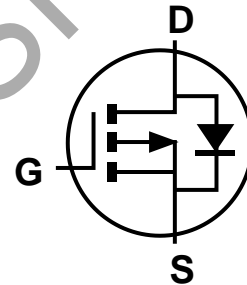

Equivalent Circuit

Ordering Information (Note 4)

Part Number	Marking	Reel Size (inches)	Tape Width (mm)	Quantity per Reel
ZXMP2120E5TA	P120	7	8	3,000

- Notes:
- No purposely added lead. Fully EU Directive 2002/95/EC (RoHS), 2011/65/EU (RoHS 2) & 2015/863/EU (RoHS 3) compliant.
 - See http://www.diodes.com/quality/lead_free/ for more information about Diodes Incorporated's definitions of Halogen- and Antimony-free, "Green" and Lead-free.
 - Halogen- and Antimony-free "Green" products are defined as those which contain <900ppm bromine, <900ppm chlorine (<1500ppm total Br + Cl) and <1000ppm antimony compounds.
 - For packaging details, go to our website at <https://www.diodes.com/design/support/packaging/diodes-packaging/>.

Marking Information

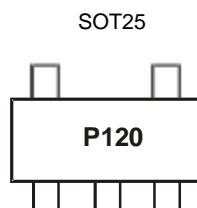

P120 = Product Type Marking Code

Maximum Ratings (@T_A = +25°C, unless otherwise specified.)

Characteristic	Symbol	Value	Unit
Drain-Source Voltage	V _{DSS}	-200	V
Gate-Source Voltage	V _{GSS}	±20	V
Continuous Drain Current (V _{GS} = -10V; T _A = +25°C) (Note 5)	I _D	-122	mA
Pulsed Drain Current (Note 6)	I _{DM}	-0.7	A
Pulsed Source Current (Body Diode) (Note 6)	I _{SM}	-0.7	A

Thermal Characteristics (@T_A = +25°C, unless otherwise specified.)

Characteristic	Symbol	Value	Unit
Power Dissipation at T _A = +25°C (Note 5)	P _D	0.75	W
Linear Derating Factor		6	mW/°C
Thermal Resistance, Junction to Ambient (Note 5)	R _{θJA}	167	°C/W
Operating and Storage Temperature Range	T _J , T _{STG}	-55 to +150	°C

Electrical Characteristics (@T_A = +25°C, unless otherwise specified.)

Characteristic	Symbol	Min	Typ	Max	Unit	Test Condition
OFF CHARACTERISTICS						
Drain-Source Breakdown Voltage	BV _{DSS}	-200	-	-	V	V _{GS} = 0V, I _D = -1mA
Zero Gate Voltage Drain Current	I _{DSS}	-	-	-10 -100	µA	V _{DS} = -200V, V _{GS} = 0V V _{DS} = -160V, V _{GS} = 0V, T _A = +125°C
Gate-Source Leakage	I _{GSS}	-	-	20	nA	V _{GS} = ±20V, V _{DS} = 0V
ON CHARACTERISTICS						
Gate Threshold Voltage	V _{GS(TH)}	-1.5	-	-3.5	V	V _{DS} = V _{GS} , I _D = -1mA
Static Drain-Source On-Resistance (Note 7)	R _{DS(ON)}	-	-	28	Ω	V _{GS} = -10V, I _D = -150mA
Forward Transconductance (Notes 7 & 8)	g _{fs}	50	-	-	ms	V _{DS} = -25V, I _D = -150mA
On-State Drain Current (Note 7)	I _{D(ON)}	-300	-	-	mA	V _{DS} = -25V, V _{GS} = -10V
DYNAMIC CHARACTERISTICS						
Input Capacitance (Note 8)	C _{iss}	-	-	100	pF	V _{DS} = -25V, V _{GS} = 0V, f = 1.0MHz
Output Capacitance (Note 8)	C _{oss}	-	-	25	pF	
Reverse Transfer Capacitance (Note 8)	C _{rss}	-	-	7	pF	
Turn-On Delay Time (Notes 8 & 9)	t _{D(ON)}	-	-	7	ns	V _{DD} = -25V, I _D = -150mA
Turn-On Rise Time (Notes 8 & 9)	t _R	-	-	15	ns	
Turn-Off Delay Time (Notes 8 & 9)	t _{D(OFF)}	-	-	12	ns	
Turn-Off Fall Time (Notes 8 & 9)	t _F	-	-	15	ns	

- Notes:
5. For a device surface mounted on 25mm x 25mm FR-4 PCB with high coverage of single sided 1oz copper, in still air conditions.
 6. Repetitive rating - pulse width limited by maximum junction temperature. Refer to Transient Thermal Impedance graph.
 7. Measured under pulsed conditions. Pulse width ≤ 300µs. Duty cycle ≤ 2%.
 8. Sample test.
 9. Switching characteristics are independent of operating junction temperature.

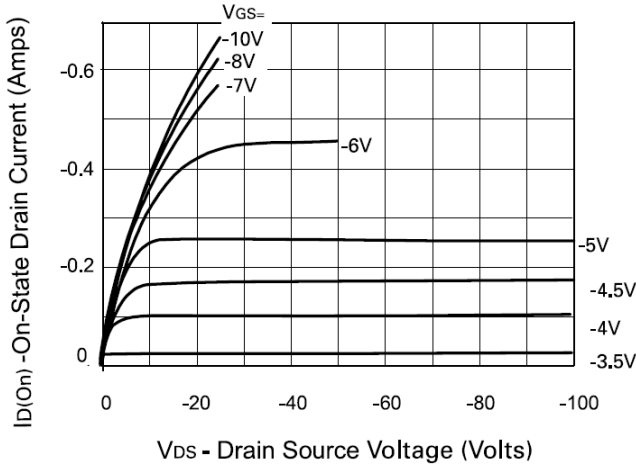

Output Characteristics

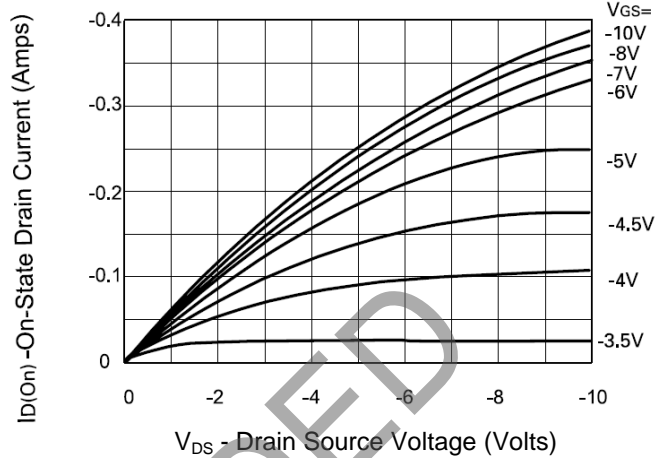

Saturation Characteristics

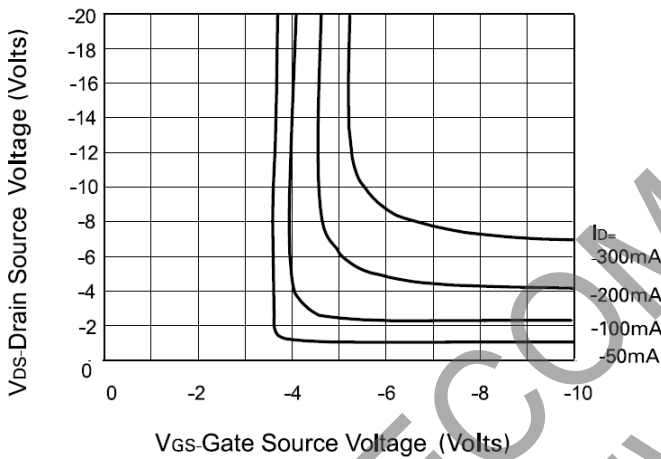

Voltage Saturation Characteristics

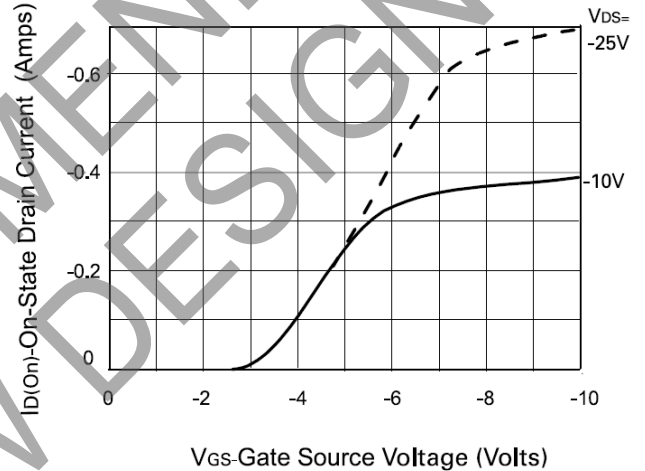

Transfer Characteristics

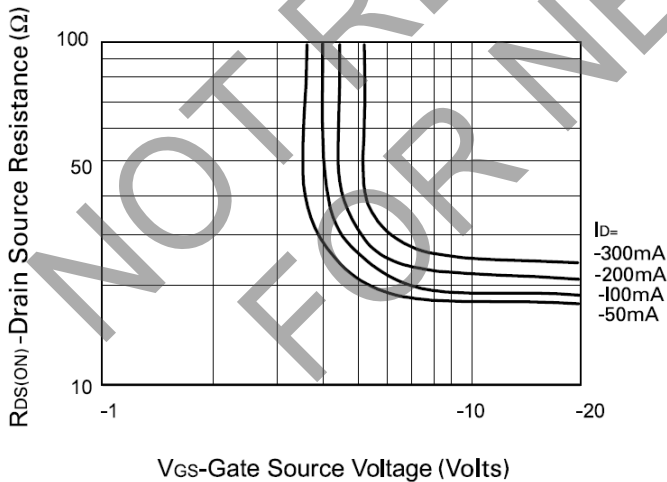

On-resistance vs gate-source voltage

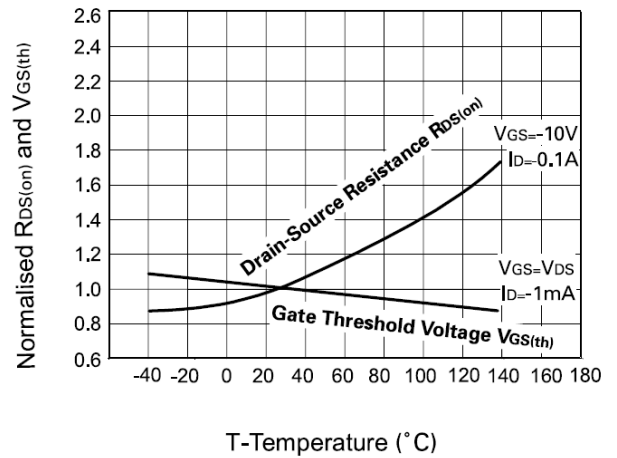

Normalised $R_{DS(on)}$ and $V_{GS(th)}$ vs Temperature

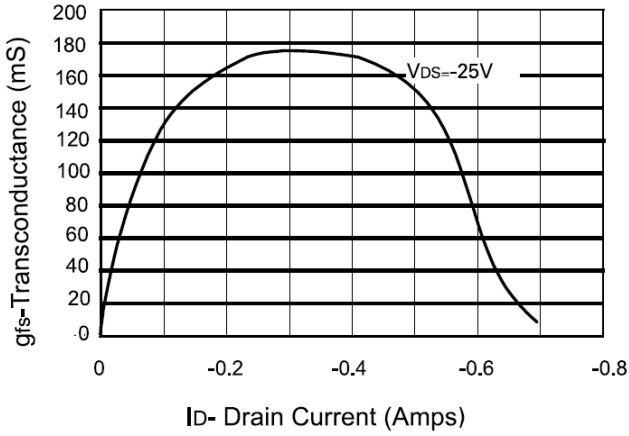

Transconductance v drain current

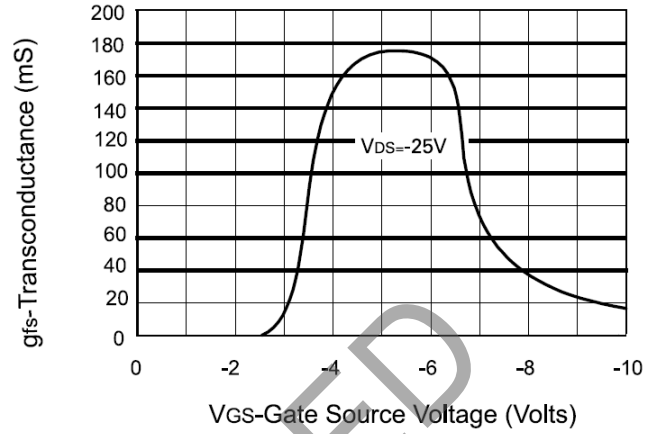

Transconductance v gate-source voltage

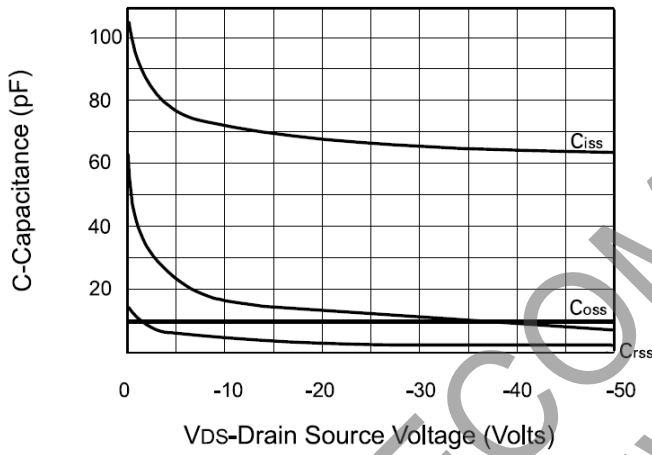

Capacitance v drain-source voltage

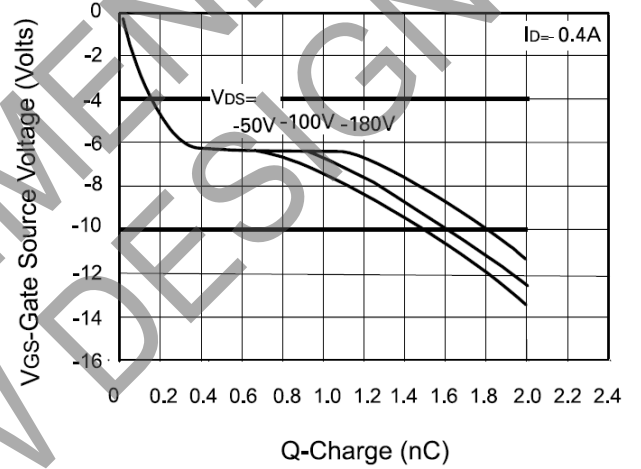

Gate charge v gate-source voltage

NOT RECOMMENDED FOR NEW DESIGN

Thermal Characteristics

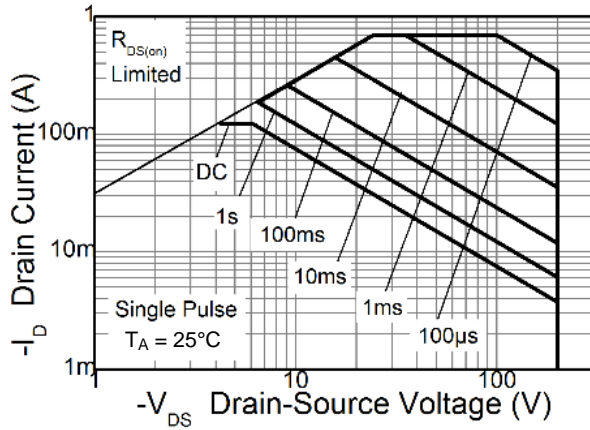

Safe Operating Area

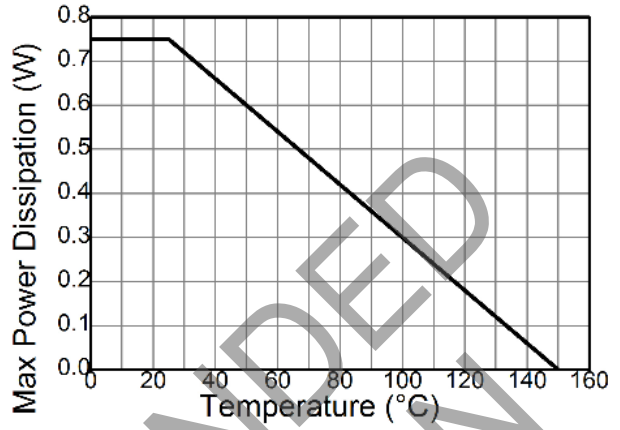

Derating Curve

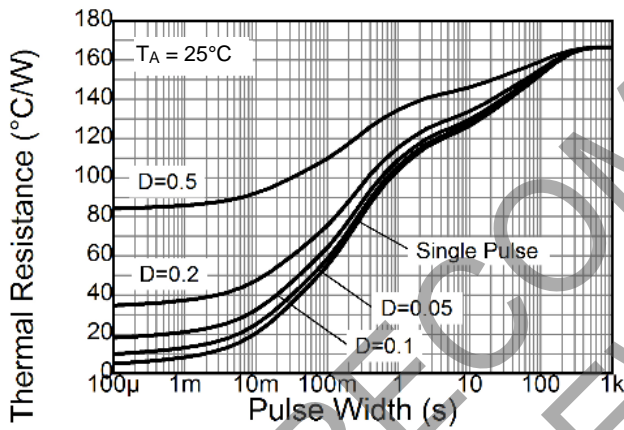

Transient Thermal Impedance

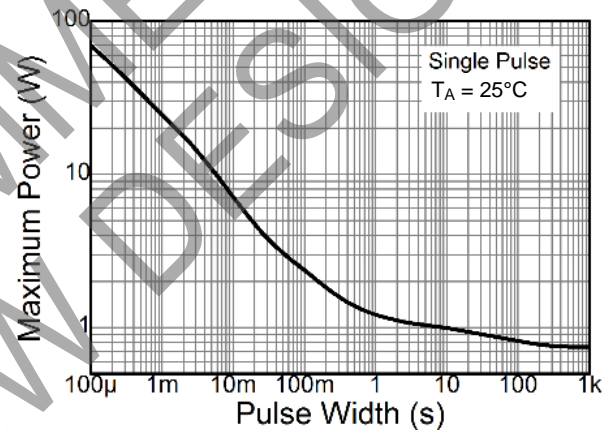

Pulse Power Dissipation

Package Outline Dimensions

Please see <http://www.diodes.com/package-outlines.html> for the latest version.

SOT25

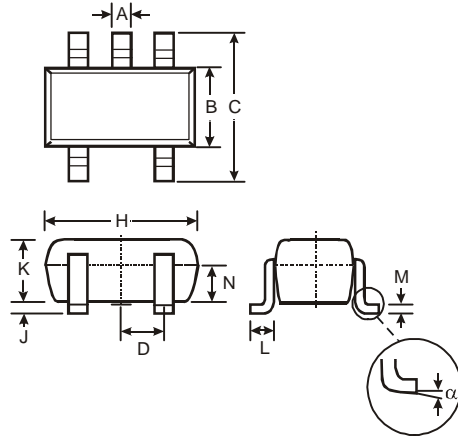

SOT25			
Dim	Min	Max	Typ
A	0.35	0.50	0.38
B	1.50	1.70	1.60
C	2.70	3.00	2.80
D	-	-	0.95
H	2.90	3.10	3.00
J	0.013	0.10	0.05
K	1.00	1.30	1.10
L	0.35	0.55	0.40
M	0.10	0.20	0.15
N	0.70	0.80	0.75
α	0°	8°	-
All Dimensions in mm			

Suggested Pad Layout

Please see <http://www.diodes.com/package-outlines.html> for the latest version.

SOT25

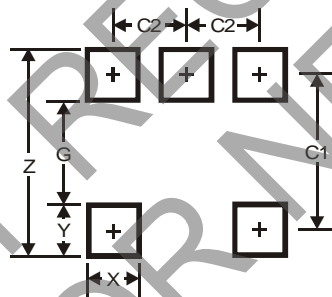

Dimensions	SOT25
Z	3.20
G	1.60
X	0.55
Y	0.80
C1	2.40
C2	0.95

IMPORTANT NOTICE

DIODES INCORPORATED MAKES NO WARRANTY OF ANY KIND, EXPRESS OR IMPLIED, WITH REGARDS TO THIS DOCUMENT, INCLUDING, BUT NOT LIMITED TO, THE IMPLIED WARRANTIES OF MERCHANTABILITY AND FITNESS FOR A PARTICULAR PURPOSE (AND THEIR EQUIVALENTS UNDER THE LAWS OF ANY JURISDICTION).

Diodes Incorporated and its subsidiaries reserve the right to make modifications, enhancements, improvements, corrections or other changes without further notice to this document and any product described herein. Diodes Incorporated does not assume any liability arising out of the application or use of this document or any product described herein; neither does Diodes Incorporated convey any license under its patent or trademark rights, nor the rights of others. Any Customer or user of this document or products described herein in such applications shall assume all risks of such use and will agree to hold Diodes Incorporated and all the companies whose products are represented on Diodes Incorporated website, harmless against all damages.

Diodes Incorporated does not warrant or accept any liability whatsoever in respect of any products purchased through unauthorized sales channel. Should Customers purchase or use Diodes Incorporated products for any unintended or unauthorized application, Customers shall indemnify and hold Diodes Incorporated and its representatives harmless against all claims, damages, expenses, and attorney fees arising out of, directly or indirectly, any claim of personal injury or death associated with such unintended or unauthorized application.

Products described herein may be covered by one or more United States, international or foreign patents pending. Product names and markings noted herein may also be covered by one or more United States, international or foreign trademarks.

This document is written in English but may be translated into multiple languages for reference. Only the English version of this document is the final and determinative format released by Diodes Incorporated.

LIFE SUPPORT

Diodes Incorporated products are specifically not authorized for use as critical components in life support devices or systems without the express written approval of the Chief Executive Officer of Diodes Incorporated. As used herein:

A. Life support devices or systems are devices or systems which:

1. are intended to implant into the body, or
2. support or sustain life and whose failure to perform when properly used in accordance with instructions for use provided in the labeling can be reasonably expected to result in significant injury to the user.

B. A critical component is any component in a life support device or system whose failure to perform can be reasonably expected to cause the failure of the life support device or to affect its safety or effectiveness.

Customers represent that they have all necessary expertise in the safety and regulatory ramifications of their life support devices or systems, and acknowledge and agree that they are solely responsible for all legal, regulatory and safety-related requirements concerning their products and any use of Diodes Incorporated products in such safety-critical, life support devices or systems, notwithstanding any devices- or systems-related information or support that may be provided by Diodes Incorporated. Further, Customers must fully indemnify Diodes Incorporated and its representatives against any damages arising out of the use of Diodes Incorporated products in such safety-critical, life support devices or systems.

Copyright © 2018, Diodes Incorporated

www.diodes.com